

Features

- Planar Die Construction
- 200mW Power Dissipation
- 2.4V – 51V Nominal Zener Voltage
- 5% Standard Vz Tolerance
- Designed for Surface Mount Application
- Plastic Material – UL Recognition Flammability Classification 94V-0

Mechanical Data

- Case: SOT-323, Molded Plastic
- Terminals: Plated Leads Solderable per MIL-STD-202, Method 208
- Polarity: See Diagram
- Weight: 0.006 grams (approx.)
- Mounting Position: Any
- Marking: Device Code
- **Lead Free: For RoHS / Lead Free Version, Add “-LF” Suffix to Part Number, See Page 5**

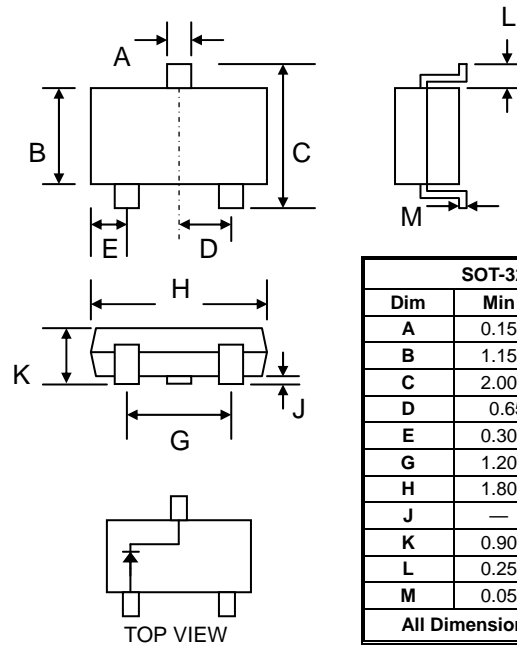

SOT-323		
Dim	Min	Max
A	0.15	0.40
B	1.15	1.35
C	2.00	2.30
D	0.65 Nominal	
E	0.30	0.40
G	1.20	1.40
H	1.80	2.20
J	—	0.10
K	0.90	1.10
L	0.25	—
M	0.05	0.15
All Dimensions in mm		

Maximum Ratings @ $T_A=25^\circ\text{C}$ unless otherwise specified

Characteristic	Symbol	Value	Unit
Peak Pulse Power Dissipation at $T_A = 25^\circ\text{C}$ (Note 1)	P_D	200	mW
Forward Voltage @ $I_F = 10\text{mA}$	V_F	0.9	V
Thermal Resistance Junction to Ambient (Note 1, 2)	R_{JA}	625	$^\circ\text{C/W}$
Operating and Storage Temperature Range	T_j, T_{STG}	-65 to +150	$^\circ\text{C}$

Note: 1. Mounted on FR-4 PCB with minimum recommended pad layout.
 2. Thermal resistance measurement obtained via infrared scan method.

BZX84C2V4W – BZX84C51W

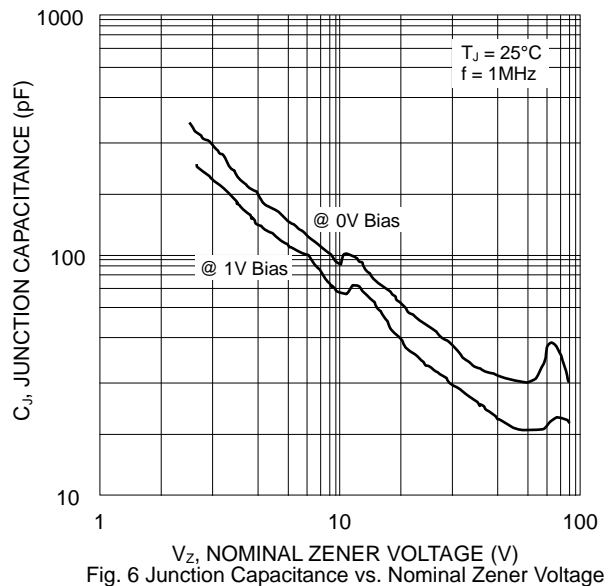
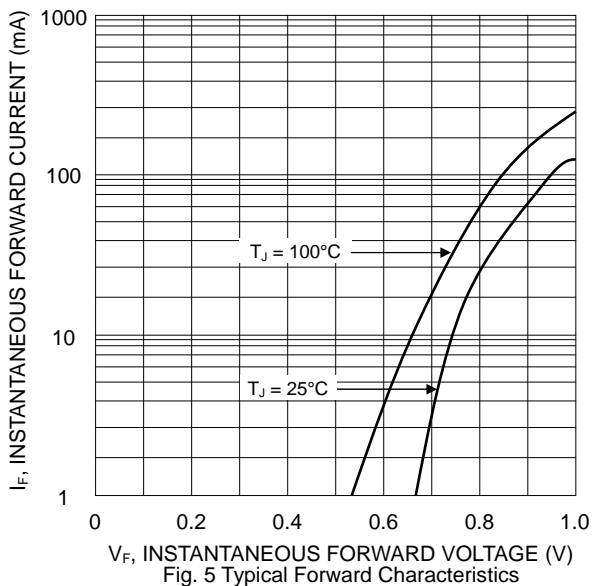
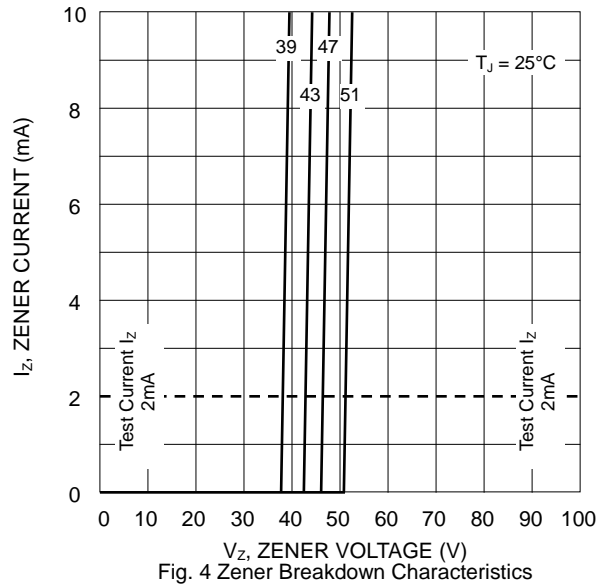
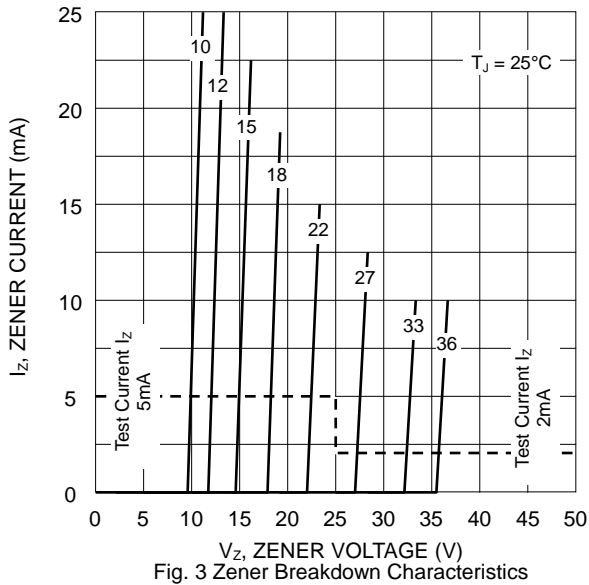
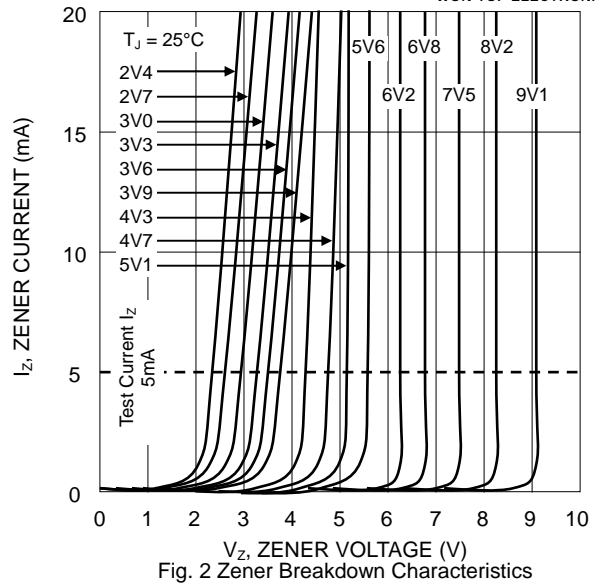
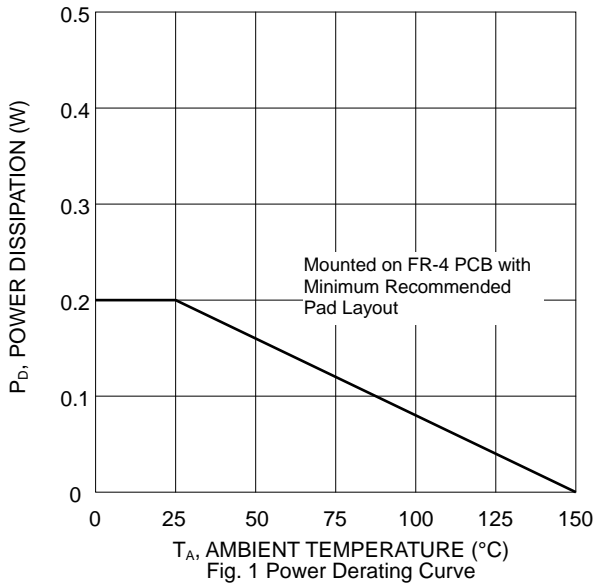

Electrical Characteristics (@T_A=25°C unless otherwise specified) Table 1

Type Number (Note 1)	Device Marking Code (Note 2)		Zener Voltage Range (Note 3)			Maximum Zener Impedance (Note 4)				Max Reverse Leakage Current		Temp. Coefficient of Zener Voltage @ I _{ZT} (mV/K)	
			V _Z @ I _{ZT}			Z _{ZT} @ I _{ZT}		Z _{ZK} @ I _{ZK}		I _R	@ V _R		
	TW	CN	Nom (V)	Min (V)	Max (V)	()	(mA)	()	(mA)	(μA)	(V)	Min	Max
BZX84C2V4W	W1	KRB	2.4	2.2	2.6	100	5.0	600	1.0	50	1.0	-3.5	0
BZX84C2V7W	W2	KRC	2.7	2.5	2.9	100	5.0	600	1.0	20	1.0	-3.5	0
BZX84C3V0W	W3	KRD	3.0	2.8	3.2	95	5.0	600	1.0	10	1.0	-3.5	0
BZX84C3V3W	W4	KRE	3.3	3.1	3.5	95	5.0	600	1.0	5.0	1.0	-3.5	0
BZX84C3V6W	W5	KRF	3.6	3.4	3.8	90	5.0	600	1.0	5.0	1.0	-3.5	0
BZX84C3V9W	W6	KRG	3.9	3.7	4.1	90	5.0	600	1.0	3.0	1.0	-3.5	0
BZX84C4V3W	W7	KRH	4.3	4.0	4.6	90	5.0	600	1.0	3.0	1.0	-3.5	0
BZX84C4V7W	W8	KR1	4.7	4.4	5.0	80	5.0	500	1.0	3.0	2.0	-3.5	0.2
BZX84C5V1W	W9	KR2	5.1	4.8	5.4	60	5.0	480	1.0	2.0	2.0	-2.7	1.2
BZX84C5V6W	WA	KR3	5.6	5.2	6.0	40	5.0	400	1.0	1.0	2.0	-2.0	2.5
BZX84C6V2W	WB	KR4	6.2	5.8	6.6	10	5.0	150	1.0	3.0	4.0	0.4	3.7
BZX84C6V8W	WC	KR5	6.8	6.4	7.2	15	5.0	80	1.0	2.0	4.0	1.2	4.5
BZX84C7V5W	WD	KR6	7.5	7.0	7.9	15	5.0	80	1.0	1.0	5.0	2.5	5.3
BZX84C8V2W	WE	KR7	8.2	7.7	8.7	15	5.0	80	1.0	0.7	5.0	3.2	6.2
BZX84C9V1W	WF	KR8	9.1	8.5	9.6	15	5.0	100	1.0	0.5	6.0	3.8	7.0
BZX84C10W	WG	KR9	10	9.4	10.6	20	5.0	150	1.0	0.2	7.0	4.5	8.0
BZX84C11W	WH	KP1	11	10.4	11.6	20	5.0	150	1.0	0.1	8.0	5.4	9.0
BZX84C12W	WI	KP2	12	11.4	12.7	25	5.0	150	1.0	0.1	8.0	6.0	10.0
BZX84C13W	WK	KP3	13	12.4	14.1	30	5.0	170	1.0	0.1	8.0	7.0	11.0
BZX84C15W	WL	KP4	15	13.8	15.6	30	5.0	200	1.0	0.05	10.5	9.2	13.0
BZX84C16W	WM	KP5	16	15.3	17.1	40	5.0	200	1.0	0.05	11.2	10.4	14.0
BZX84C18W	WN	KP6	18	16.8	19.1	45	5.0	225	1.0	0.05	12.6	12.4	16.0
BZX84C20W	WO	KP7	20	18.8	21.2	55	5.0	225	1.0	0.05	14.0	14.4	18.0
BZX84C22W	WP	KP8	22	20.8	23.3	55	5.0	250	1.0	0.05	15.4	16.4	20.0
BZX84C24W	WR	KP9	24	22.8	25.6	70	5.0	250	1.0	0.05	16.8	18.4	22.0
BZX84C27W	WS	KPA	27	25.1	28.9	80	2.0	300	0.5	0.05	18.9	21.4	25.3
BZX84C30W	WT	KPB	30	28.0	32.0	80	2.0	300	0.5	0.05	21.0	24.4	29.4
BZX84C33W	WU	KPC	33	31.0	35.0	80	2.0	325	0.5	0.05	23.1	27.4	33.4
BZX84C36W	WW	KPD	36	34.0	38.0	90	2.0	350	0.5	0.05	25.2	30.4	37.4
BZX84C39W	WX	KPE	39	37.0	41.0	130	2.0	350	0.5	0.05	27.3	33.4	41.2
BZX84C43W	WY	KPF	43	40.0	46.0	150	2.0	375	0.5	0.05	30.1	37.6	46.6
BZX84C47W	WZ	KPG	47	44.0	50.0	170	2.0	375	0.5	0.05	32.9	42.0	51.8
BZX84C51W	XA	KPH	51	48.0	54.0	180	2.0	400	0.5	0.05	35.7	46.6	57.2

- Note: 1. Type numbers listed have standard tolerance on the nominal zener voltage of ±5%.
 2. TW: Marking code for Taiwan plant. CN: Marking code for China plant.
 3. Measured with pulse test current I_Z at ambient temperature 25°C.
 4. f = 1KHz

MARKING INFORMATION

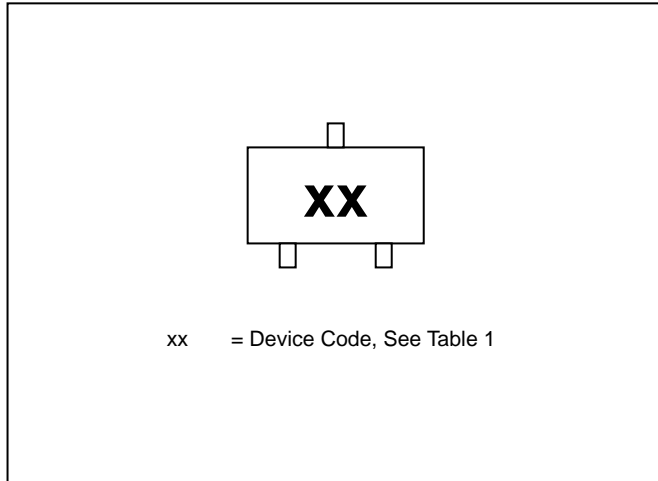

RECOMMENDED FOOTPRINT

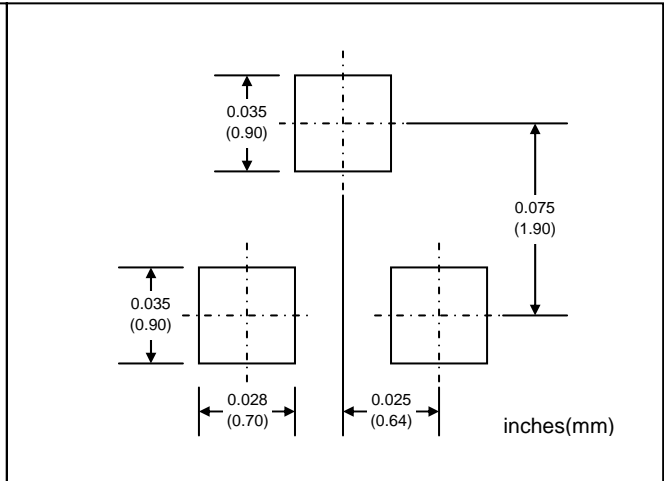

PACKAGING INFORMATION

TAPE & REEL

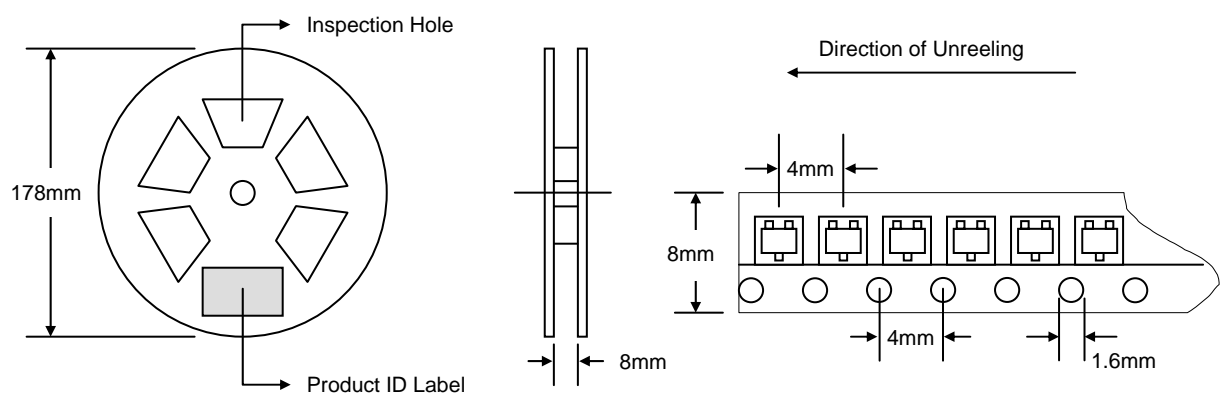

Reel Diameter (mm)	Quantity (PCS)	Inner Box Size L x W x H (mm)	Quantity (PCS)	Carton Size L x W x H (mm)	Quantity (PCS)	Approx. Gross Weight (KG)
178	3,000	187 x 187 x 65	15,000	390 x 240 x 420	150,000	10.0

Note: 1. Anti-static plastic reel, white, water clear or blue color. Inspection hole might be varied in different alignment.
2. Components are packed in accordance with EIA standard 481-1 and 481-2.

ORDERING INFORMATION

Product No.	Package Type	Shipping Quantity
BZX84CxxW-T1	SOT-323	3000/Tape & Reel

1. Shipping quantity given is for minimum packing quantity only. For minimum order quantity, please consult the Sales Department.
2. **To order RoHS / Lead Free version (with Lead Free finish), add “-LF” suffix to part number above. For example, BZX84C2V4W-T1-LF.**

WON-TOP ELECTRONICS and  are registered trademarks of Won-Top Electronics Co., Ltd (WTE). WTE has checked all information carefully and believes it to be correct and accurate. However, WTE cannot assume any responsibility for inaccuracies. Furthermore, this information does not give the purchaser of semiconductor devices any license under patent rights to manufacturer. WTE reserves the right to change any or all information herein without further notice.

WARNING: DO NOT USE IN LIFE SUPPORT EQUIPMENT. WTE power semiconductor products are not authorized for use as critical components in life support devices or systems without the express written approval.

Won-Top Electronics Co., Ltd.
No. 44 Yu Kang North 3rd Road,
Chine Chen Dist., Kaohsiung 806, Taiwan
Phone: 886-7-822-5408 or 886-7-822-5410
Fax: 886-7-822-5417
Email: sales@wontop.com
Internet: <http://www.wontop.com>

We power your everyday.