

Typical Applications

Base Stations
 Test Equipment
 Synthesizers

Features

Surface Mount Package
 Reflow Process Compatible
 AT-Cut Crystal
 SONET Minimum Clock Specification

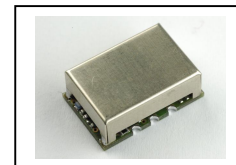

Previous Vectron Model Numbers

SPO50, 9140

Frequency range

8 MHz – 700 MHz

Standard frequencies

10; 24.705; 30.720; 32.768; 50; 68.768 MHz;
 77.76 MHz; 155.52; 622,08 MHz

Frequency stabilities¹ [Standard]

Parameter	Min	Typ	Max.	Units	Operating temp range	Ordering Code ⁵
vs. operating temperature range (Referenced to +25°C)	-10.0		+10.0	ppm	-20 ... +70°C	D105
Parameter	Min	Typ	Max.	Units	Condition	
Initial tolerance	-5.0		+5.0	ppm	V _S ± 5% Load ± 5%	
vs. supply voltage change	-1.0		+1.0	ppm		
vs. load change	-1.0		+1.0	ppm		
vs. aging /1. Year	-3.0		+3.0	ppm		
vs. aging / year (following Years)	-1.0		+1.0	ppm		

Frequency stabilities¹ [meets SONET Minimum Clock Specification - Option]

Parameter	Min	Typ	Max.	Units	Operating temp range	Ordering Code ⁵
vs. operating temperature range					-20 ... +70°C	D205
Parameter	Min	Typ	Max.	Units	Condition	
overall tolerance	-20.0		+20.0	ppm	(15 Years aging, temp, initial, supply, load)	

Supply voltage

Parameter	Min	Typ	Max.	Units	Condition	Ordering Code ⁵
Supply voltage (Vs)	4.75	5.0	5.25	VDC		SV050
Current consumption			40	mA	@ HCMOS < 155 MHz	
Current consumption			90	mA	@ PECL < 155 MHz	
Supply voltage (Vs)	3.135	3.3	3.465	VDC		SV033
Current consumption			30	mA	@ LVHCMOS < 155 MHz	
Current consumption			80	mA	@ LVPECL < 155 MHz	
Current consumption			25	mA	@ LVDS < 155 MHz	

RF output

Parameter	Min	Typ	Max.	Units	Condition	Ordering Code ⁵
Signal	HCMOS				@ 15 pF 10 to 90 % @ Vs/2	RFH
Load		15.0		pF		
Rise and Fall time			5	ns		
Duty cycle	40		60	%		
Signal	PECL				Vs - 2V 20 to 80 %	RFP
Load		50		Ω		
Rise and Fall time			1	ns		
Duty cycle	45		55	%		
Signal	LVDS				10 to 90 %	RFL
Load		100		Ω		
Rise and Fall time			1	ns		
Duty cycle	40		60	%		

Additional parameters

Parameter	Min	Typ	Max.	Units	Condition
Phase Noise		-75		dBc/Hz	10 Hz @155 MHz
		-110		dBc/Hz	100 Hz PECL
		-135		dBc/Hz	1 kHz 3,3V
		-142		dBc/Hz	10 kHz
		-142		dBc/Hz	100 kHz
Jitter		1		ps RMS	@ 10 kHz to 20 MHz
Weight			2	g	
Processing & Packing	handling&processing note				

Enclosures

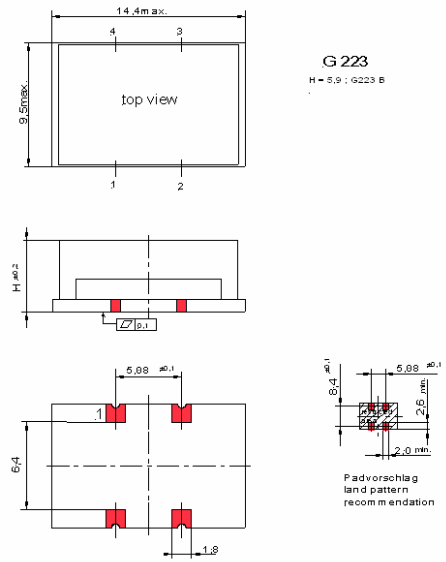
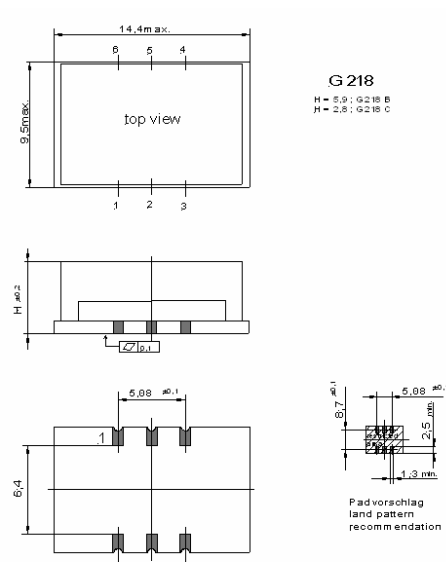
Type G223A for HCMOS and LVHCMOS Version			Type G218B for PECL; LVPECL and LVDS Version		
Package Codes:					
Code A1	Height "H" 5,9	Pin Length "L" NA	Code B1	Height "H" 5,9	Pin Length "L" NA
 <p>Dimensions: mm</p>			 <p>Dimensions: mm</p>		

 Vectron International · www.vectron.com

v.2005-11-09 · page 2 of 5

 Vectron International
 Headquarters
 267 Lowell Road
 Hudson, New Hampshire 03051
 +1-888-328-7661 tel
 +1-888-329-8328 fax

 Vectron International LLC.
 100 Watts Street
 Mount Holly Springs, PA 17065
 USA
 +1-717-486-3411 tel
 +1-717-486-5920 fax

 Vectron international GmbH & Co. KG
 Landstrasse
 D-74924 Neckarbischofsheim
 Germany
 +49-07268-801-0 tel
 +49-07268-801-281 fax

 Vectron Asia Pacific Sales Office
 1F-2F, No 8 Workshop, No 308 Fenju Road,
 WaiGaoQiao Free Trade Zone, Pudong,
 Shanghai, P.R. China 200131
 +86 21 5048 0777 tel.
 +86 21 5048 1881 fax

<p style="text-align: center;">Pin Connections</p> <p>1 NC / Enable (optional) 2 Ground (Case) 3 RF Output 4 Supply Voltage Input (Vs)</p> <p>Outline Drawing: G223B</p>	<p style="text-align: center;">Pin Connections</p> <p>1 N/C 2 N/C / Enable (optional) 3 Ground (Case) 4 RF Output 5 Complementary RF Output 6 Supply Voltage Input (Vs)</p> <p>Outline Drawing: G218B</p>
<p>Marking</p> <p>C1310A1-xxxx frequency * VI AYYWW</p>	

Absolute Maximum Ratings

Parameter	Min	Typ	Max.	Units	Condition
Supply voltage (Vs)			7	V	
Operable temperature range	-30		+80	°C	
Storage temperature range	-40		+90	°C	

Typical Phase Noise and Jitter

(52 MHz; HCMOS output)

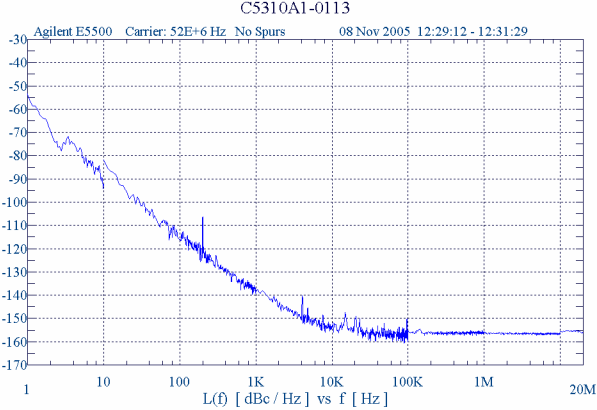

(155,52 MHz; PECL output)

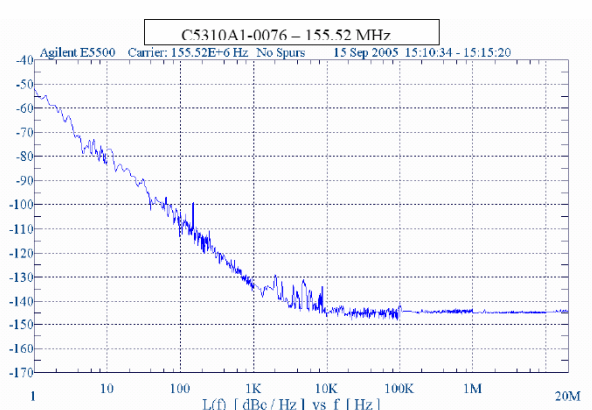

Frequency range [Hz]	S ₀ (f) [dB]	Jitter [ps rms]	Frequency range [Hz]	S ₀ (f) [dB]	Jitter [ps rms]
100Hz to 1.5MHz	-77dB	0.432ps	500Hz to 1.5MHz	-73.96dB	0.205ps
50kHz to 1.5MHz	-91dB	0.086ps	65kHz to 1.5MHz	-75.87dB	0.165ps
12kHz to 20MHz	-80dB	0.306ps	12kHz to 20MHz	-65.34dB	0.553ps

Typical Phase Noise and Jitter (122,88MHz; LVDS output)

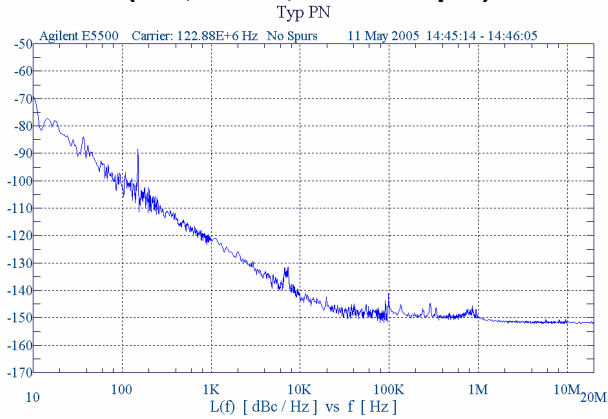

(622,08MHz; PECL output)

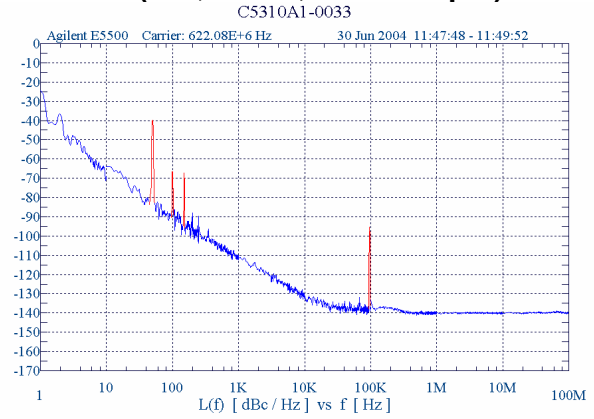

Frequency range [Hz]	S ϕ (f) [dB]	Jitter [ps rms]
100Hz to 1.5MHz	-75dB	0.230ps
50kHz to 1.5MHz	-84dB	0.082ps
12kHz to 20MHz	-75dB	0.230ps

Frequency range [Hz]	S ϕ (f) [dB]	Jitter [ps rms]
1kHz to 5MHz	-67.09dB	0.113ps
250kHz to 5MHz	-68.18dB	0.100ps
12kHz to 20MHz	-61.95dB	0.204ps

Typical frequency stability vs temp

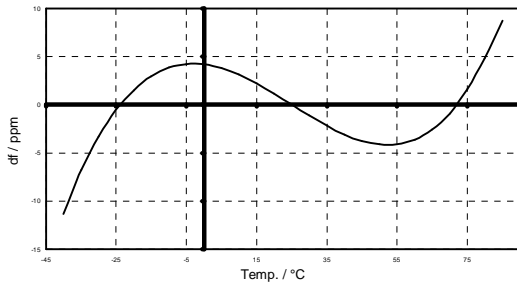

Standard Shipping Method

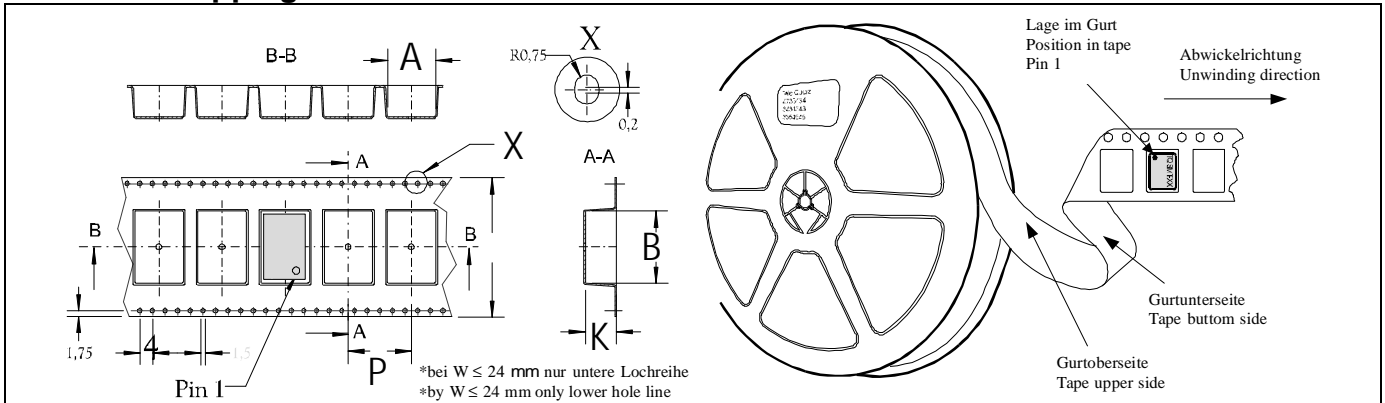

Production tolerance complying DIN IEC 286-3

Enclosure Type	Tape width W [mm]	Quantity per meter	Quantity per reel	Dimension P
G218B / G223B	24	83,3	850	12

Recommended Reflow Profile

Solderprofile:

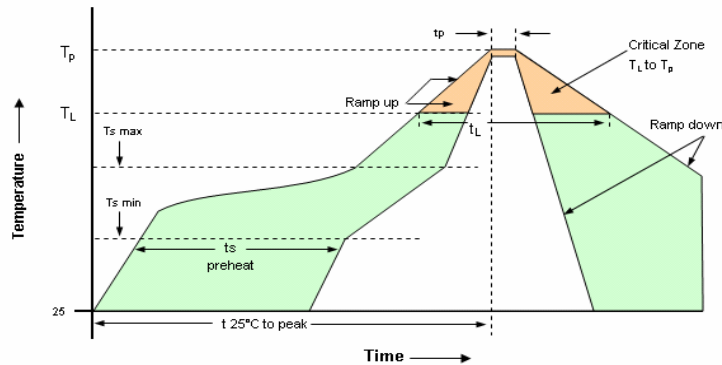

Profile Feature	Pb-Free Assembly /Sn-Pb Assembly	Profile Feature	Pb-Free Assembly /Sn-Pb Assembly
Average ramp-up rate (T_L to T_p)	3°C/second max.	Time 25°C to Peak Temperature	8 minutes max.
Preheat - Temperature Min $T_{s_{min}}$ - Temperature Min $T_{s_{max}}$ - Time (min to max) (t_s)	150°C 200°C 60-180 seconds	Time maintained above - Temperature (T_L) - Time (t_L)	217°C 60-150 seconds
$T_{s_{max}}$ to T_L - Ramp-up Rate	3°C/second max.		
Time maintained above - Temperature (T_L) - Time (t_L)	217°C 60-150 seconds	Time within 5°C of actual Peak Temperature (t_p)	20-40 seconds
Peak Temperature (T_p)	max 260°C	Ramp-down Rate	6°C/second max.

Note: All temperatures refer to topside of the package, measured on the package body surface.
SMD oscillators must be on the top side of the PCB during the reflow process.

How to Order this Product:

Step 1	Use this worksheet to forward the following information to your factory representative:				
	Model	Stability Code	Supply Voltage Code	RF Output Code	Package Code
	C1310				
Example:	C1310	D105	SV050	RFH	A1

Step 2	The factory representative will then respond with a Vectron Model Number in the following Configuration:			
	Model	Package Code	Dash	Dash Number
	C1310	[Customer Specified Package Code]	-	[Factory Generated 4 digit number]

Typical P/N = C1310A1-0001

Notes:

- 1 Contact factory for improved stabilities or additional product options. Not all options and codes are available at all frequencies.
- 2 Unless otherwise stated all values are valid after warm-up time and refer to typical conditions for supply voltage, frequency control voltage, load, temperature (25°C)
- 3 Phase noise degrades with increasing output frequency.
- 4 Subject to technical modification.
- 5 Contact factory for availability.