

High Power Silicon Controlled Rectifier

1200 Volts 63A RMS

C147

C147 Silicon Controlled Rectifier is designed for phase control applications. This is an all-diffused device which is considerably smaller in size than comparably rated high power SCR's.



FEATURES:

- High dv/dt With Selections Available
- Excellent Surge and I²t Ratings, Providing Easy Fusing
- Compact, Hermetic Package, 1/4–28 Stud



SOLID STATE INC.

46 FARRAND STREET
BLOOMFIELD, NEW JERSEY 07003

www.solidstateinc.com

MAXIMUM ALLOWABLE RATINGS

TYPE	REPETITIVE PEAK OFF-STATE VOLTAGE, V _{DRM} ¹ T _J = -40°C to +125°C	REPETITIVE PEAK REVERSE VOLTAGE, V _{RRM} ¹ T _J = -40°C to +125°C	NON-REPETITIVE PEAK REVERSE VOLTAGE, V _{RSM} ¹ T _J = +125°C
C147A	100 Volts	100 Volts	150 Volts
C147B	200	200	300
C147C	300	300	400
C147D	400	400	500
C147E	500	500	600
C147M	600	600	720
C147S	700	700	840
C147N	800	800	960
C147T	900	900	1080
C147P	1000	1000	1200
C147PA	1100	1100	1320
C147PB	1200	1200	1440

¹ Half sinewave waveform, 10 msec. maximum pulse width.

RMS On-State Current, I _{T(RMS)}	63 Amperes (All Conduction Angles)
Average On-State Current, I _{T(AV)}	Depends on Conduction Angles (See Charts 2 and 3)
Critical Rate-of-Rise of On-State Current (Non-Repetitive) di/dt:*	
Switching From 1200 Volts	100 Amperes Per Microsecond
Switching From 600 Volts	200 Amperes Per Microsecond
Peak One-Cycle Surge (Non-Repetitive) On-State Current, I _{TSM} (60 Hz)	1000 Amperes
Peak One-Cycle Surge (Non-Repetitive) On-State Current, I _{TSM} (50 Hz)	910 Amperes
I ² t (for fusing), for times ≥ 8.3 milliseconds (See Figure 6)	4150 (RMS Ampere) ² Seconds
I ² t (for fusing), for times ≥ 1.5 milliseconds (See Figure 6)	2850 (RMS Ampere) ² Seconds
Peak Gate Power Dissipation, P _{GM}	100 Watts for 150 Microseconds
Average Gate Power Dissipation, P _{G(AV)}	2 Watts
Storage Temperature, T _{stg}	-40°C to +150°C
Operating Temperature, T _J	-40°C to +125°C
Maximum Stud Torque	30 Lb.-In. 3-4 N-m

*di/dt ratings established in accordance with EIA-NEMA Standard RS-397, Section 5.2.2.6 for conditions of V_{DRM} stated above; 20 volts, 20 ohms gate trigger source with 0.5 μsec short circuit trigger current rise time.

CHARACTERISTICS

TEST	SYMBOL	MIN.	TYP.	MAX.	UNITS	TEST CONDITIONS
Peak Off-State and Reverse Current	I_{DRM} and I_{RRM}				mA	$T_J = -40^\circ\text{C}$ to $+125^\circ\text{C}$ $V_{DRM} = V_{RRM} =$
C147A		—	—	12		100 Volts Peak
C147B		—	—	12		200
C147C		—	—	12		300
C147D		—	—	10		400
C147E		—	—	10		500
C147M		—	—	10		600
C147S		—	—	10		700
C147N		—	—	9		800
C147T		—	—	8		900
C147P		—	—	7		1000
C147PA		—	—	6.5		1100
C147PB		—	—	6		1200
DC Gate Trigger Current	I_{GT}	—	—	150	mAdc	$T_C = 25^\circ\text{C}$, $V_D = 12\text{ Vdc}$, $R_L = 12\text{ Ohms}$
		—	—	300		$T_C = -40^\circ\text{C}$, $V_D = 12\text{ Vdc}$, $R_L = 12\text{ Ohms}$
DC Gate Trigger Voltage	V_{GT}	—	—	3	Vdc	$T_C = 25^\circ\text{C}$, $V_D = 12\text{ Vdc}$, $R_L = 12\text{ Ohms}$
		—	—	3.5		$T_C = -40^\circ\text{C}$, $V_D = 12\text{ Vdc}$, $R_L = 12\text{ Ohms}$
		0.25	—	—		$T_C = +125^\circ\text{C}$, Rated V_{DRM} , $R_L = 1000\text{ Ohms}$
Peak On-State Voltage	V_{TM}	—	—	3	Volts	$T_C = +25^\circ\text{C}$, $I_{TM} = 500\text{ Amperes Peak}$, 1 Millisecond Wide Pulse. Duty Cycle $\leq 1\%$
Holding Current	I_H	—	—	250	mAdc	$T_C = +25^\circ\text{C}$, Anode Supply = 24 Vdc, Gate Supply = 10V/20 Ohms. Initial Forward Pulse = 2 Amps., 0.1 Millisecond to 10 Milliseconds Wide.
Critical Rate-of-Rise of Off-State Voltage. (Higher values may cause device switching)	dv/dt	200	—	—	Volts/ μsec	$T_C = +125^\circ\text{C}$, Rated V_{DRM} , Using Linear Exponential Rising Waveform. Gate Open Circuited. Exponential $dv/dt = \frac{V_{DRM}}{\tau}$ (.632)
Higher minimum dv/dt selection available – consult factory.						
Thermal Resistance	$R\theta_{JC}$	—	—	.35	$^\circ\text{C/Watt}$	Junction-to-Case
Turn-Off Time	t_q	—	125	—	μsec	(1) $T_J = +125^\circ\text{C}$ (2) $I_{TM} = 150\text{ Amps. Peak}$ (3) $V_R = 50\text{ Volts Min.}$ (4) V_{DRM} (Reapplied) (5) Rate-of-Rise of Reapplied Off-State Voltage = 20V/ μsec (Linear) (6) Commutation $di/dt = 5\text{ A}/\mu\text{sec}$ (7) Repetition Rate = 1 PPS. (8) Gate Bias During Turn-Off Interval = 0 Volts, 100 Ohms

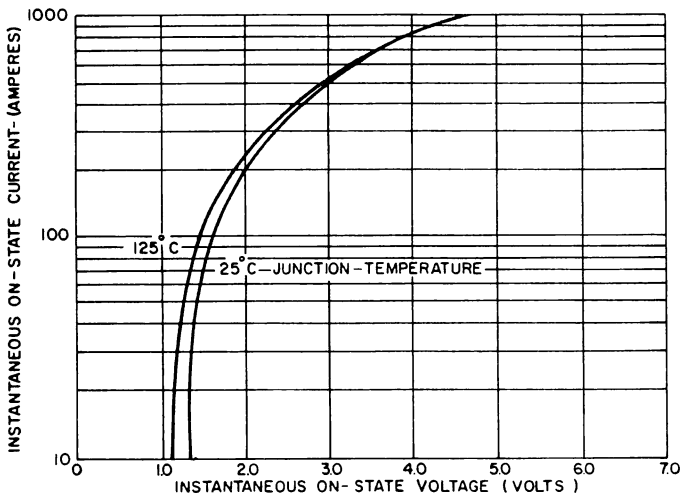

1. MAXIMUM ON-STATE CHARACTERISTICS

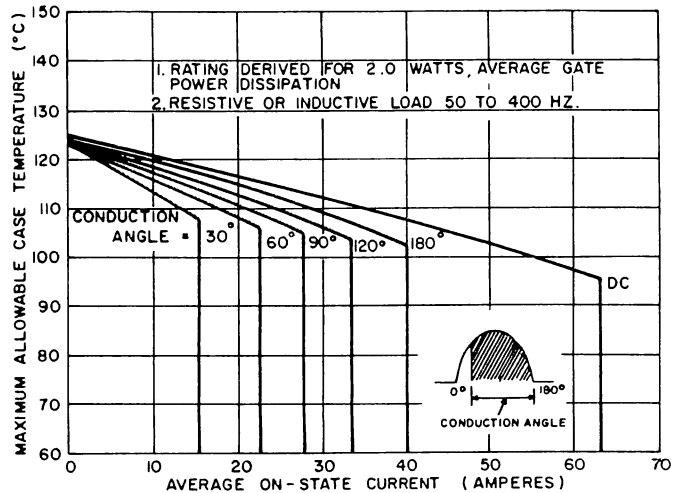

2. MAXIMUM ALLOWABLE CASE TEMPERATURE FOR SINUSOIDAL CURRENT WAVEFORM

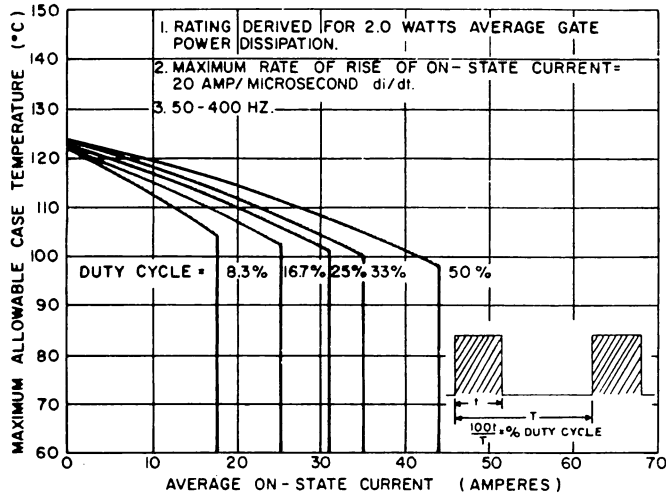

3. MAXIMUM ALLOWABLE CASE TEMPERATURE FOR RECTANGULAR CURRENT WAVEFORM

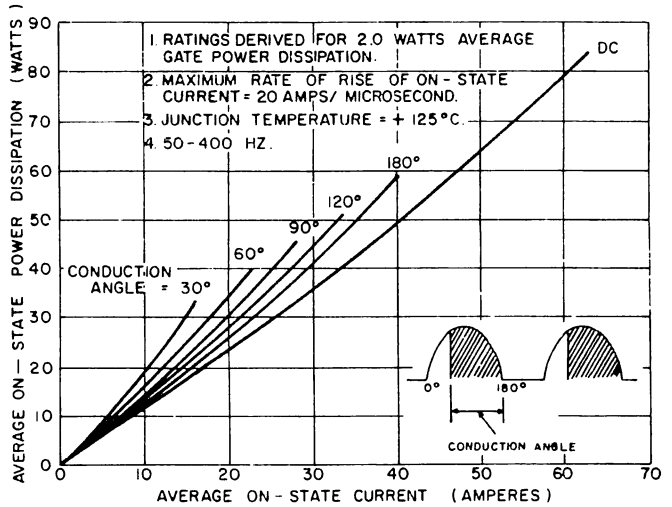

4. MAXIMUM ON-STATE POWER DISSIPATION FOR SINUSOIDAL CURRENT WAVEFORM

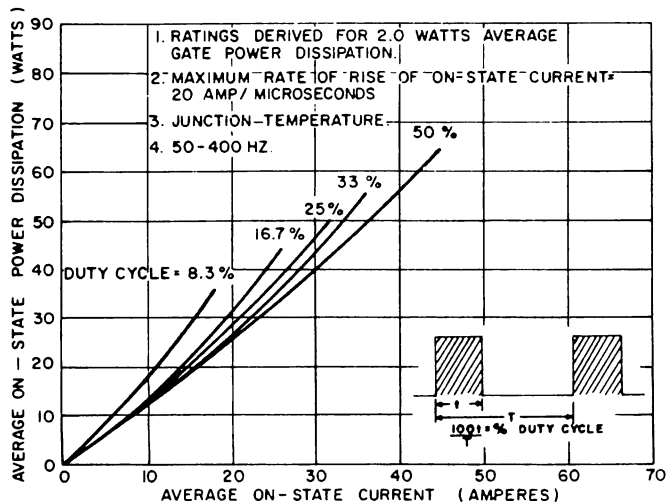

5. MAXIMUM ON-STATE POWER DISSIPATION FOR RECTANGULAR CURRENT WAVEFORM

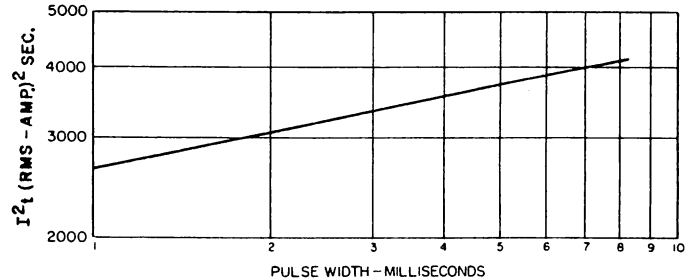

6. MAXIMUM ALLOWABLE NON-REPETITIVE SURGE CURRENT

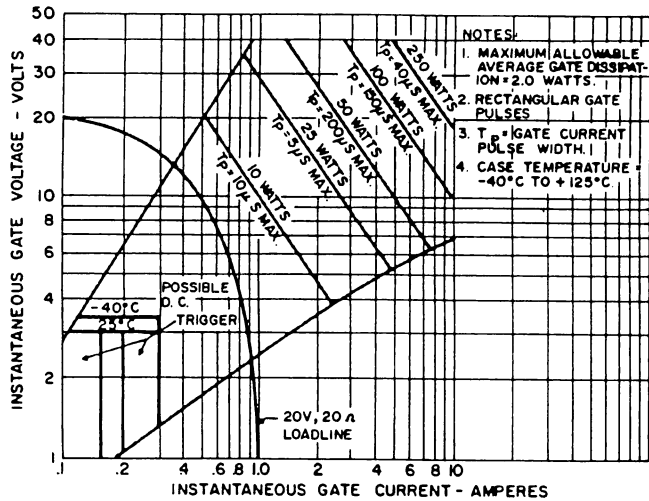

7. GATE TRIGGER CHARACTERISTICS AND POWER RATINGS

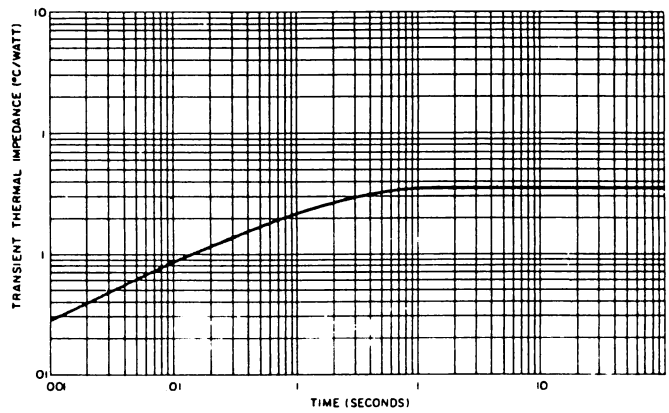

8. TRANSIENT THERMAL IMPEDANCE - JUNCTION-TO-CASE

CASE STYLE AND DIMENSIONS

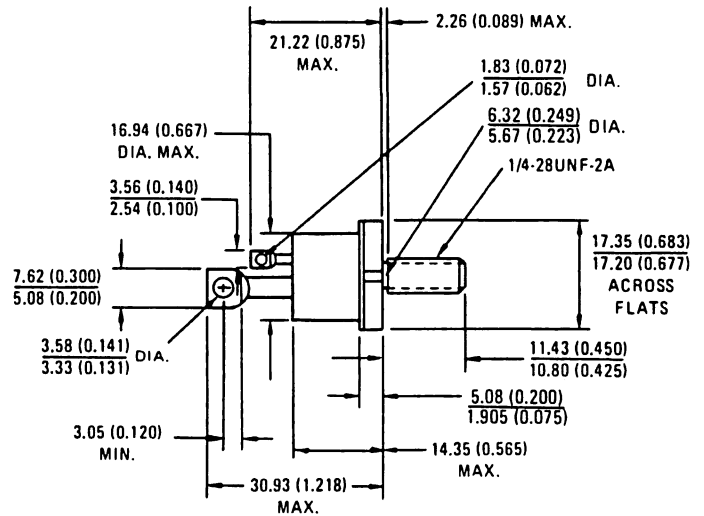
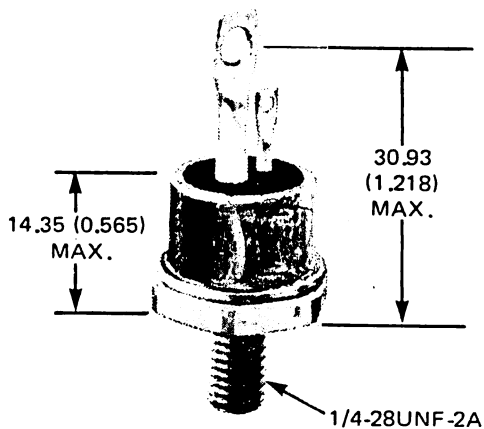

Conforms to JEDEC : TO-208AC (TO-65)

All Dimensions in Millimeters and (Inches)