

MITSUBISHI RF POWER TRANSISTOR 2SC2097

NPN EPITAXIAL PLANAR TYPE

DESCRIPTION

2SC2097 is a silicon NPN epitaxial planar type transistor designed for RF power amplifiers in HF band mobile radio applications.

FEATURES

- High power gain: $G_{pe} \geq 12.3\text{dB}$
@ $V_{CC} = 13.5\text{V}$, $P_O = 75\text{W}$, $f = 30\text{MHz}$
- Emitter ballasted construction for good performances.
- Low thermal resistance ceramic package with flange.
- Ability of withstanding infinite load VSWR when operated at $V_{CC} = 15.2\text{V}$, $P_O = 70\text{W}$, $f = 30\text{MHz}$, $T_C = 25^\circ\text{C}$.

APPLICATION

HF band linear power amplifiers in push-pull class AB operation.

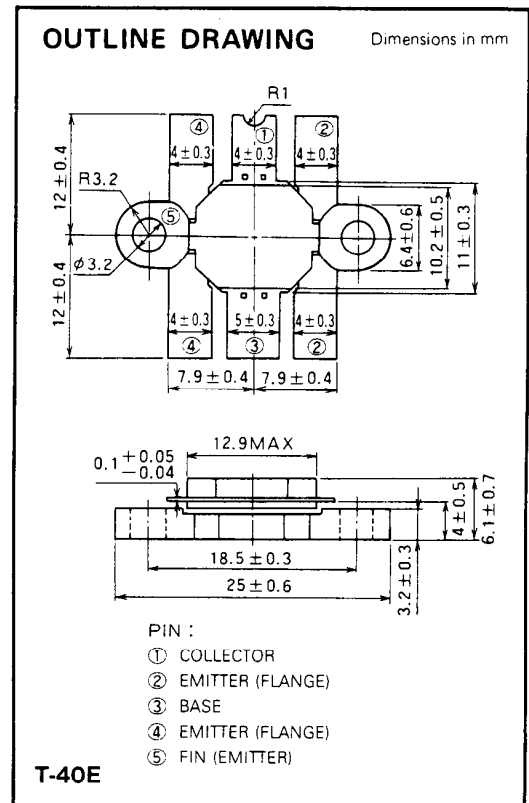

ABSOLUTE MAXIMUM RATINGS ($T_C = 25^\circ\text{C}$ unless otherwise specified)

Symbol	Parameter	Conditions	Ratings	Unit
V_{CB0}	Collector to base voltage		50	V
V_{EB0}	Emitter to base voltage		5	V
V_{CE0}	Collector to emitter voltage	$R_{BE} = \infty$	20	V
I_C	Collector current		15	A
P_C	Collector dissipation	$T_a = 25^\circ\text{C}$	7.5	W
		$T_C = 25^\circ\text{C}$	150	W
T_j	Junction temperature		175	$^\circ\text{C}$
T_{stg}	Storage temperature		-55 to 175	$^\circ\text{C}$
R_{th-a}	Thermal resistance	Junction to ambient	20	$^\circ\text{C/W}$
		Junction to case	1.2	$^\circ\text{C/W}$

Note. Above parameters are guaranteed independently.

ELECTRICAL CHARACTERISTICS ($T_C = 25^\circ\text{C}$ unless otherwise specified)

Symbol	Parameter	Test conditions	Limits			Unit
			Min	Typ	Max	
$V_{(BR)EBO}$	Emitter to base breakdown voltage	$I_E = 10\text{mA}$, $I_C = 0$	5			V
$V_{(BR)CB0}$	Collector to base breakdown voltage	$I_C = 20\text{mA}$, $I_E = 0$	50			V
$V_{(BR)CE0}$	Collector to emitter breakdown voltage	$I_C = 0.1\text{A}$, $R_{BE} = \infty$	20			V
I_{CB0}	Collector cutoff current	$V_{CB} = 25\text{V}$, $I_E = 0$			5	mA
I_{EB0}	Emitter cutoff current	$V_{EB} = 2\text{V}$, $I_C = 0$			4	mA
h_{FE}	DC forward current gain*	$V_{CE} = 10\text{V}$, $I_C = 0.1\text{A}$	10	50	180	—
P_O	Output power	$V_{CC} = 13.5\text{V}$, $P_{in} = 4\text{W}$, $f = 30\text{MHz}$	75	85		W
η_C	Collector efficiency		55	65		%

Note. *Pulse test, $P_W = 150\mu\text{s}$, duty=5%.

Above parameters, ratings, limits and conditions are subject to change.

TEST CIRCUIT

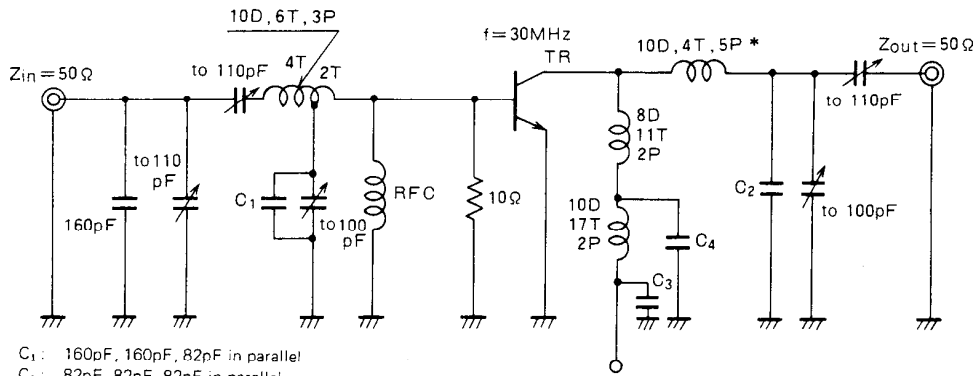

- C_1 : 160pF, 160pF, 82pF in parallel
 C_2 : 82pF, 82pF, 82pF in parallel
 C_3 : 100pF, 4700pF, 4700pF, 0.22 μ F, 0.22 μ F, 33 μ F, 330 μ F in parallel
 C_4 : 100pF, 220pF, 4700pF, 0.1 μ F, 330 μ F in parallel
 RFC: 1mm ϕ enameled wire 27T.
 Notes: All coils are made from 1.5mm ϕ silver plated copper wire but coil (sign *) is made from 2.3mm ϕ
 D: Inner diameter of coil P: Pitch of coil
 T: Turn number of coil Dimension in milli-meter

TYPICAL PERFORMANCE DATA

COLLECTOR DISSIPATION VS. AMBIENT TEMPERATURE

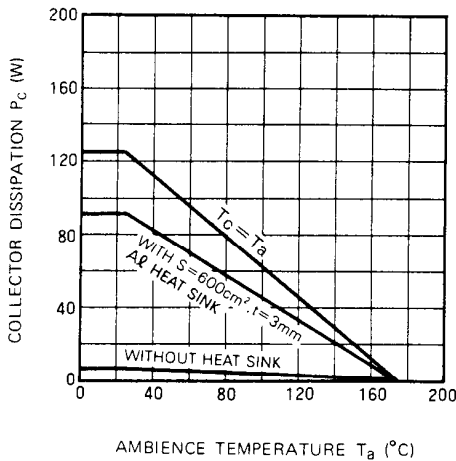

COLLECTOR CURRENT VS. COLLECTOR TO EMITTER VOLTAGE

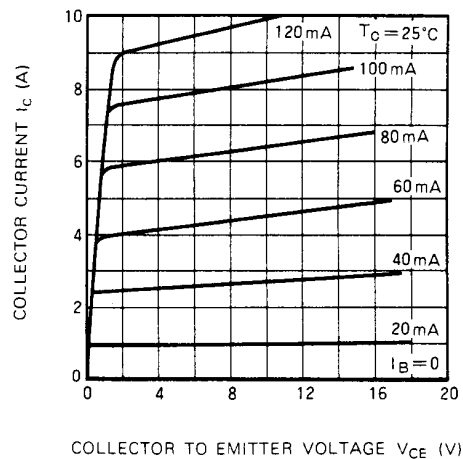

COLLECTOR TO EMITTER BREAKDOWN VOLTAGE VS. BASE TO EMITTER RESISTANCE

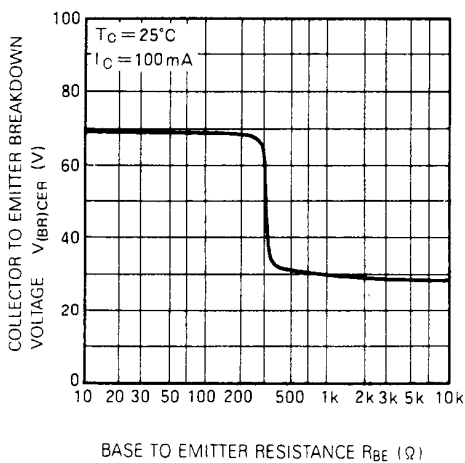

DC CURRENT GAIN VS. COLLECTOR CURRENT

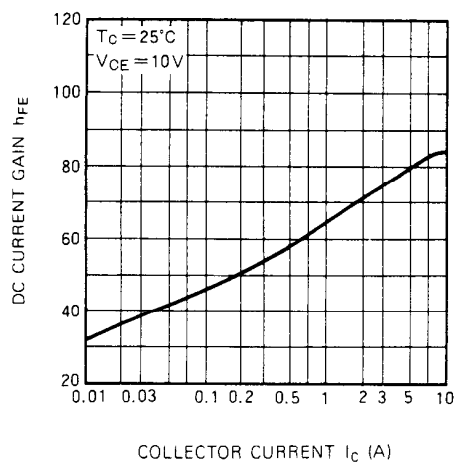

NPN EPITAXIAL PLANAR TYPE

COLLECTOR OUTPUT CAPACITANCE VS. COLLECTOR TO BASE VOLTAGE

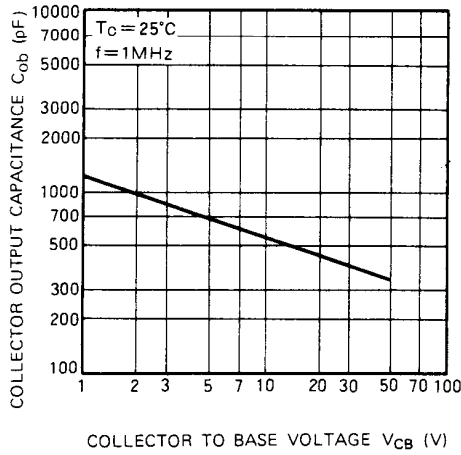

OUTPUT POWER, COLLECTOR EFFICIENCY VS. INPUT POWER

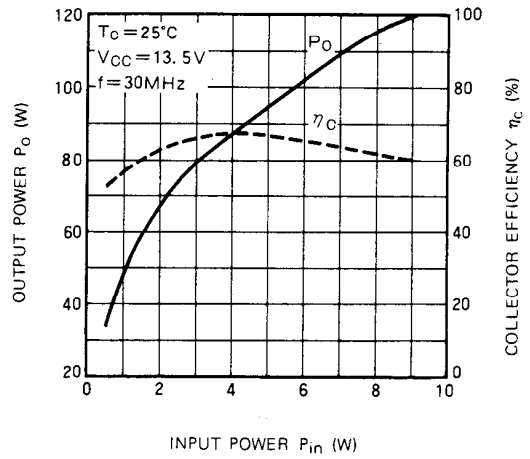

OUTPUT POWER VS. COLLECTOR SUPPLY VOLTAGE

