

Photosensor amplifier C2719

Current-to-voltage conversion amplifier for amplifying weak photocurrent with low noise



C2719 is a current-to-voltage conversion amplifier used to amplify weak photocurrent from a photodiode with very low noise. Three ranges of photocurrent detection sensitivity level (H, M, L) are selectable to match the input signal. A 10-turn potentiometer is used to zero the amplifier level so fine adjustments are possible with high resolution.

C2719 operates on the built-in dry batteries so it can be easily used anywhere. An external power input connector is also provided at the rear panel for a long, continuous operation or for use as part of a measurement system. In such applications, use the dedicated plug to connect to a stabilized DC power supply.

C2719 was developed specifically for use with Si photodiodes, but it can be used to detect photocurrent from phototubes.

Features

- Three sensitivity ranges
H: 10^9 V/A
M: 10^7 V/A
L: 10^5 V/A
- Zero adjustment with high resolution
- Operates on either dry batteries or external power supply
- Compact and lightweight

Applications

- Precision photometry
- Laser monitors
- Optical power meters
- Colorimeters
- Low signal current preamplifiers

General ratings (Ta=25 °C)

Parameter	Condition	Min.	Typ.	Max.	Unit
Output voltage amplitude	RL=2 kΩ	±5 (±10)	-	-	V
Offset drift		-	-	±0.1	mV/hr
Offset temperature characteristic		-	-	±25	μV/°C
Input voltage		-	-	±100	V
Recommended input capacitance		-	-	2×10^{-9}	F
Supply voltage *1		-	±9	-	V
External power supply		±6	-	±15	V
Battery lifetime	RL>10 kΩ	200	-	-	hr
Weight	Including batteries	-	420	-	g

Value in parentheses is measured when external power supply is used.

*1: Batteries: 006 P (9 V) × 2 pieces

Electrical and optical characteristics (Ta=25 °C)

Parameter	Internal batteries (Vs=±9 V)			External power supply (Vs=±15 V)			Unit
	H	M	L	H	M	L	
Conversion impedance	10^9	10^7	10^5	10^9	10^7	10^5	V/A
Input current range	to $\pm 5 \times 10^{-9}$	to $\pm 5 \times 10^{-7}$	to $\pm 5 \times 10^{-5}$	to $\pm 10 \times 10^{-9}$	to $\pm 10 \times 10^{-7}$	to $\pm 10 \times 10^{-5}$	A
Frequency bandwidth	DC to 16	DC to 1600	DC to 1600	DC to 16	DC to 1600	DC to 1600	Hz
Output noise *2 (all bandwidth)	0.2	0.2	0.2	0.2	0.2	0.2	mVp-p
	0.02	0.02	0.02	0.02	0.02	0.02	mVrms
Equivalent noise input current	2×10^{-14}	2×10^{-12}	2×10^{-10}	2×10^{-14}	2×10^{-12}	2×10^{-10}	A

*2: Measured with a 1.6 kHz lowpass filter added to the output of C2719.

■ Equivalent circuit

Figure 1 Equivalent circuit (when photodiode cathode is grounded)

<Amplifier circuit>

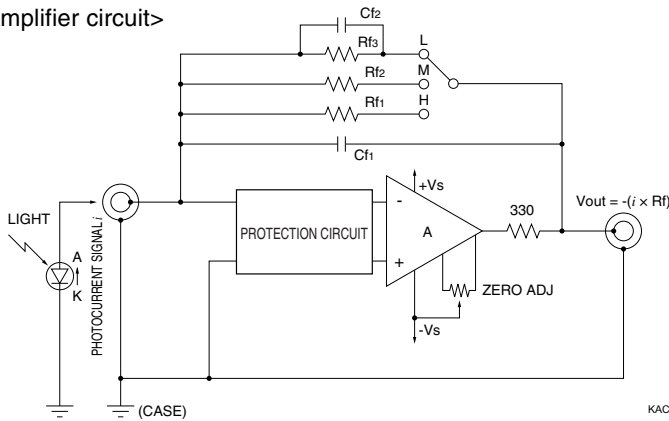

<Power supply circuit>

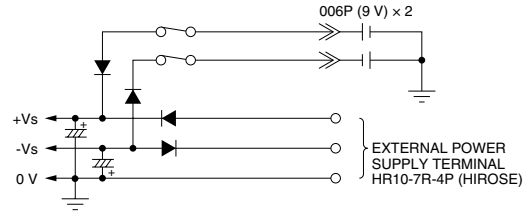

In the equivalent circuit diagram (Figure 1), the photocurrent signal i is connected to the input terminal of the negative feedback amplifier A. The input resistance of A is designed to be much larger than feedback resistance R_f , so all of i is flows through R_f . The result is that the output voltage of A is converted to $-i \times R_f$ (V), the reverse phase of i . R_f is switched to the High, Medium and Low ranges by the conversion impedance, with Medium being 1/100 of High and Low being 1/10000 of High.

Feedback capacitance C_f is 10 pF (1 nF + 10 pF at Low range) to prevent the circuit from becoming unstable at high frequencies. In this case, the cut-off frequency is calculated as follows:

$$f = \frac{1}{2\pi C_f R_f} \text{ (Hz)}$$

At this frequency, the output voltage is 0.7 times that at the low frequency.

■ Pulsed light measurement

● Output response waveform

If the photodiode terminal capacitance is approximately 2 nF or more, ringing may appear in the output waveform of C2719 when pulsed light is detected, resulting in inaccurate measurements. In this case, use a photodiode with a smaller terminal capacitance, or add a reverse voltage to the photodiode to reduce the terminal capacitance.

Figures 2 (a) and (b) show pulse response waveforms when used with S2281 photodiode which is designed to easily connect to C2719. The terminal capacitance of S2281 is 1.28 nF.

● Frequency response

Figure 3 shows the frequency response characteristics when used with S2281. As stated above, if the photodiode terminal capacitance is too large, a noticeable peak is formed in the frequency characteristics. This situation is shown in Figure 4. A frequency at which this kind of peak exists equals the reciprocal of the ringing cycle generated in the pulse response output waveform.

● S/N

As explained above, when the terminal capacitance of a photodiode is too large, peaking exists in the noise characteristics even when there is no light input, making it impossible to obtain an accurate S/N during light measurement.

Figure 5 shows the frequency characteristics of the signal and noise when S2281 is used. Here, peaking cannot be observed.

Figure 2 Output response waveform (S2281 + E2573)

(a) H range

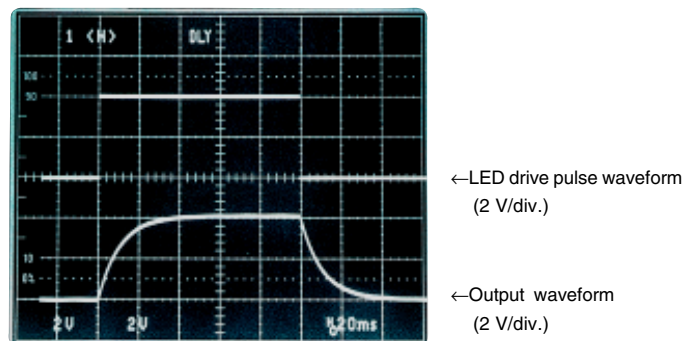

(b) L, M range

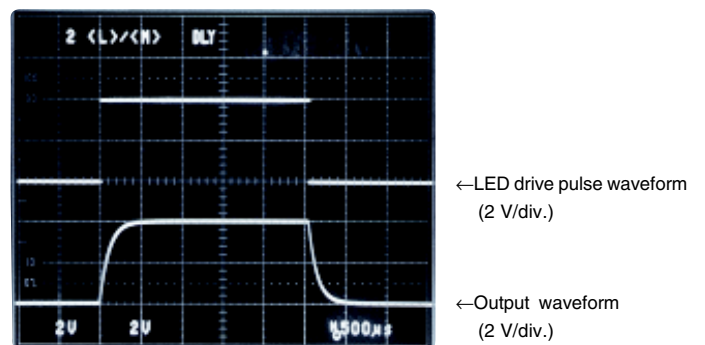

Figure 3 Frequency response (S2281 + E2573)

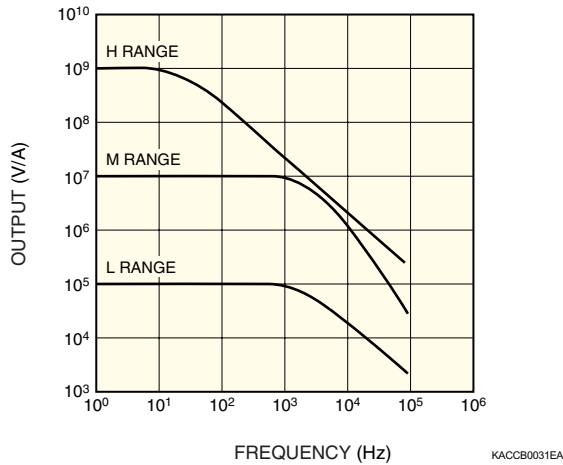

Figure 4 Gain peaking

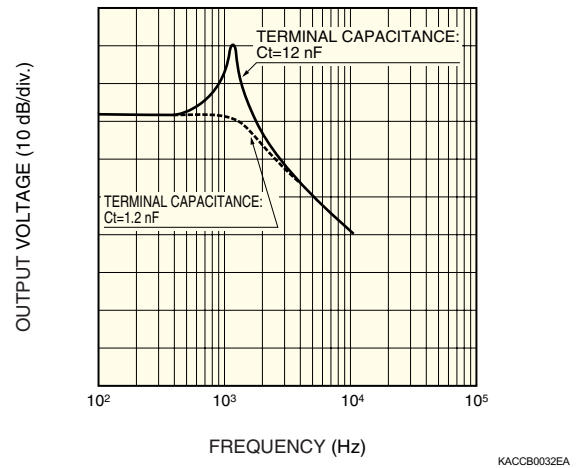

Figure 5 Frequency response of output signal and noise (S2281 + E2573)
[Light source: Directly modulated laser diode (DC biased)]

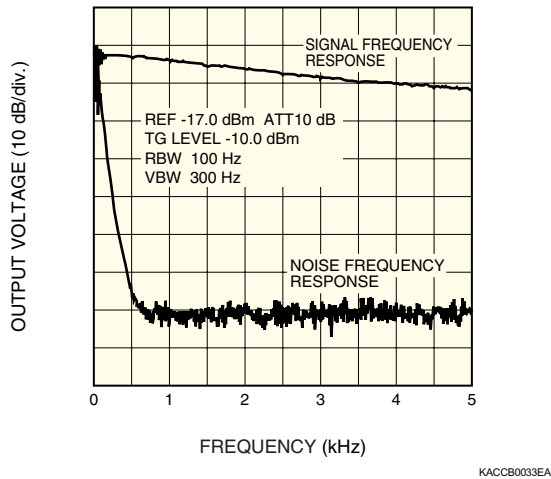
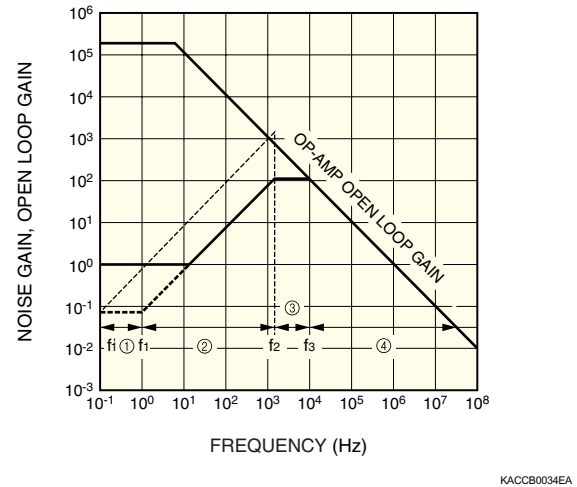

Figure 6 Schematic pursuit of gain peaking



■ Selecting photodiodes

As described previously, stable measurement may become impossible depending on the photodiode type. The diagrams are used here to explain how to select a correct photodiode which will not generate gain peaking when used with C2719.

Figure 6 shows an example in which a photodiode with a terminal capacitance C_t of 1.28 nF and a shunt resistance*2 R_{sh} of 130 M Ω (See note below). In the low-frequency range ①, the op-amp noise gain of C2719 is determined only by the ratio between R_{sh} and the feedback resistance R_f of C2719. Starting from frequency f_1 at $1/\omega C_t > R_{sh}$, the frequency increase is accompanied by an increase in gain over the interval indicated by ②. Next, as the frequency increases from f_2 at $1/\omega C_f > R_f$, the circuit noise gain is determined by the ratio of C_t to C_f , during the interval indicated by ③. Then, in the range covered by interval ④, the noise gain decreases, with a slope identical to that of the op-amp open loop gain starting from the point where it contacts frequency f_3 , which normally decreases at 6 dB/oct.

At this point, if C_t is multiplied by 10, f_1 moves to f_1' and the setting of the noise gain rise at ② exceeds the curve of the op-amp open loop gain. This causes area ③ to disappear. If this happens, C2719 can no longer maintain stable operation, and gain peaking appears. Consequently, it is necessary to make sure that area ③ always exists. With C2719, R_f and C_f are determined by the sensitivity range. Thus, whether gain peaking occurs or not depends on the C_t value of the photodiode, so selecting the appropriate photodiode is essential. Figure 7 shows what happens to each of the sensitivity ranges of C2719 when used with S2281.

*2: Shunt resistance $R_{sh} = \frac{10 \text{ mV}}{I_D (V_R = 10 \text{ mV})}$

Figure 7 Example of ranges

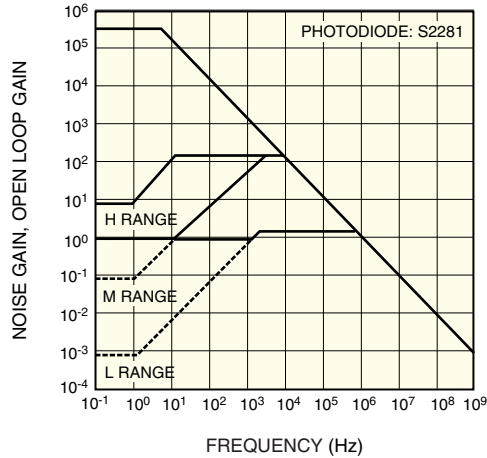

KACCB0035EA

■ Operation example

Figure 8 Typical application using S2281 photodiode

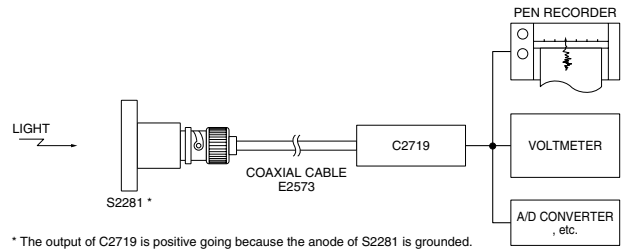

* The output of C2719 is positive going because the anode of S2281 is grounded.

KACCC0032EB

Figure 9 Typical application using an ordinary photodiode

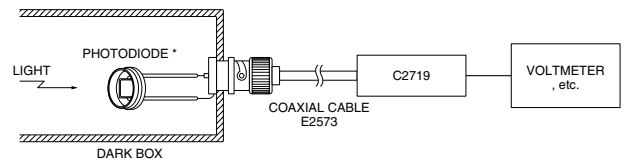

* The output of C2719 is negative going when the photodiode cathode is grounded, and is positive going when the anode is grounded.

KACCC0033EB

Figure 10 Typical application using a phototube

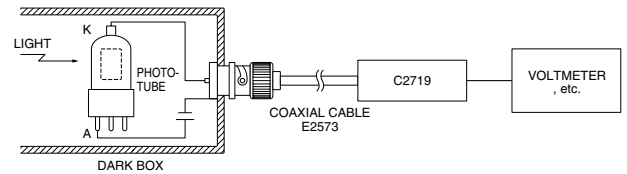

KACCC0034EA

Figure 11 Dimensional outline (unit: mm)

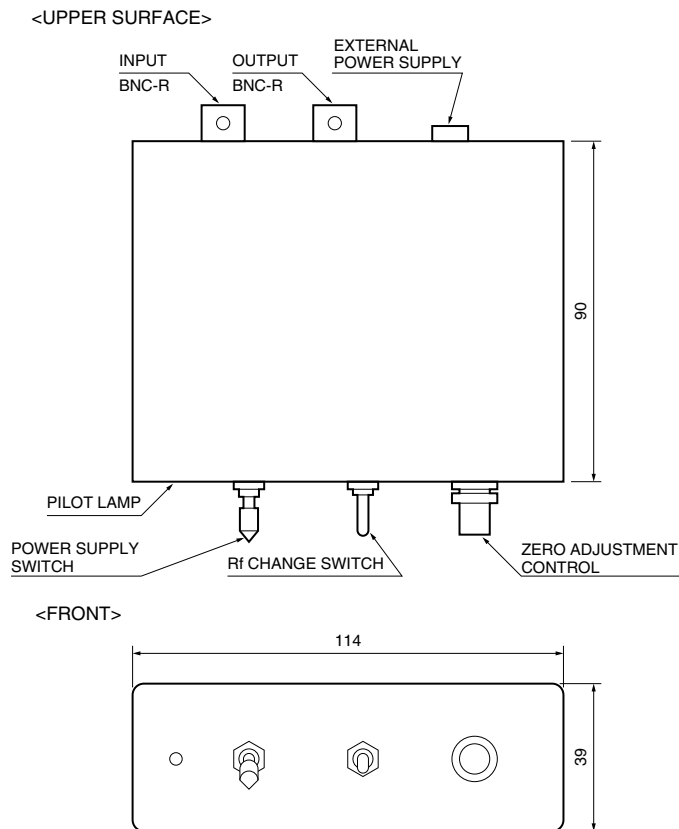

KACCA0022EA

■ Accessories

Plug for external power supply input

HR10-7P-4S (HIROSE)

Lead: AWG#24 (length: approx. 500 mm)

Color: red (+Vs), blue (-Vs), black (GND)

■ Option

E2573

BNC-BNC coaxial cable

(coaxial cable: 1.5D-2V, cable length: 1 m)

■ Precaution for use

- When an external power supply is used for C2719, voltage is supplied regardless of whether the power switch of C2719 is on or off. Use the power switch of the external power supply to turn voltage on and off.
- There are photodiodes whose cathode is connected to the metal package. To connect the cathode of such a photodiode to C2719, be sure to hold the photodiode with insulator as shown in Figure 12. The signal current cannot be obtained if the photodiode package is grounded.

Figure 12 Connection to photodiode whose cathode is connected to metal package

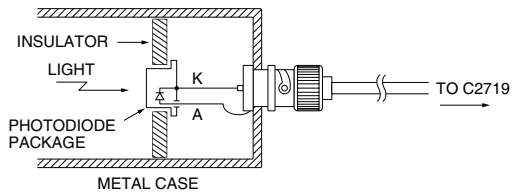

KACCC0035EA

- Avoid using C2719 in locations subjected to excessive vibrations. If unavoidable, use a low-noise coaxial cable as the signal input cable.
- In low-light-level detection circuits, insulation resistance of the circuit board and other insulation materials can affect measurement accuracy. Avoid humidity and soiling.
- Noise increases when the input capacitance becomes larger, so keep the input coaxial cable as short as possible.
- Remove the batteries when C2719 is not to be used for a long period.
- An input protection circuit is incorporated, but even so, do not apply more than ± 100 V.
- For external power supply, use a regulated DC power supply with a ripple of less than 3 mVp-p. Make sure that the supply voltage does not exceed ± 15 V even momentarily. Avoid using a switching power supply, as this can cause noise problems during measurement.

Photosensor amplifier C6386

Hamamatsu also provides C6386 high-speed photosensor amplifier that incorporates a photodiode at the installation port of the optical fiber (1 meter long).

Features

- Easy handling
Built-in photodiode allows easy detection of light just by connecting to a voltmeter.
- Optical fiber light input
Measures light at a narrow detection point. Separating the amplifier from the detection point allows measurement in unusual environments and improves S/N.
- High-speed response
- Three sensitivity ranges

Range	Photocurrent detection sensitivity	Cut-off frequency
H	10^5 V/A	1 MHz
M	10^4 V/A	3 MHz
L	10^3 V/A	10 MHz



Si photodiode S2281 series

Si photodiode with BNC connector



S2281 series photodiodes are sealed in a metal package with a BNC connector and designed to simply connect to C2719 photosensor amplifier (S2281-01 has a large terminal capacitance which may cause a gain peaking to occur when C2719 is used with the gain set to the "M" range.) Two different spectral response ranges are provided. The large active area makes S2281 series suitable for optical power meters. A variant type S9219 with a visual compensation filter is also available. Hamamatsu also provides E2573 BNC-BNC coaxial cable (length: 1 m) as an option.

General ratings

Parameter	S2281	S2281-01	S2281-04	Unit
Active area size	$\phi 11.3$	$\phi 11.3$	$\phi 7.98$	mm
Active area	100	100	50	mm ²
Package	Metal with BNC connector			-
Window material	Quartz glass			-

Absolute maximum ratings

Parameter	Symbol	S2281	S2281-01	S2281-04	Unit
Reverse voltage	VR Max.	5			V
Operating temperature	Topr	-10 to +60			°C
Storage temperature	Tstg	-20 to +70			°C

Electrical and optical characteristics (Ta=25 °C, unless otherwise noted)

Parameter	Symbol	Condition	S2281			S2281-01			S2281-04			Unit
			Min.	Typ.	Max.	Min.	Typ.	Max.	Min.	Typ.	Max.	
Spectral response range	λ		-	190 to 1100	-	-	190 to 1000	-	-	190 to 1100	-	nm
Peak sensitivity wavelength	λ_p		-	960	-	-	720	-	-	960	-	nm
Photo sensitivity	S	$\lambda=200$ nm	0.10	0.12	-	0.10	0.12	-	0.10	0.12	-	A/W
		$\lambda=\lambda_p$	-	0.5	-	-	0.36	-	-	0.5	-	
Short circuit current	Isc	100 lx	64	80	-	32	40	-	32	40	-	μ A
Dark current	ID	VR=10 mV	-	50	500	-	6	300	-	50	500	pA
Shunt resistance	Rsh	VR=10 mV	20	200	-	30	1700	-	20	200	-	M Ω
Rise time	tr	VR=0 V RL=1 k Ω	-	3	-	-	7	-	-	3	-	μ s
Terminal capacitance	Ct	VR=0 V f=10 kHz	-	1300	-	-	3200	-	-	1300	-	pF
Noise equivalent power	NEP		-	2.0 $\times 10^{-14}$	-	-	8.6 $\times 10^{-15}$	-	-	1.8 $\times 10^{-14}$	-	W/Hz ^{1/2}

Spectral response

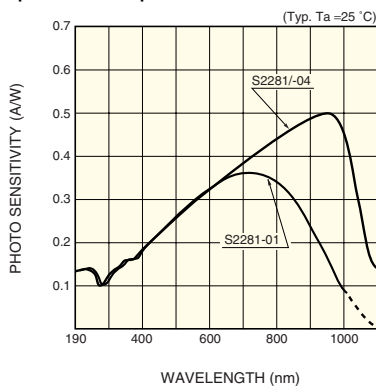

Dimensional outline (unit: mm)

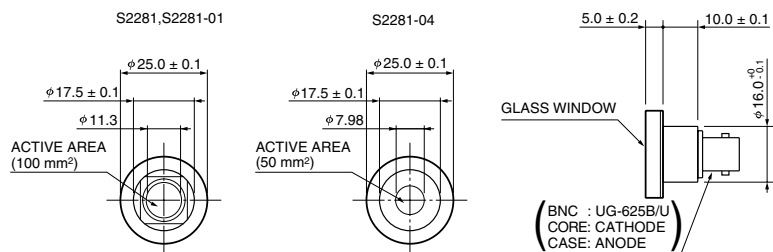

KSPDA0080EA

HAMAMATSU

Information furnished by HAMAMATSU is believed to be reliable. However, no responsibility is assumed for possible inaccuracies or omissions. Specifications are subject to change without notice. No patent rights are granted to any of the circuits described herein. ©2003 Hamamatsu Photonics K.K.

HAMAMATSU PHOTONICS K.K., Solid State Division

1126-1 Ichino-cho, Hamamatsu City, 435-8558 Japan, Telephone: (81) 053-434-3311, Fax: (81) 053-434-5184, <http://www.hamamatsu.com>

U.S.A.: Hamamatsu Corporation: 360 Foothill Road, P.O.Box 6910, Bridgewater, N.J. 08807-0910, U.S.A., Telephone: (1) 908-231-0960, Fax: (1) 908-231-1218

Germany: Hamamatsu Photonics Deutschland GmbH: Arzbergerstr. 10, D-82211 Herrsching am Ammersee, Germany, Telephone: (49) 08152-3750, Fax: (49) 08152-2658

France: Hamamatsu Photonics France S.A.R.L.: 8, Rue du Saule Trapu, Parc du Moulin de Massy, 91882 Massy Cedex, France, Telephone: 33-(1) 69 53 71 00, Fax: 33-(1) 69 53 71 10

United Kingdom: Hamamatsu Photonics UK Limited: 2 Howard Court, 10 Tewin Road, Welwyn Garden City, Hertfordshire AL7 1BW, United Kingdom, Telephone: (44) 1707-294888, Fax: (44) 1707-325777

North Europe: Hamamatsu Photonics Norden AB: Smidsvågen 12, SE-171 41 Solna, Sweden, Telephone: (46) 8-509-031-00, Fax: (46) 8-509-031-01

Italy: Hamamatsu Photonics Italia S.R.L.: Strada della Moia, 1/E, 20020 Arese, (Milano), Italy, Telephone: (39) 02-935-81-733, Fax: (39) 02-935-81-741

Cat. No. KACC1011E05
Feb. 2003 DN