

# C2M0025120D

Silicon Carbide Power MOSFET  
C2M™ MOSFET Technology  
N-Channel Enhancement Mode

## Features

- High Blocking Voltage with Low On-Resistance
- High Speed Switching with Low Capacitances
- Easy to Parallel and Simple to Drive
- Avalanche Ruggedness
- Resistant to Latch-Up
- Halogen Free, RoHS Compliant

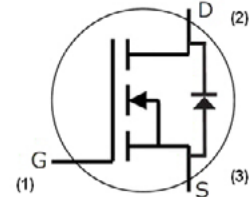

WolfSpeed, Inc. is in the process of rebranding its products and related materials pursuant to the entity name change from Cree, Inc. to WolfSpeed, Inc. During this transition period, products received may be marked with either the Cree name and/or logo or the WolfSpeed name and/or logo.

Ordering Part Number	Package	Marking
C2M0025120D	TO-247-3	C2M0025120

## Applications

- Solar inverters
- Switch Mode Power Supplies
- High Voltage DC/DC converters
- Battery Chargers
- Motor Drive
- Pulsed Power Applications

## Benefits

- Higher system efficiency
- Reduce cooling requirements
- Increase power density
- Increase system switching frequency

Parameter	Symbol	Value	Unit	Test Conditions	Note
Drain-Source Voltage	$V_{DS\ max}$	1200	V	$V_{GS} = 0\ V, I_D = 100\ \mu A$	
Gate-Source Voltage	$V_{GS\ max}$	-10/+25		Absolute maximum values	
Gate-Source Voltage	$V_{GS\ op}$	-5/+20		Recommended operational values	
Continuous Drain Current <sup>1</sup>	$I_D$	63	A	$V_{GS} = 20\ V, T_C = 25^\circ C$	Fig. 19 Note 1
		39		$V_{GS} = 20\ V, T_C = 100^\circ C$	
Pulsed Drain Current	$I_{D(pulsed)}$	250		Pulse width $t_p$ limited by $T_{j\ max}$	Fig. 22
Power Dissipation	$P_D$	378	W	$T_C = 25^\circ C, T_J = 150^\circ C$	Fig. 20
Operating Junction and Storage Temperature	$T_J, T_{stg}$	-55 to +150	°C		
Solder Temperature	$T_L$	260		According to JEDEC J-STD-020	
Mounting Torque	$M_D$	8.8	lbf-in	M3 or 6-32 Screw	

Note:

<sup>1</sup> Die limits are 90A (25°C) and 60A (100°C)

**Electrical Characteristics** ( $T_C = 25^\circ\text{C}$  unless otherwise specified)

Parameter	Symbol	Min.	Typ.	Max.	Unit	Test Conditions	Note
Drain-Source Breakdown Voltage	$V_{(BR)DSS}$	1200	—	—	V	$V_{GS} = 0\text{ V}, I_D = 100\ \mu\text{A}$	Fig. 11
Gate Threshold Voltage	$V_{GS(th)}$	2.0	2.6	4		$V_{DS} = V_{GS}, I_D = 15\ \text{mA}$	
		—	2.3	—		$V_{DS} = V_{GS}, I_D = 25\ \text{mA}, T_J = 150^\circ\text{C}$	
Zero Gate Voltage Drain Current	$I_{DSS}$	—	2	100	$\mu\text{A}$	$V_{DS} = 1200\ \text{V}, V_{GS} = 0\ \text{V}$	
Gate-Source Leakage Current	$I_{GSS}$	—	—	250	nA	$V_{GS} = 20\ \text{V}, V_{DS} = 0\ \text{V}$	
Drain-Source On-State Resistance	$R_{DS(on)}$	—	25	34	m $\Omega$	$V_{GS} = 20\ \text{V}, I_D = 50\ \text{A}$	Fig. 4, 5, 6
		—	41	—		$V_{GS} = 20\ \text{V}, I_D = 50\ \text{A}, T_J = 150^\circ\text{C}$	
Transconductance	$g_{fs}$	—	24.6	—	S	$V_{DS} = 20\ \text{V}, I_{DS} = 50\ \text{A}$	Fig. 7
			24			$V_{DS} = 20\ \text{V}, I_{DS} = 50\ \text{A}, T_J = 150^\circ\text{C}$	
Input Capacitance	$C_{iss}$	—	3140	—	pF	$V_{GS} = 0\ \text{V}, V_{DS} = 1000\ \text{V}$ $f = 1\ \text{MHz}$ $V_{AC} = 25\ \text{mV}$	Fig. 17, 18
Output Capacitance	$C_{oss}$	—	224	—			
Reverse Transfer Capacitance	$C_{rss}$	—	9	—			
$C_{oss}$ Stored Energy	$E_{oss}$	—	128	—			
Turn-On Switching Energy (Body Diode)	$E_{on}$	—	2.18	—	mJ	$V_{DS} = 800\ \text{V}, V_{GS} = -5\ \text{V}/+20\ \text{V}, I_D = 50\ \text{A},$ $R_{G(ext)} = 2.5\ \Omega, L = 99\ \mu\text{H}$ FWD = Internal Body Diode of MOSFET	Fig. 26
Turn Off Switching Energy ((Body Diode)	$E_{off}$	—	0.68	—			
Turn-On Switching Energy (External SiC Diode)	$E_{on}$	—	1.14	—			
Turn Off Switching Energy (External SiC Diode)	$E_{off}$	—	0.8	—			
Turn-On Delay Time	$t_{d(on)}$	—	15	—	ns	$V_{DD} = 800\ \text{V}, V_{GS} = -5\ \text{V}/20\ \text{V}, I_D = 50\ \text{A},$ $R_{G(ext)} = 2.5\ \Omega,$ Inductive Load Timing relative to $V_{DS}$ Per IEC60747-8-4 pg 83	Fig. 27
Rise Time	$t_r$	—	58	—			
Turn-Off Delay Time	$t_{d(off)}$	—	33	—			
Fall Time	$t_f$	—	17	—			
Internal Gate Resistance	$R_{G(int)}$	—	1.0	—	$\Omega$	$f = 1\ \text{MHz}, V_{AC} = 25\ \text{mV},$ ESR of $C_{iss}$	
Gate to Source Charge	$Q_{gs}$	—	46	—	nC	$V_{DS} = 800\ \text{V}, V_{GS} = -5\ \text{V}/20\ \text{V}$ $I_D = 50\ \text{A}$ Per IEC60747-8-4 pg 21	Fig. 12
Gate to Drain Charge	$Q_{gd}$	—	71.5	—			
Total Gate Charge	$Q_g$	—	194	—			



## Reverse Diode Characteristics

Parameter	Symbol	Typ.	Max.	Unit	Test Conditions	Notes
Diode Forward Voltage	$V_{SD}$	4.1	—	V	$V_{GS} = -5\text{ V}, I_{SD} = 25\text{ A}$	Fig. 8, 9, 10
		3.5	—		$V_{GS} = -5\text{ V}, I_{SD} = 25\text{ A}, T_J = 150^\circ\text{C}$	
Continuous Diode Forward Current <sup>2</sup>	$I_S$	—	63		$V_{GS} = -5\text{ V}, T_C = 25^\circ\text{C}$	Note 2
Diode Pulse Current	$I_{S,pulse}$	—	250		$V_{GS} = -5\text{ V}$ , pulse width $t_P$ limited by $T_{J,max}$	
Reverse Recovery Time <sup>2</sup>	$t_{rr}$	33	—	ns	$V_{GS} = -5\text{ V}, I_{SD} = 50\text{ A}, T_J = 25^\circ\text{C}$ $V_R = 800\text{ V}$ $di_f/dt = 2180\text{ A}/\mu\text{s}$	Note 2
Reverse Recovery Charge <sup>2</sup>	$Q_{rr}$	487	—	nC		
Peak Reverse Recovery Current <sup>2</sup>	$I_{RRM}$	24	—	A		
Reverse Recovery Time <sup>2</sup>	$t_{rr}$	67	—	ns	$V_{GS} = -5\text{ V}, I_{SD} = 50\text{ A}, T_J = 25^\circ\text{C}$ $V_R = 800\text{ V}$ $di_f/dt = 1320\text{ A}/\mu\text{s}$	Note 2
Reverse Recovery Charge <sup>2</sup>	$Q_{rr}$	386	—	nC		
Peak Reverse Recovery Current <sup>2</sup>	$I_{RRM}$	15	—	A		

Note:

<sup>2</sup>When using SiC Body Diode the maximum recommended  $V_{GS} = -5\text{V}$

## Thermal Characteristics

Parameter	Symbol	Typ.	Max.	Unit	Test Conditions	Notes
Thermal Resistance from Junction to Case	$R_{\theta JC}$	0.24	0.33	$^\circ\text{C}/\text{W}$		Fig. 21
Thermal Resistance from Junction to Ambient	$R_{\theta JA}$		40			



Typical Performance

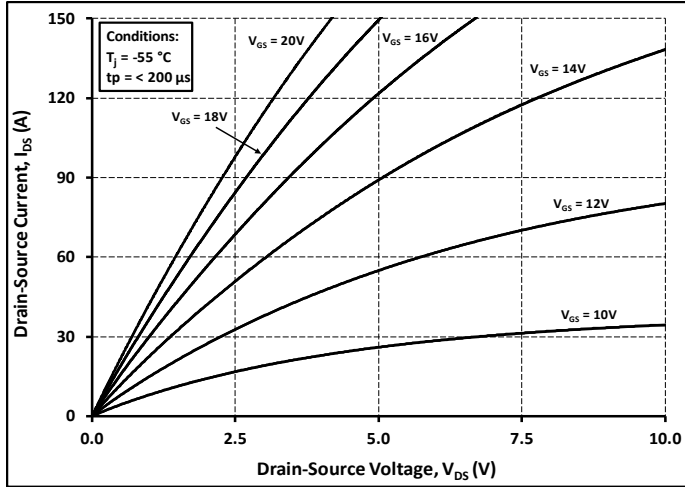

Figure 1. Output Characteristics  $T_j = -55^\circ\text{C}$

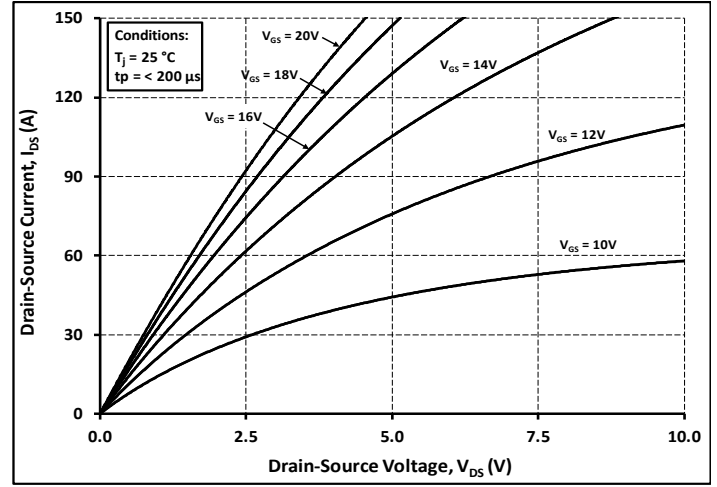

Figure 2. Output Characteristics  $T_j = 25^\circ\text{C}$

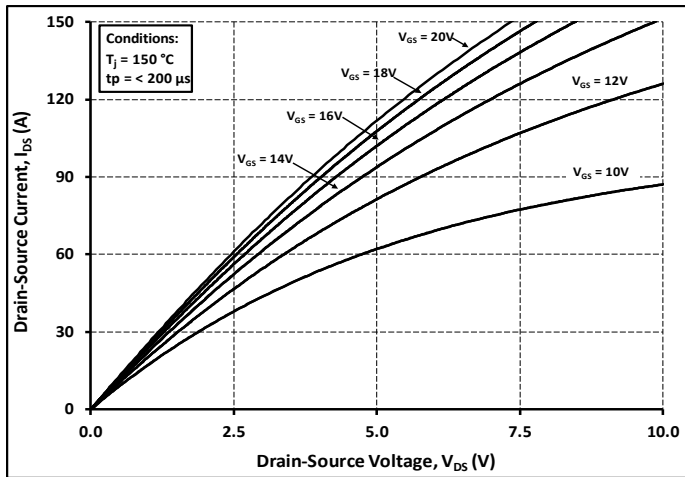

Figure 3. Output Characteristics  $T_j = 150^\circ\text{C}$

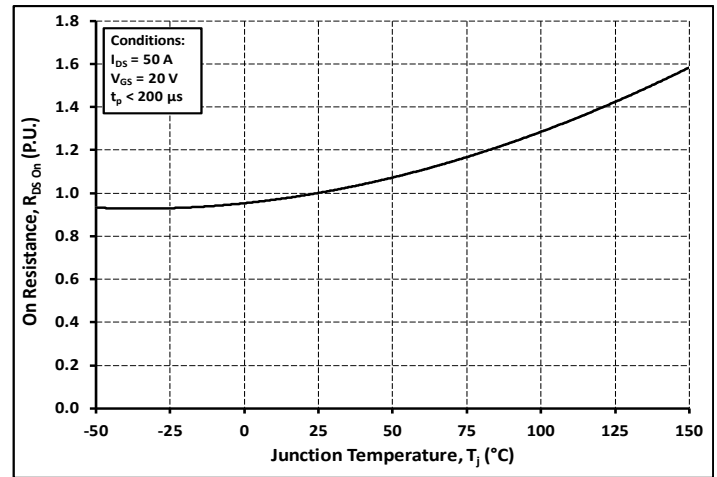

Figure 4. Normalized On-Resistance vs. Temperature

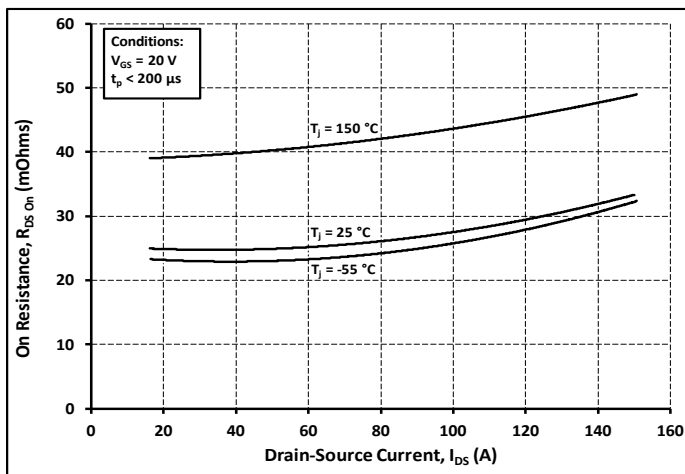

Figure 5. On-Resistance vs. Drain Current For Various Temperatures

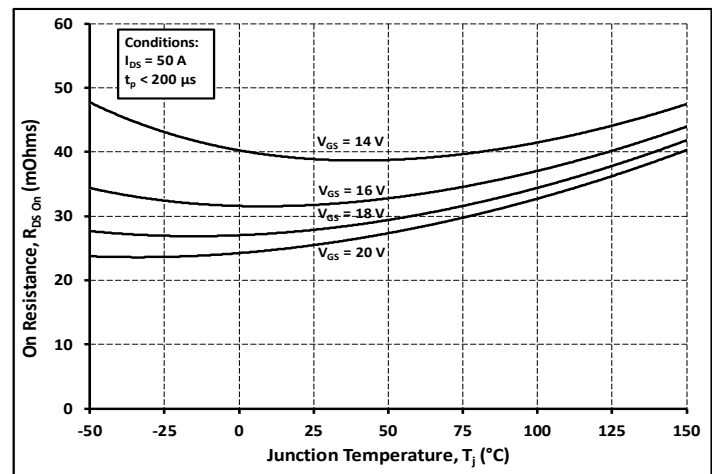

Figure 6. On-Resistance vs. Temperature For Various Gate Voltage



Typical Performance

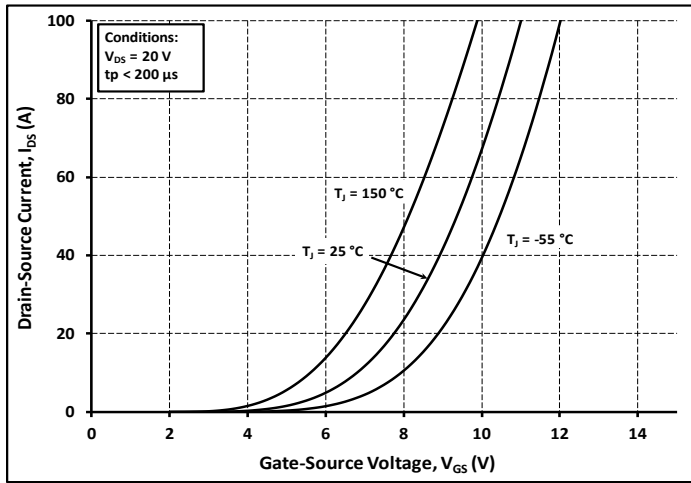

Figure 7. Transfer Characteristic for

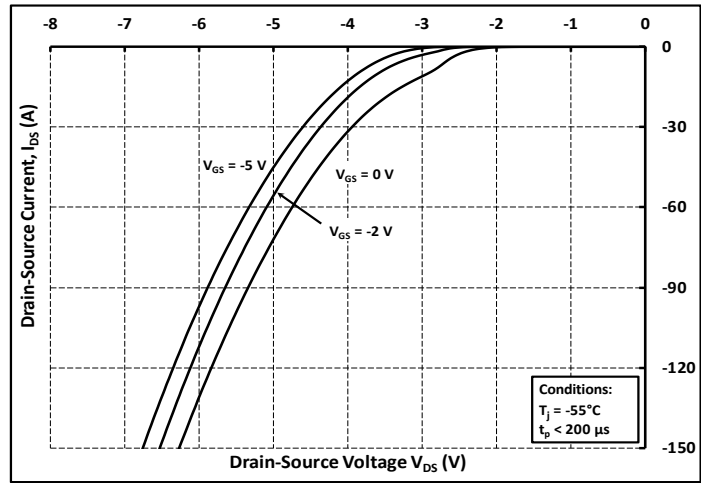

Figure 8. Body Diode Characteristic at -55°C

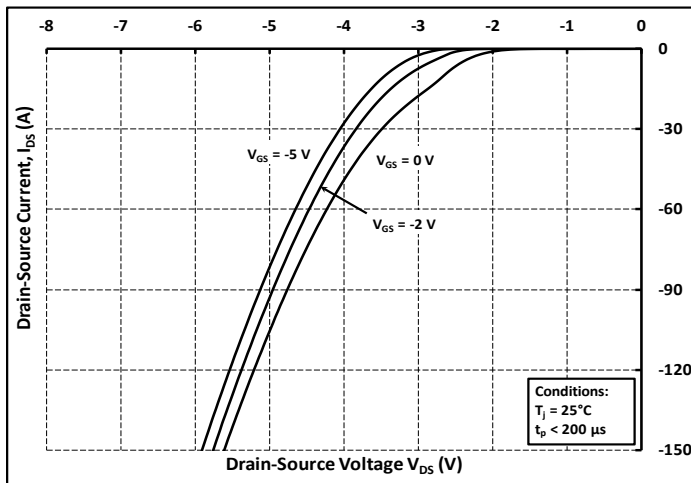

Figure 9. Body Diode Characteristic at 25°C

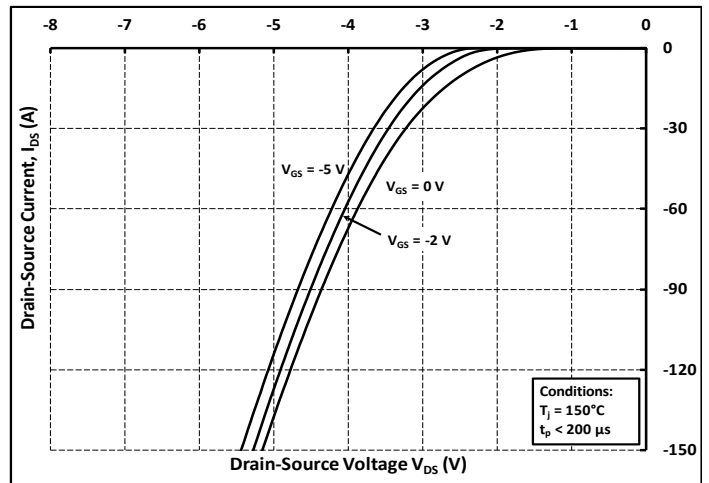

Figure 10. Body Diode Characteristic at 150°C

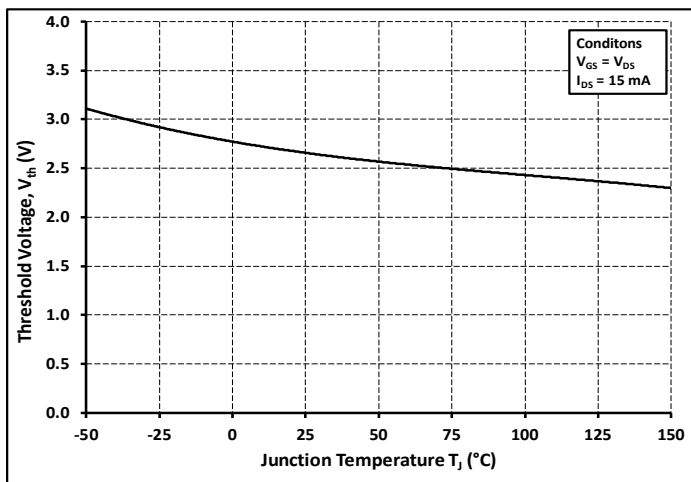

Figure 11. Threshold Voltage vs. Temperature

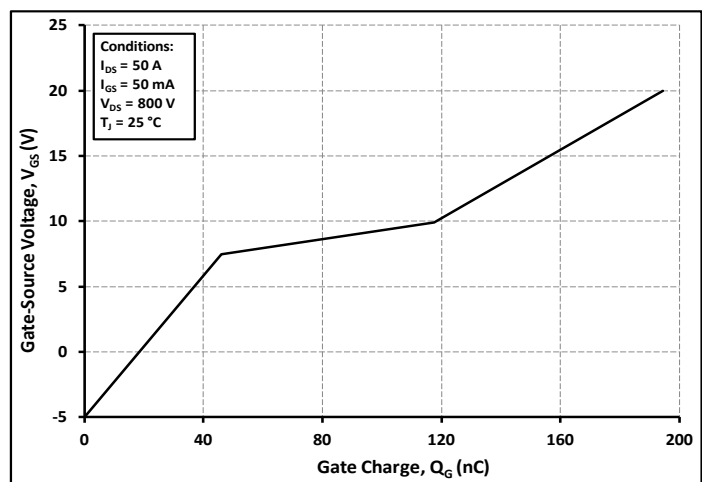

Figure 12. Gate Charge Characteristics



Typical Performance

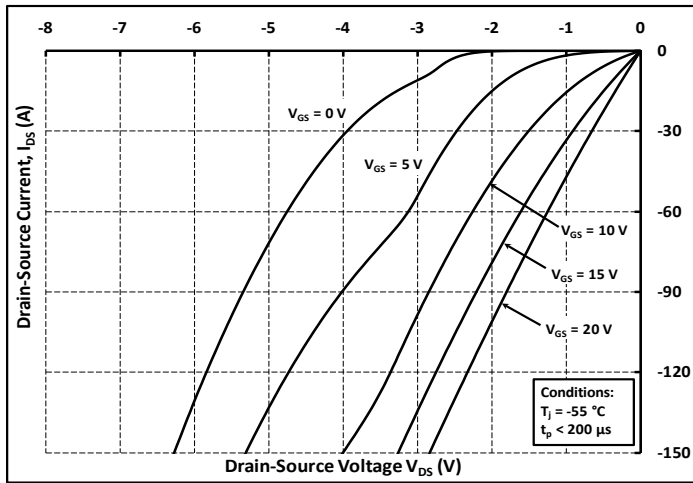

Figure 13. 3rd Quadrant Characteristic at  $-55^\circ\text{C}$

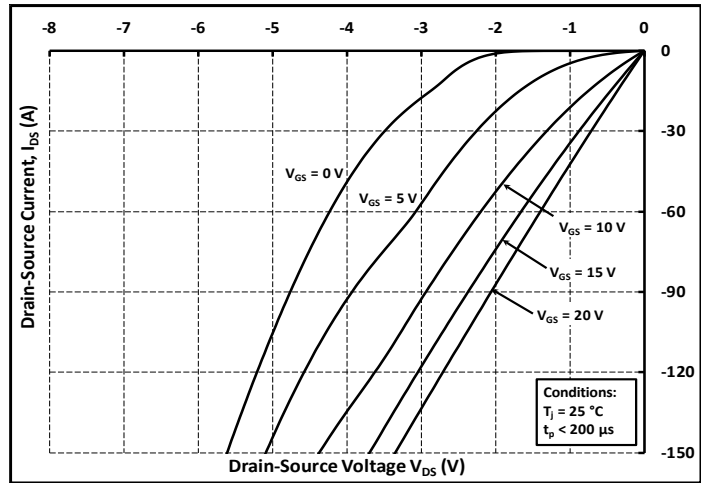

Figure 14. 3rd Quadrant Characteristic at  $25^\circ\text{C}$

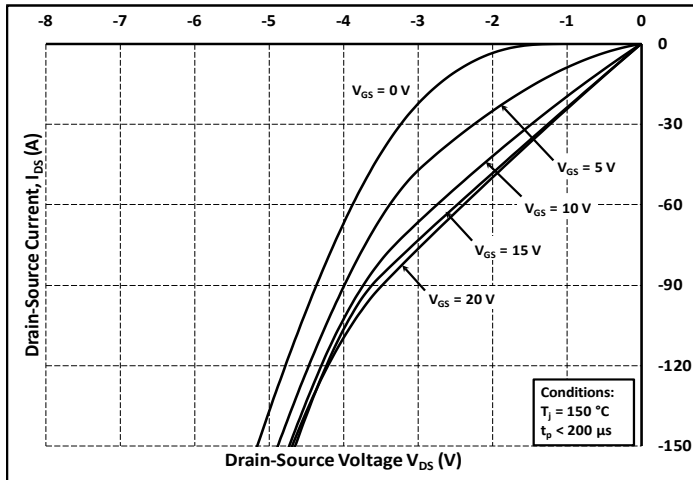

Figure 15. 3rd Quadrant Characteristic at  $150^\circ\text{C}$

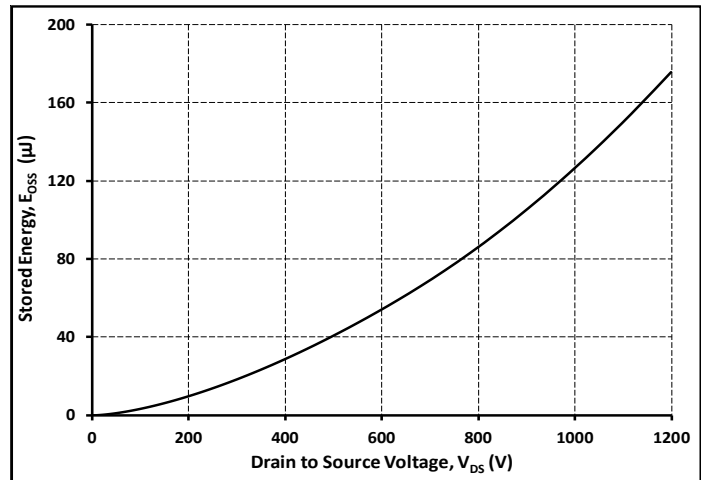

Figure 16. Output Capacitor Stored Energy

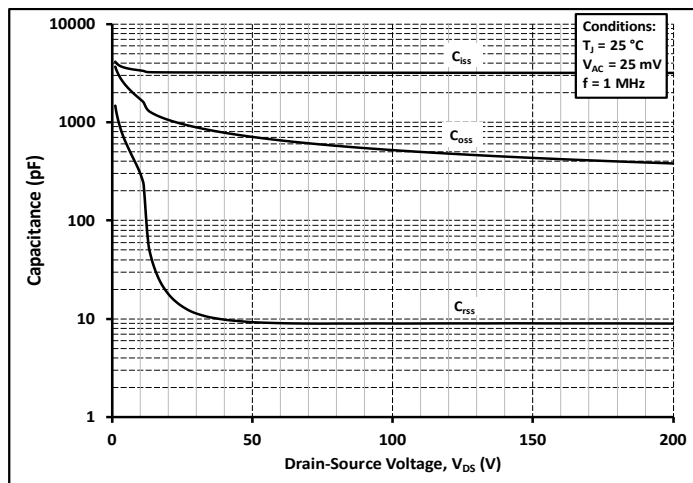

Figure 17. Capacitances vs. Drain-Source

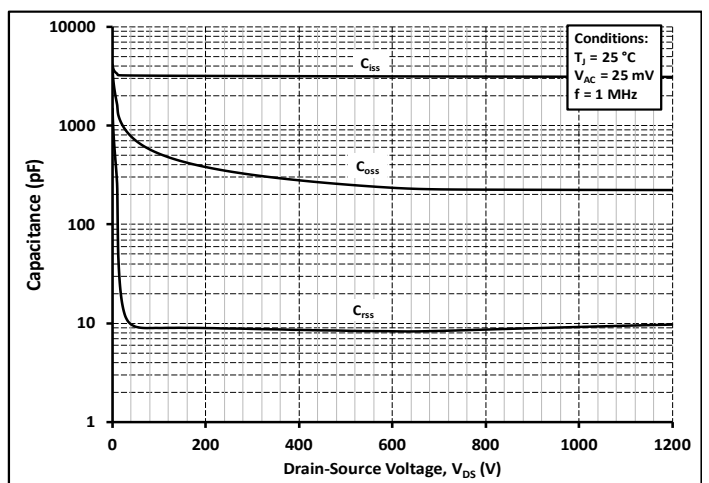

Figure 18. Capacitances vs. Drain-Source



Typical Performance

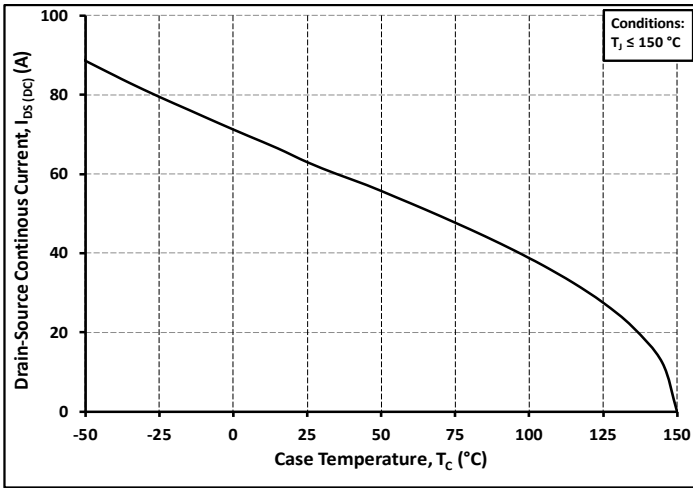

Figure 19. Continuous Drain Current Derating vs. Case Temperature

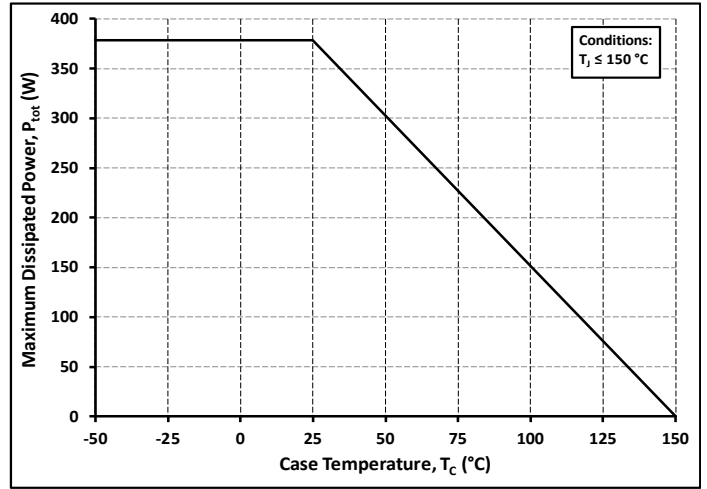

Figure 20. Maximum Power Dissipation Derating vs. Case Temperature

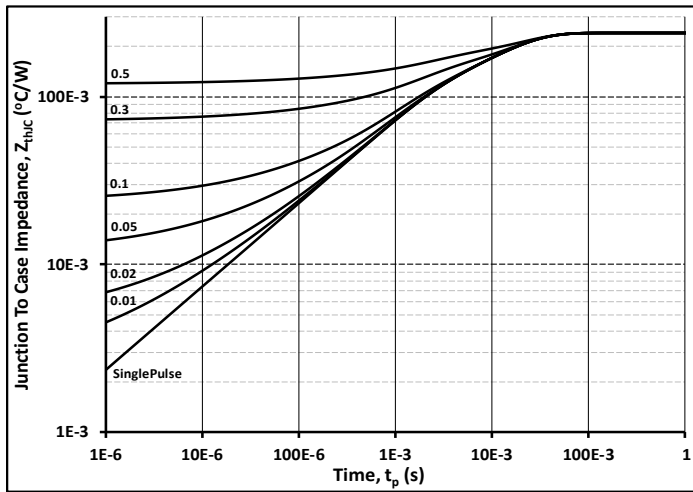

Figure 21. Transient Thermal Impedance

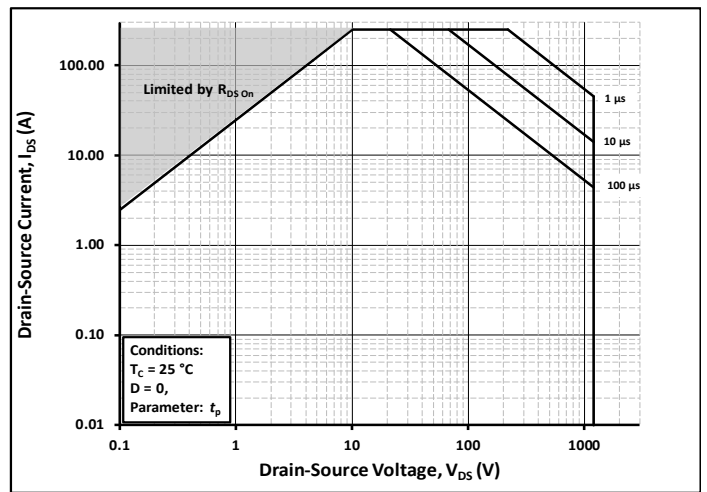

Figure 22. Safe Operating Area

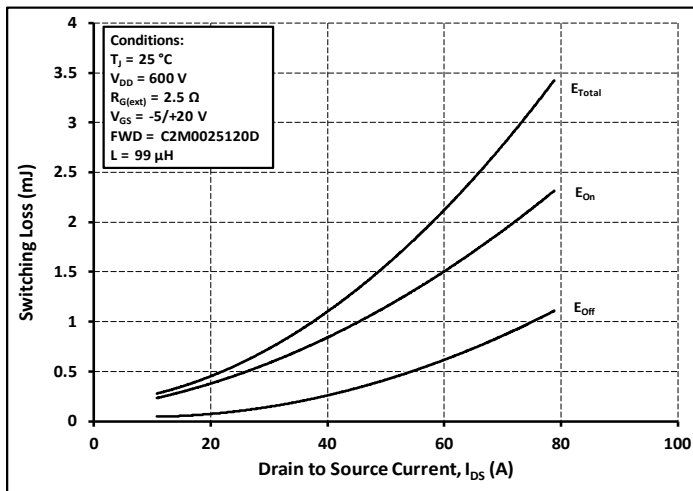

Figure 23. Clamped Inductive Switching Energy

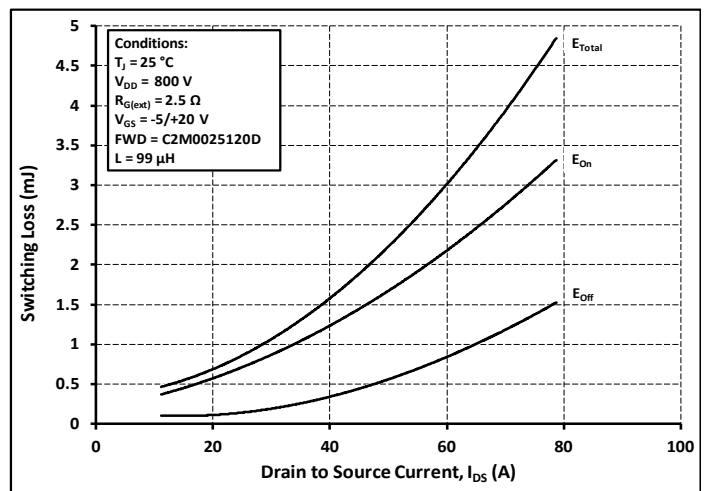

Figure 24. Clamped Inductive Switching Energy



Typical Performance

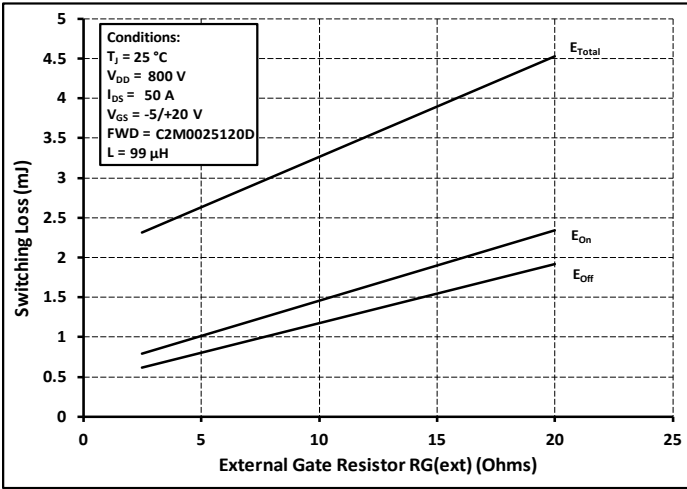

Figure 25. Clamped Inductive Switching Energy vs.  $R_{G(ext)}$

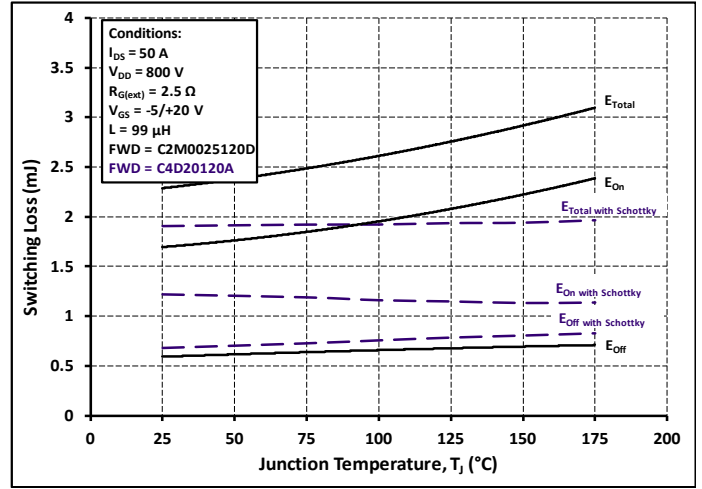

Figure 26. Clamped Inductive Switching Energy

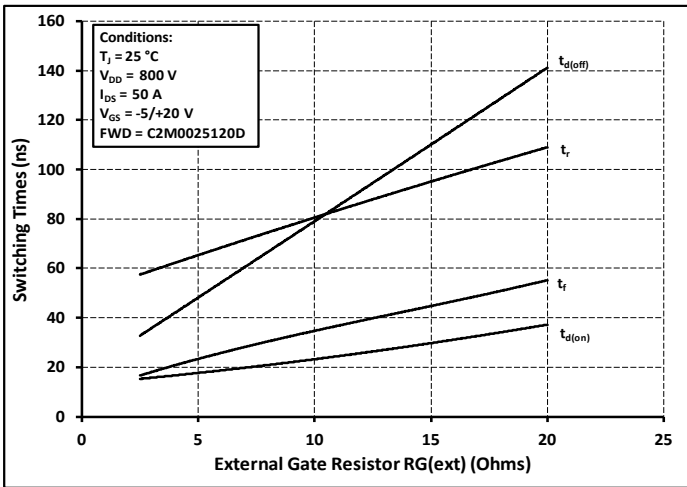

Figure 27. Switching Times vs.  $R_{G(ext)}$

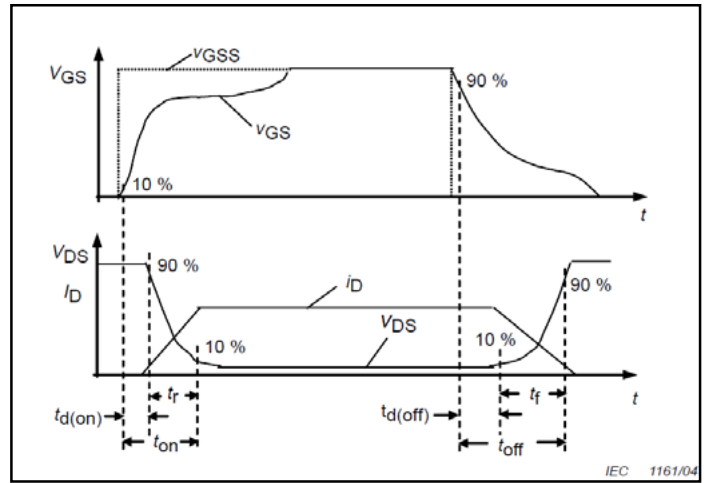
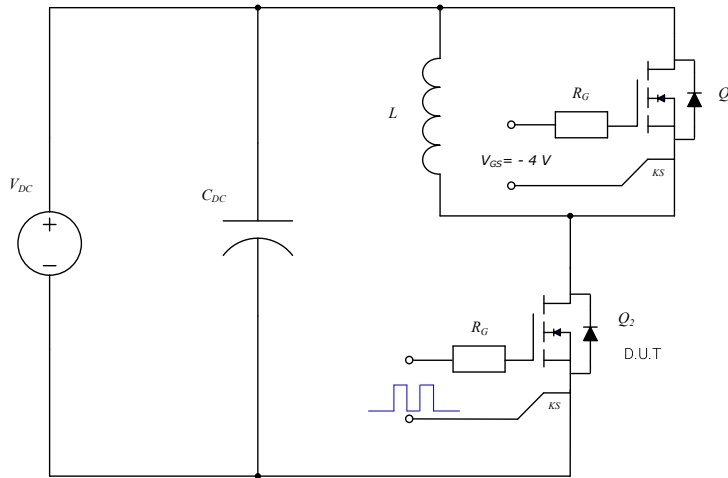

Figure 28. Switching Times Definition





**Test Circuit Schematic<sup>1</sup>**



**Figure 29. Clamped Inductive Switching**

Note:

<sup>1</sup> Turn-off and Turn-on switching energy and timing values measured using SiC MOSFET Body Diode as shown above.

**ESD Rating**

ESD Test	Resulting Classification
ESD-HBM	3A (4000V - 8000V)

Package Dimensions - TO-247-4L

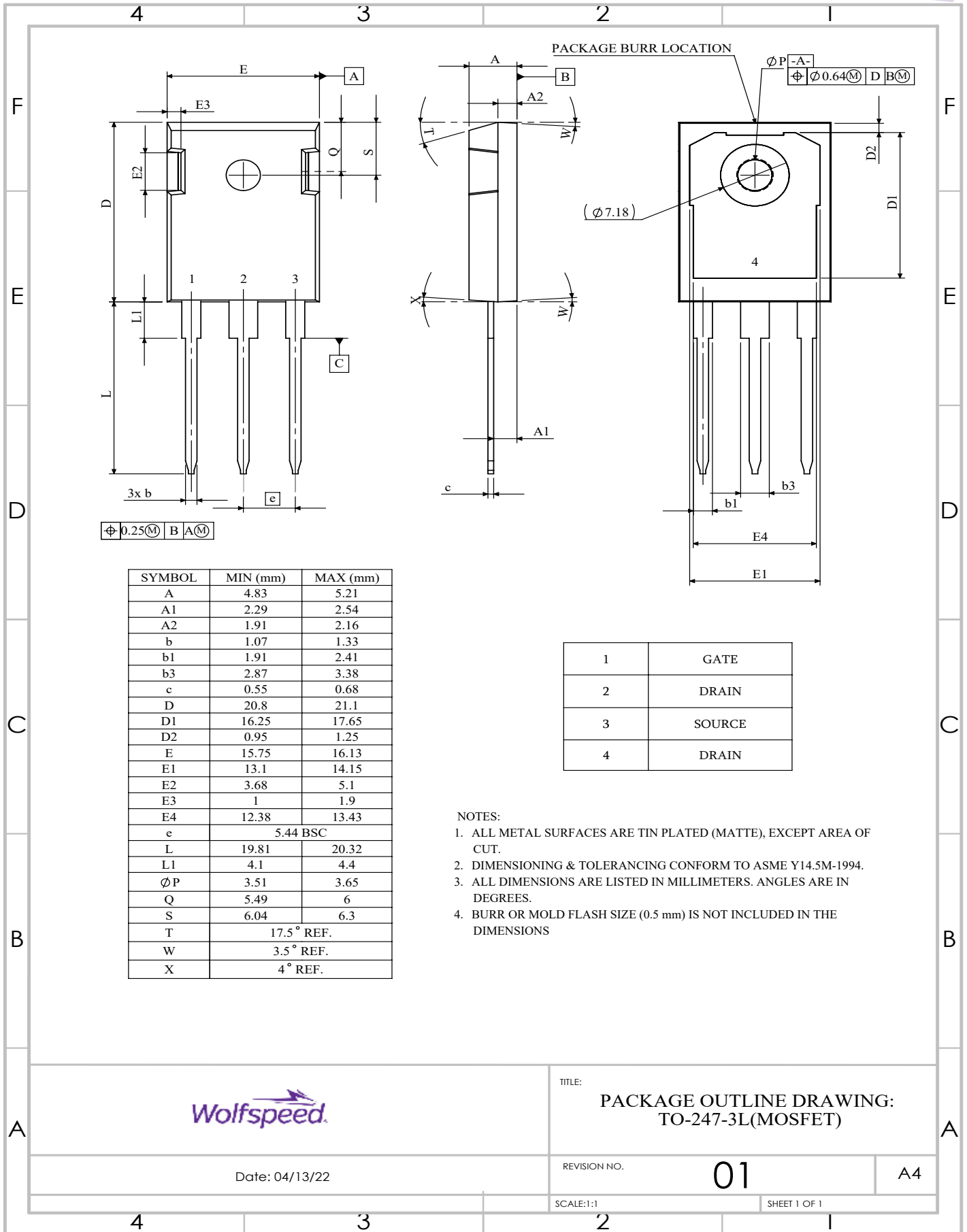

TITLE: PACKAGE OUTLINE DRAWING: TO-247-3L(MOSFET)

Date: 04/13/22

REVISION NO.

01

A4

SCALE:1:1

SHEET 1 OF 1



## Recommended Solder Pad Layout

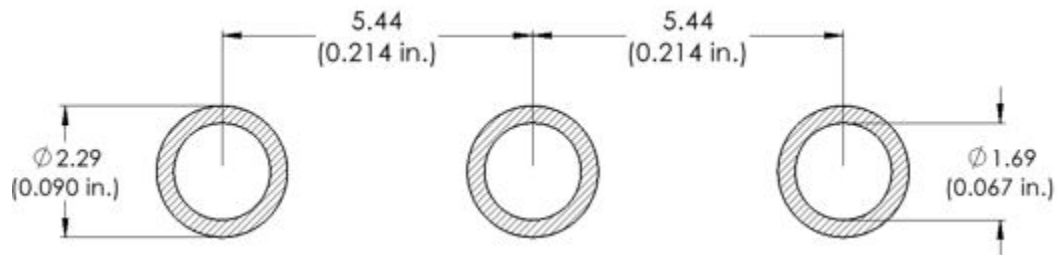

## Revision History

Current Revision	Date of Release	Description of Changes
5	April-2021	N/A
6	November-2023	Updated Wolfspeed branding, package drawing, package image, and solder pad layout, added Revision History Table

## Related Links

- [SPICE Models: http://wolfspeed.com/power/tools-and-support](http://wolfspeed.com/power/tools-and-support)
- [SiC MOSFET Isolated Gate Driver Reference Design: http://wolfspeed.com/power/tools-and-support](http://wolfspeed.com/power/tools-and-support)
- [SiC MOSFET Evaluation Board: http://wolfspeed.com/power/tools-and-support](http://wolfspeed.com/power/tools-and-support)



## Notes & Disclaimer

---

This document and the information contained herein are subject to change without notice. Any such change shall be evidenced by the publication of an updated version of this document by Wolfspeed. No communication from any employee or agent of Wolfspeed or any third party shall effect an amendment or modification of this document. No responsibility is assumed by Wolfspeed for any infringement of patents or other rights of third parties which may result from use of the information contained herein. No license is granted by implication or otherwise under any patent or patent rights of Wolfspeed.

Notwithstanding any application-specific information, guidance, assistance, or support that Wolfspeed may provide, the buyer of this product is solely responsible for determining the suitability of this product for the buyer's purposes, including without limitation for use in the applications identified in the next bullet point, and for the compliance of the buyers' products, including those that incorporate this product, with all applicable legal, regulatory, and safety-related requirements.

This product has not been designed or tested for use in, and is not intended for use in, applications in which failure of the product would reasonably be expected to cause death, personal injury, or property damage, including but not limited to equipment implanted into the human body, life-support machines, cardiac defibrillators, and similar emergency medical equipment, aircraft navigation, communication, and control systems, aircraft power and propulsion systems, air traffic control systems, and equipment used in the planning, construction, maintenance, or operation of nuclear facilities.

The Silicon Carbide MOSFET module switches at speeds beyond what is customarily associated with IGBT-based modules. Therefore, special precautions are required to realize optimal performance. The interconnection between the gate driver and module housing needs to be as short as possible. This will afford optimal switching time and avoid the potential for device oscillation. Also, great care is required to insure minimum inductance between the module and DC link capacitors to avoid excessive VDS overshoot.

### **RoHS Compliance**

The levels of RoHS restricted materials in this product are below the maximum concentration values (also referred to as the threshold limits) permitted for such substances, or are used in an exempted application, in accordance with EU Directive 2011/65/EC (RoHS2), as implemented January 2, 2013. RoHS Declarations for this product can be obtained from your Wolfspeed representative or from the Product Documentation sections of [www.wolfspeed.com](http://www.wolfspeed.com).

### **REACH Compliance**

REACH substances of high concern (SVHCs) information is available for this product. Since the European Chemical Agency (ECHA) has published notice of their intent to frequently revise the SVHC listing for the foreseeable future, please contact your Wolfspeed representative to ensure you get the most up-to-date REACH

### **Contact info:**

4600 Silicon Drive  
Durham, NC 27703 USA  
Tel: +1.919.313.5300  
[www.wolfspeed.com/power](http://www.wolfspeed.com/power)