

C2M0045170D

Silicon Carbide Power MOSFET
C2M™ MOSFET Technology
N-Channel Enhancement Mode



TO-247-3L



Features

- 2nd generation SiC MOSFET technology
- High blocking voltage with low on-resistance
- High speed switching with low capacitances
- Resistant to latch-up
- Halogen free, RoHS compliant

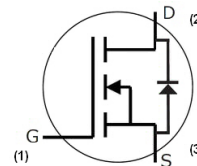

Package Types: TO-247-3L
PN's: C2M0045170D

WolfSpeed, Inc. is in the process of rebranding its products and related materials pursuant to the entity name change from Cree, Inc. to WolfSpeed, Inc. During this transition period, products received may be marked with either the Cree name and/or logo or the WolfSpeed name and/or logo.

Typical Applications

- Solar inverters
- Switch mode power supplies
- High voltage DC/DC converters
- Motor drive
- Pulsed power applications

Benefits

- Higher system efficiency
- Reduced cooling requirements
- Increased power density
- Increased system switching frequency

Key Parameters

Parameter	Symbol	Min.	Typ.	Max	Unit	Conditions	Note
Drain - Source Voltage	V_{DS}			1700	v	$T_c = 25^\circ\text{C}$	
Maximum Gate - Source Voltage	$V_{GS(max)}$	-10		+25		Transient	
Operational Gate-Source Voltage	V_{GSop}		-5/20			Static	Note 1
DC Continuous Drain Current	I_D			75	A	$V_{GS} = 20\text{ V}, T_c = 25^\circ\text{C}, T_J \leq 150^\circ\text{C}$	Fig. 19
				48		$V_{GS} = 20\text{ V}, T_c = 100^\circ\text{C}, T_J \leq 150^\circ\text{C}$	Note 2
Pulsed Drain Current	I_{DM}			160		t_{Pmax} limited by T_{Jmax} $V_{GS} = 20\text{ V}, T_c = 25^\circ\text{C}$	Fig. 22
Power Dissipation	P_D			338	W	$T_c = 25^\circ\text{C}, T_J = 150^\circ\text{C}$	Fig. 20
Operating Junction and Storage Temperature	T_J, T_{stg}			-40 to +150	$^\circ\text{C}$		
Solder Temperature	T_L			260		According to JEDEC J-STD-020	
Mounting Torque	M_D			1 8.8	Nm lbf-in	M3 or 6-32 screw	

Note (1): Recommended turn-on gate voltage is 20V with $\pm 5\%$ regulation tolerance, see Application Note PRD-04814 for additional details

Note (2): Verified by design

Electrical Characteristics ($T_C = 25\text{ }^\circ\text{C}$ Unless Otherwise Specified)

Parameter	Symbol	Min.	Typ.	Max.	Unit	Test Conditions	Note
Drain-Source Breakdown Voltage	$V_{(BR)DSS}$	1700				$V_{GS} = 0\text{ V}, I_D = 100\text{ }\mu\text{A}$	
Gate Threshold Voltage	$V_{GS(th)}$	2.0	3.0	4	V	$V_{DS} = V_{GS}, I_D = 18\text{ mA}$	Fig. 11
			2.5			$V_{DS} = V_{GS}, I_D = 18\text{ mA}, T_J = 150\text{ }^\circ\text{C}$	
Zero Gate Voltage Drain Current	I_{DSS}		2	100	μA	$V_{DS} = 1700\text{ V}, V_{GS} = 0\text{ V}$	
Gate-Source Leakage Current	I_{GSS}			600	nA	$V_{GS} = 20\text{ V}, V_{DS} = 0\text{ V}$	
Drain-Source On-State Resistance	$R_{DS(on)}$		40	70	m Ω	$V_{GS} = 20\text{ V}, I_D = 50\text{ A}$	Fig. 4,5,6
			80			$V_{GS} = 20\text{ V}, I_D = 50\text{ A}, T_J = 150\text{ }^\circ\text{C}$	
Transconductance	g_{fs}		24.7		S	$V_{DS} = 20\text{ V}, I_{DS} = 50\text{ A}$	Fig. 7
			23.4			$V_{DS} = 20\text{ V}, I_{DS} = 50\text{ A}, T_J = 150\text{ }^\circ\text{C}$	
Input Capacitance	C_{iss}		3455		pF	$V_{GS} = 0\text{ V}$ $V_{DS} = 1200\text{ V}$ $f = 1\text{ MHz}$ $V_{AC} = 25\text{ mV}$	Fig. 17,18
Output Capacitance	C_{oss}		171				
Reverse Transfer Capacitance	C_{rss}		6.7				
C_{oss} Stored Energy	E_{oss}		139		μJ		Fig. 16
Effective Output Capacitance (Energy Related)	$C_{o(er)}$		188		pF	$V_{GS} = 0\text{ V}, V_{DS} = 0 \dots 1200\text{ V}$	Note: 3
Effective Output Capacitance (Time Related)	$C_{o(tr)}$		255		pF		
Turn-On Switching Energy (SiC Diode FWD)	E_{ON}		2.5		mJ	$V_{DS} = 1200\text{ V}, V_{GS} = -5/20\text{ V},$ $I_D = 50\text{ A}, R_{G(ext)} = 2.5\text{ }\Omega, L = 99\text{ }\mu\text{H},$ $T_J = 150\text{ }^\circ\text{C},$ Using SiC Diode as FWD	Fig. 26, 29b Note 2
Turn Off Switching Energy (SiC Diode FWD)	E_{OFF}		1.4				
Turn-On Switching Energy (Body Diode FWD)	E_{ON}		4.9		mJ	$V_{DS} = 1200\text{ V}, V_{GS} = -5/20\text{ V},$ $I_D = 50\text{ A}, R_{G(ext)} = 2.5\text{ }\Omega, L = 99\text{ }\mu\text{H},$ $T_J = 150\text{ }^\circ\text{C},$ Using MOSFET as FWD	Fig. 26, 29a Note 2
Turn Off Switching Energy (Body Diode FWD)	E_{OFF}		1.1				
Turn-On Delay Time	$t_{d(on)}$		68		ns	$V_{DD} = 1200\text{ V}, V_{GS} = -5/20\text{ V}$ $I_D = 50\text{ A},$ $R_{G(ext)} = 2.5\text{ }\Omega,$ Timing Relative to V_{DS} Inductive Load	Fig. 27, 29 Note 2
Rise Time	t_r		19				
Turn-Off Delay Time	$t_{d(off)}$		35				
Fall Time	t_f		19				
Internal Gate Resistance	$R_{G(int)}$		1.3		Ω	$f = 1\text{ MHz}, V_{AC} = 25\text{ mV}$	
Gate to Source Charge	Q_{gs}		43		nC	$V_{DS} = 1200\text{ V}, V_{GS} = -5/20\text{ V}$ $I_D = 50\text{ A}$ Per IEC60747-8-4 pg 21	Fig. 12
Gate to Drain Charge	Q_{gd}		74				
Total Gate Charge	Q_g		200				

Note (3): $C_{o(er)}$, a lumped capacitance that gives same stored energy as C_{oss} while V_{DS} is rising from 0 to 1200 V.

$C_{o(tr)}$, a lumped capacitance that gives same charging time as C_{oss} while V_{DS} is rising from 0 to 1200 V.



Reverse Diode Characteristics

Parameter	Symbol	Typ.	Max.	Unit	Test Conditions	Note
Diode Forward Voltage	V_{SD}	3.8		V	$V_{GS} = -5\text{ V}, I_{SD} = 25\text{ A}$	Fig. 8, 9, 10 Note 1
		3.4			$V_{GS} = -5\text{ V}, I_{SD} = 25\text{ A}, T_J = 150\text{ }^\circ\text{C}$	
Continuous Diode Forward Current	I_S		76	A	$V_{GS} = -5\text{ V}, T_C = 25\text{ }^\circ\text{C}$	Note 1
Diode Pulse Current	I_{SM}		160		$V_{GS} = -5\text{ V}$, Pulse Width t_p Limited by T_{Jmax}	Note 1
Reverse Recovery Time	t_{rr}	53		ns	$V_{GS} = -5\text{ V}, I_{SD} = 50\text{ A}, V_R = 1200\text{ V}$ $dif/dt = 1000\text{ A}/\mu\text{s}, T_J = 150\text{ }^\circ\text{C}$	
Reverse Recovery Charge	Q_{rr}	461		μC		
Peak Reverse Recovery Current	I_{rrm}	14		A		
Reverse Recovery Time	t_{rr}	40		ns	$V_{GS} = -5\text{ V}, I_{SD} = 50\text{ A}, V_R = 1200\text{ V}$ $dif/dt = 3040\text{ A}/\mu\text{s}, T_J = 150\text{ }^\circ\text{C}$	
Reverse Recovery Charge	Q_{rr}	481		μC		
Peak Reverse Recovery Current	I_{rrm}	22		A		

Thermal Characteristics

Parameter	Symbol	Typ.	Max.	Unit	Test Conditions	Note
Thermal Resistance from Junction to Case	$R_{\theta JC}$	0.25	0.37	$^\circ\text{C}/\text{W}$		Fig. 21
Thermal Resistance from Junction to Ambient	$R_{\theta JA}$		40			



Typical Performance

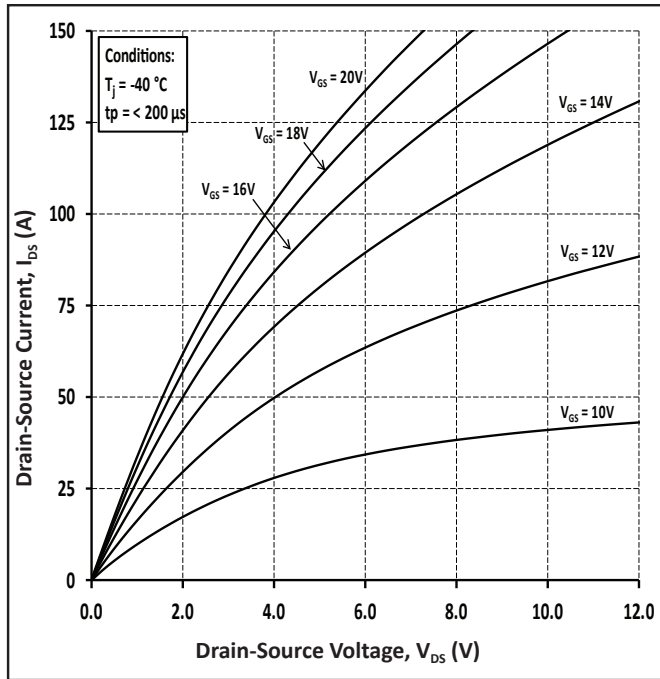

Figure 1. Output Characteristics $T_j = -40\text{ }^\circ\text{C}$

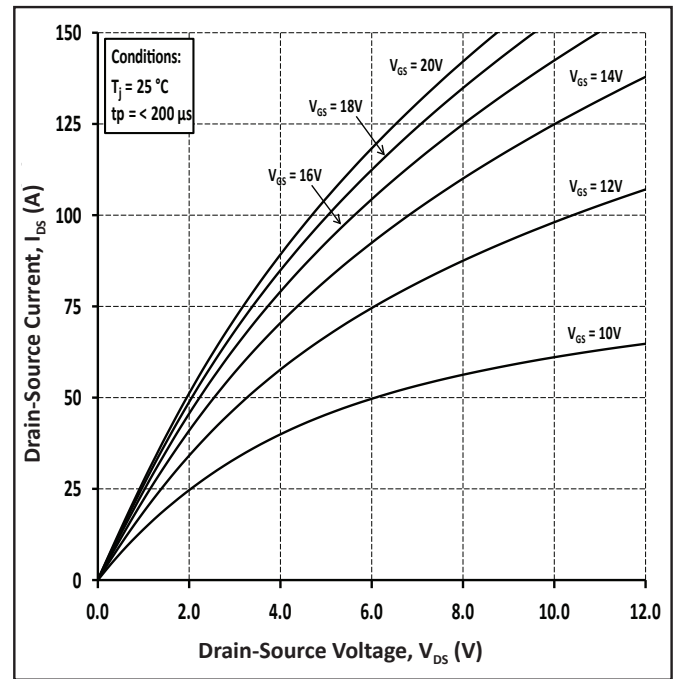

Figure 2. Output Characteristics $T_j = 25\text{ }^\circ\text{C}$

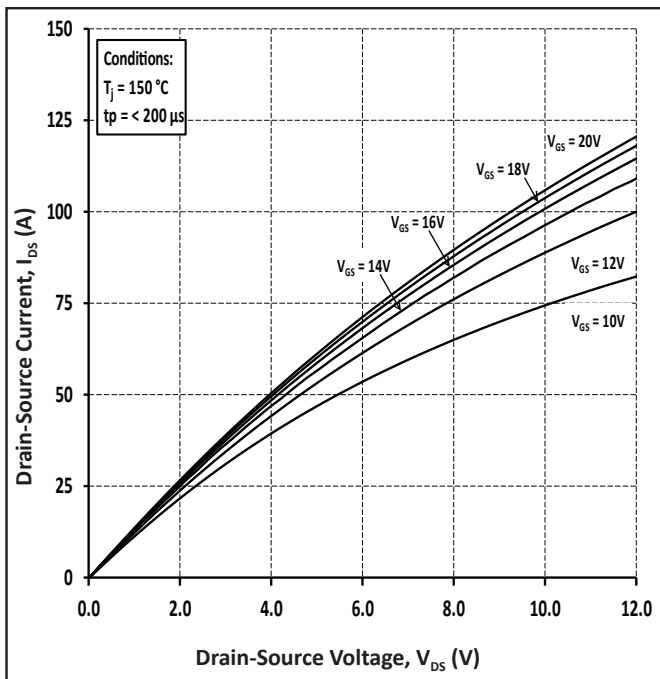

Figure 3. Output Characteristics $T_j = 150\text{ }^\circ\text{C}$

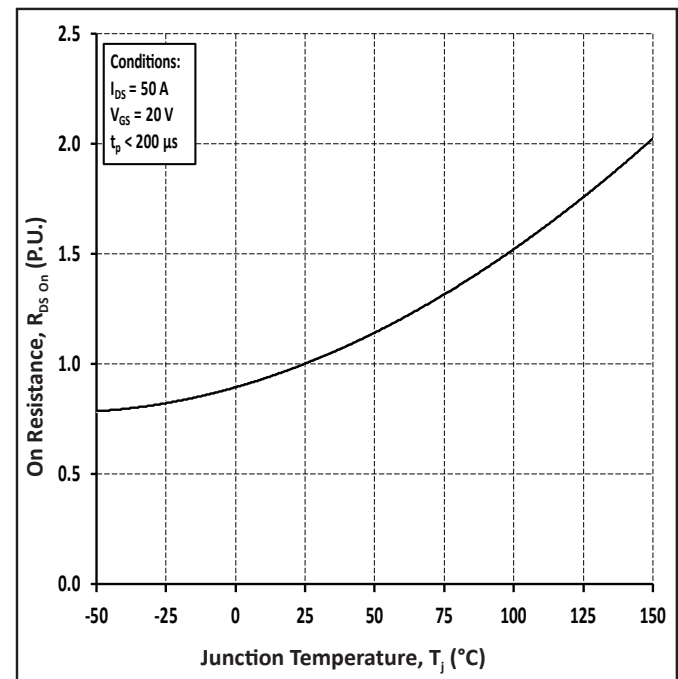

Figure 4. Normalized On-Resistance vs Temperature



Typical Performance

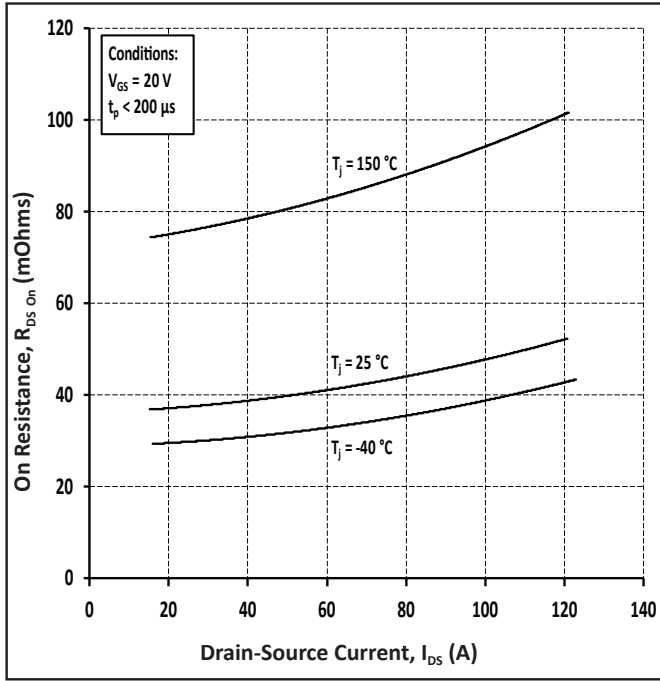

Figure 5. On-Resistance vs Drain Current for Various Temperatures

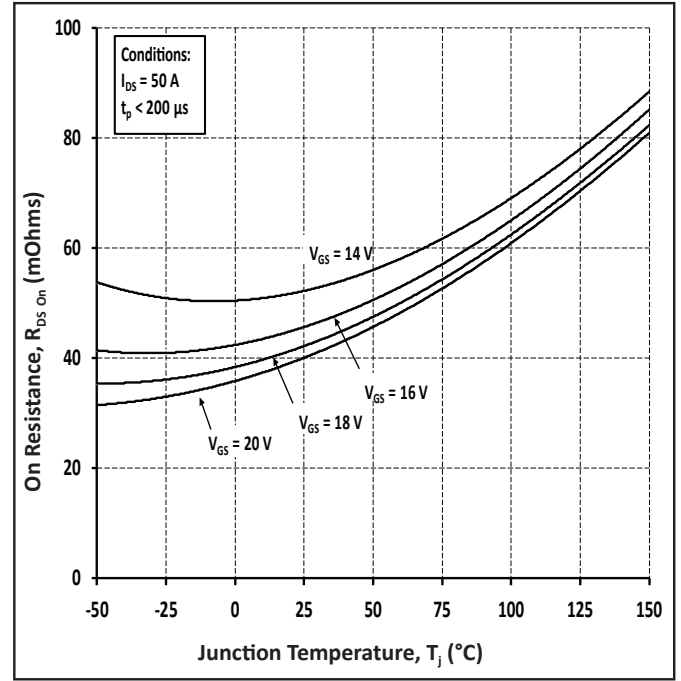

Figure 6. On-Resistance vs Temperature for Various Gate Voltage

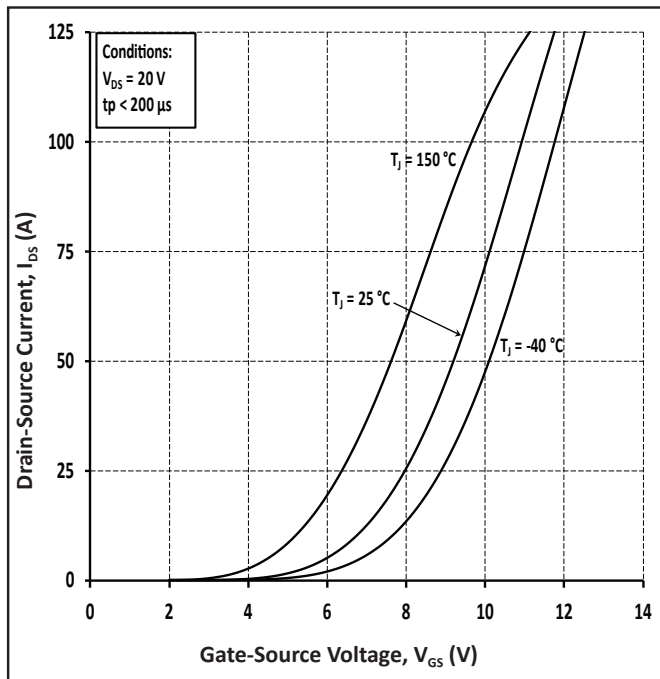

Figure 7. Transfer Characteristic for Various Junction Temperatures

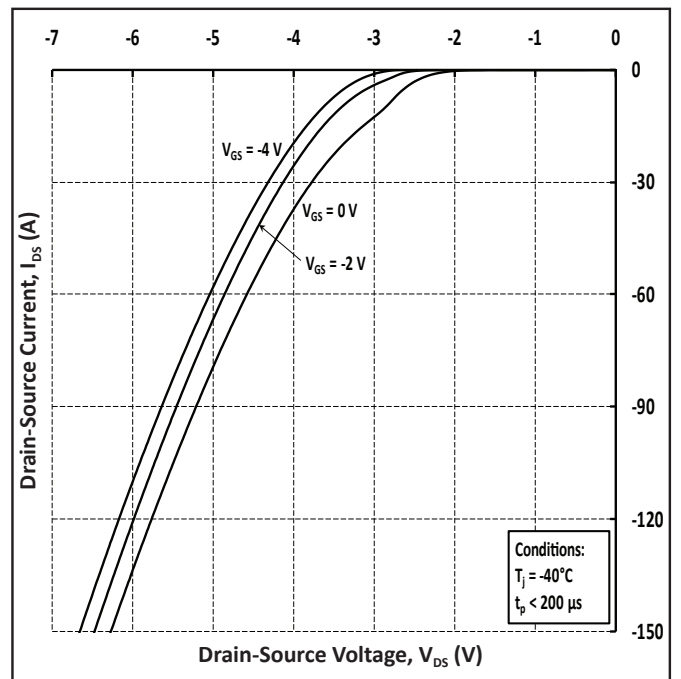

Figure 8. Body Diode Characteristic at -40 °C



Typical Performance

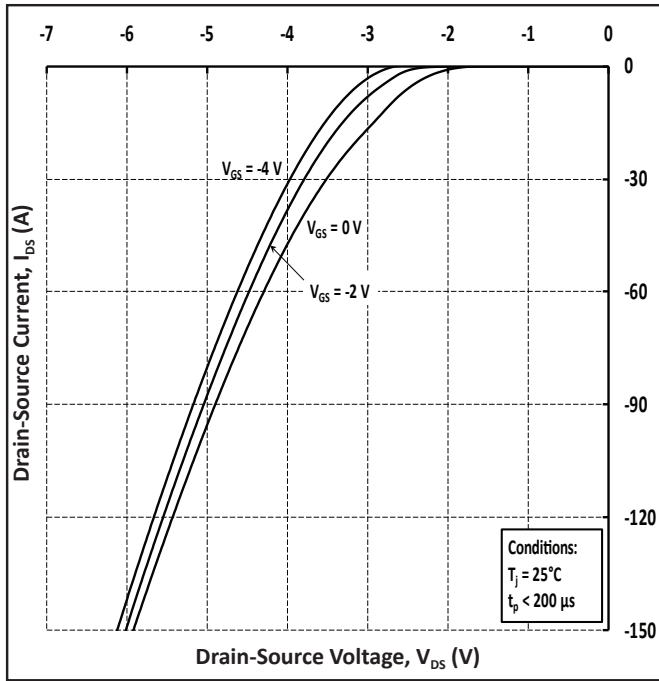

Figure 9. Body Diode Characteristic at 25 °C

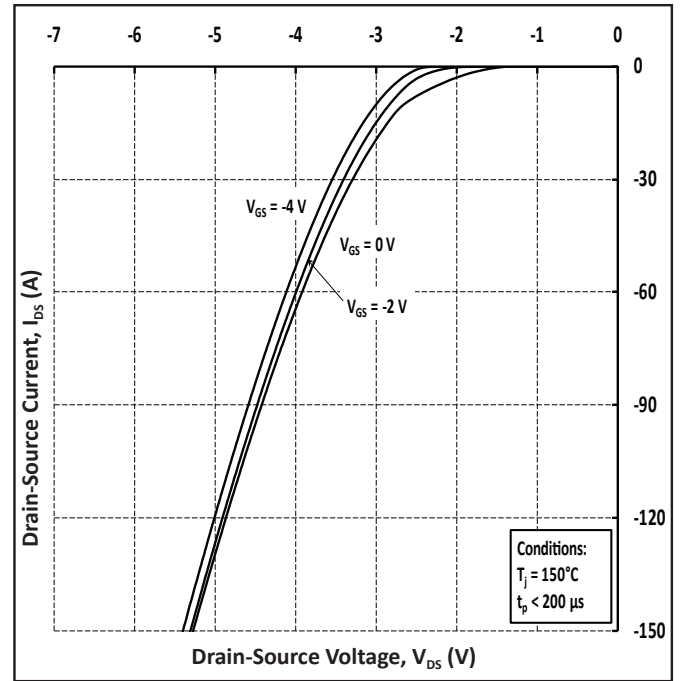

Figure 10. Body Diode Characteristic at 150 °C

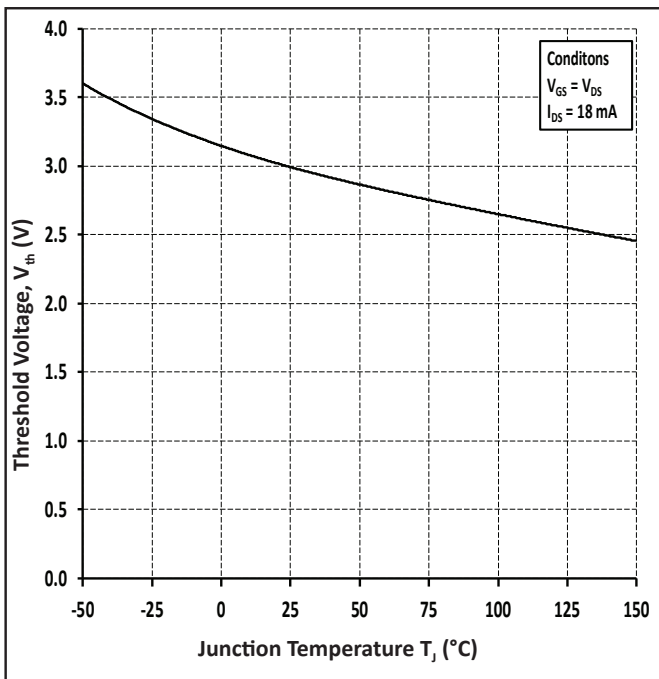

Figure 11. Threshold Voltage vs Temperature

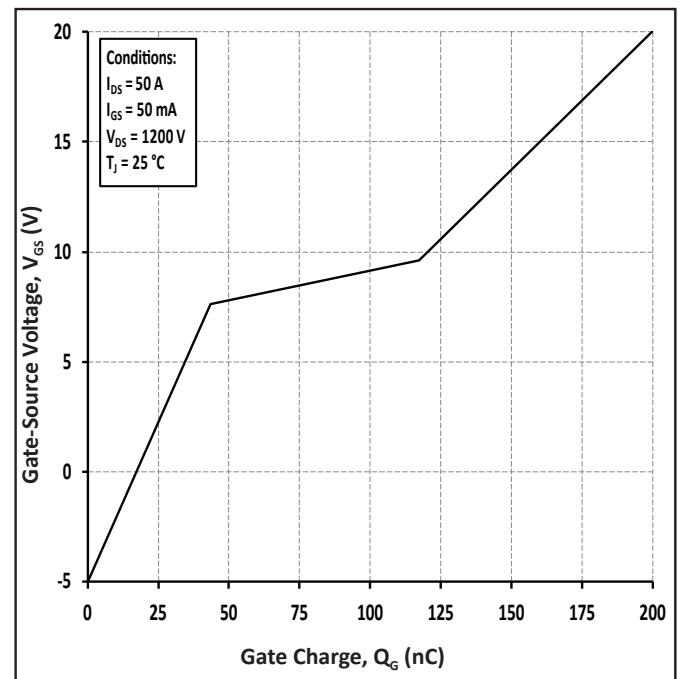

Figure 12. Gate Charge Characteristic



Typical Performance

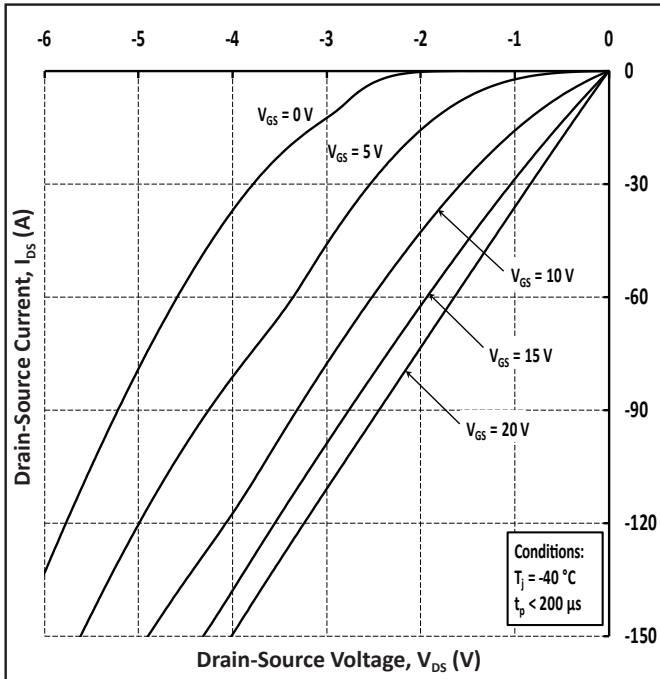

Figure 13. 3rd Quadrant Characteristic at $-40\text{ }^\circ\text{C}$

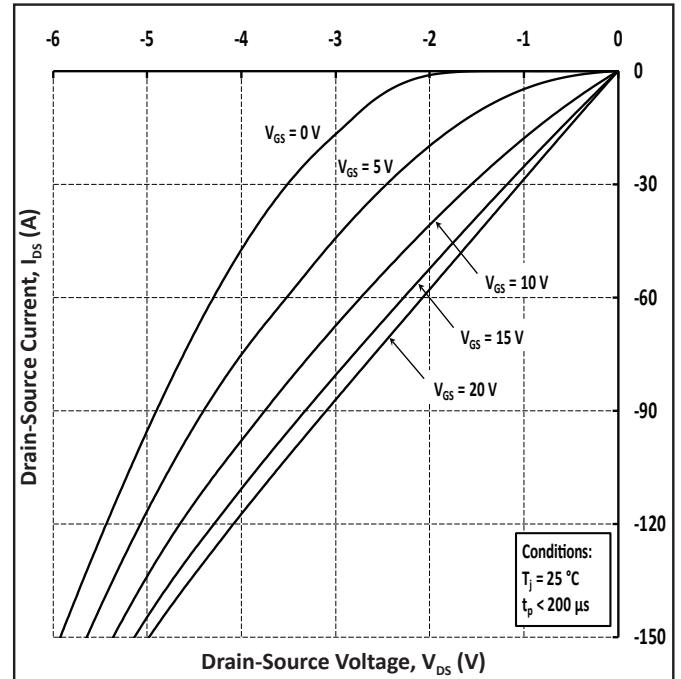

Figure 14. 3rd Quadrant Characteristic at $25\text{ }^\circ\text{C}$

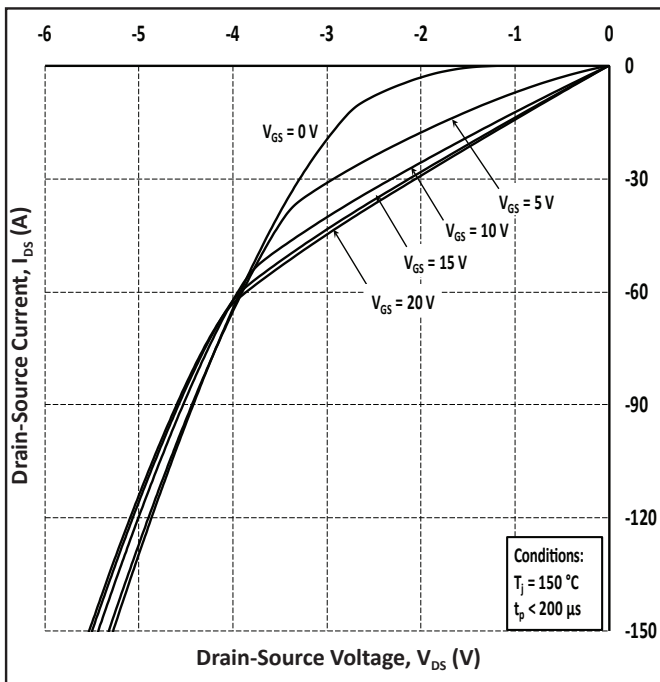

Figure 15. 3rd Quadrant Characteristic at $150\text{ }^\circ\text{C}$

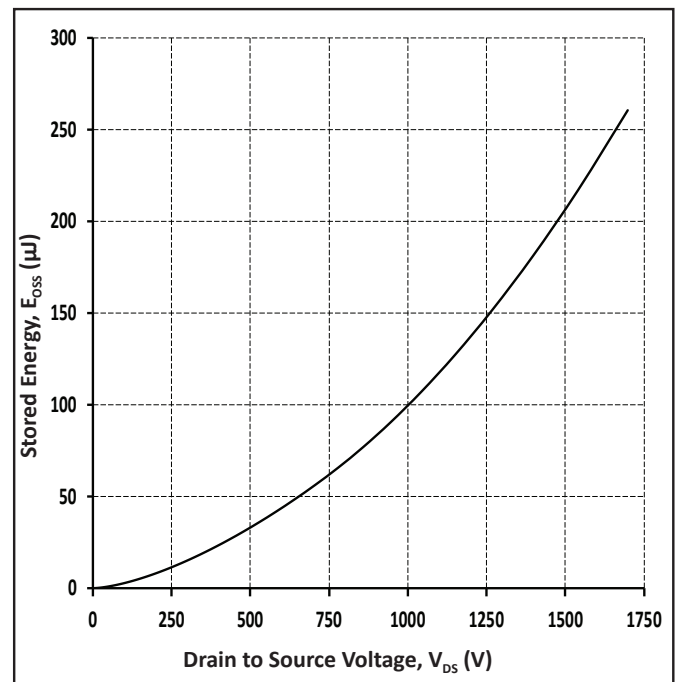

Figure 16. Output Capacitor Stored Energy



Typical Performance

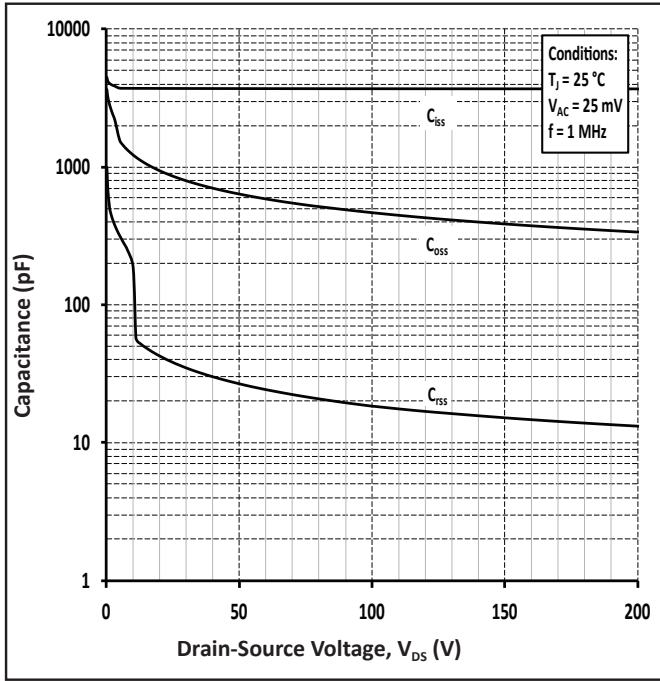

Figure 17. Capacitances vs Drain-Source Voltage (0-200 V)

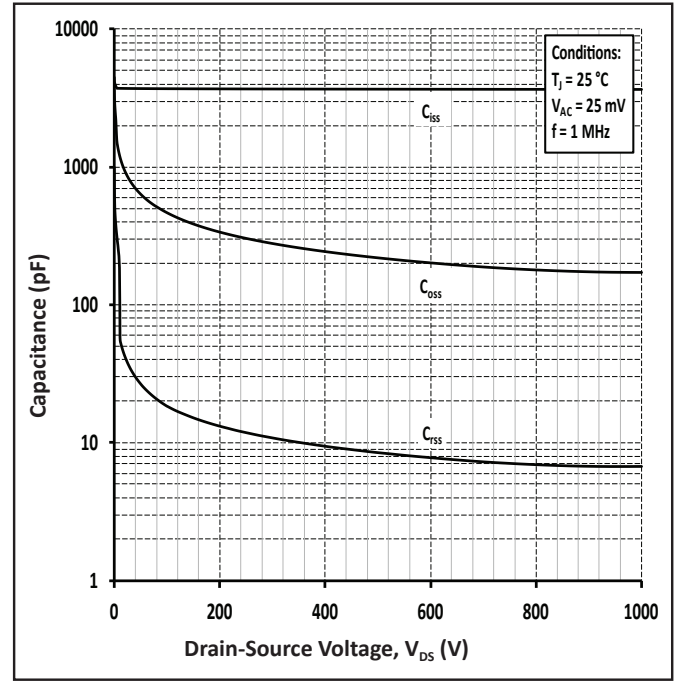

Figure 18. Capacitances vs Drain-Source Voltage (0-1000 V)

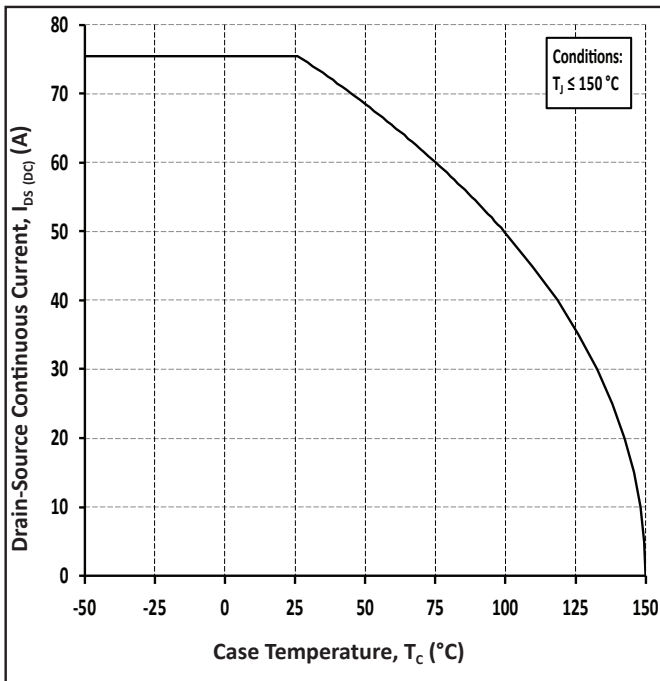

Figure 19. Continuous Drain Current Derating vs Case Temperature

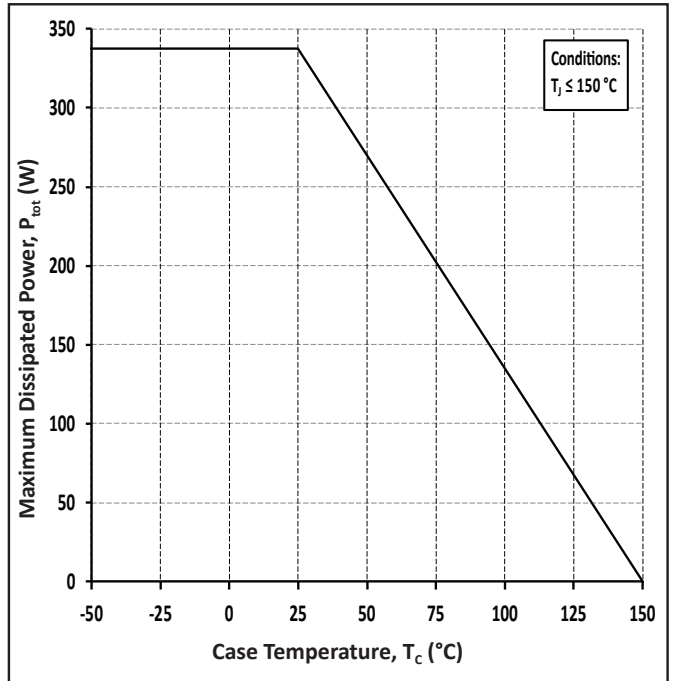

Figure 20. Maximum Power Dissipation Derating vs Case Temperature

Typical Performance

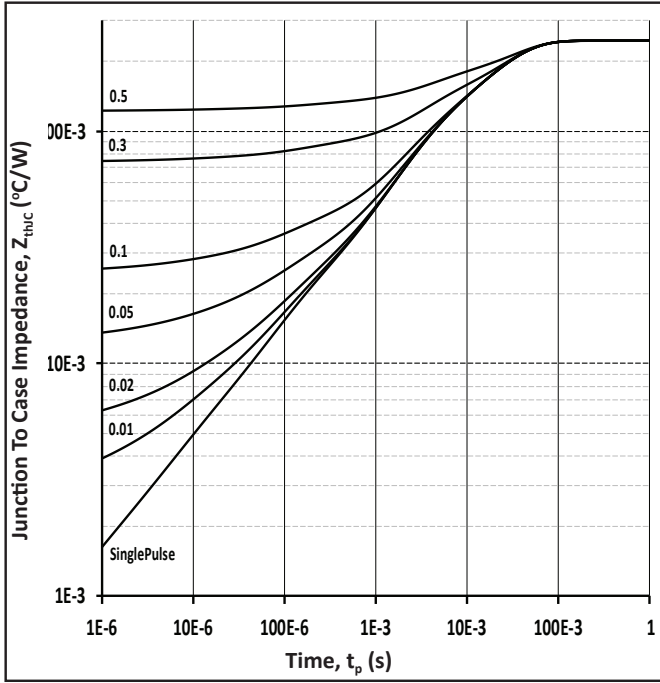

Figure 21. Transient Thermal Impedance (Junction - Case)

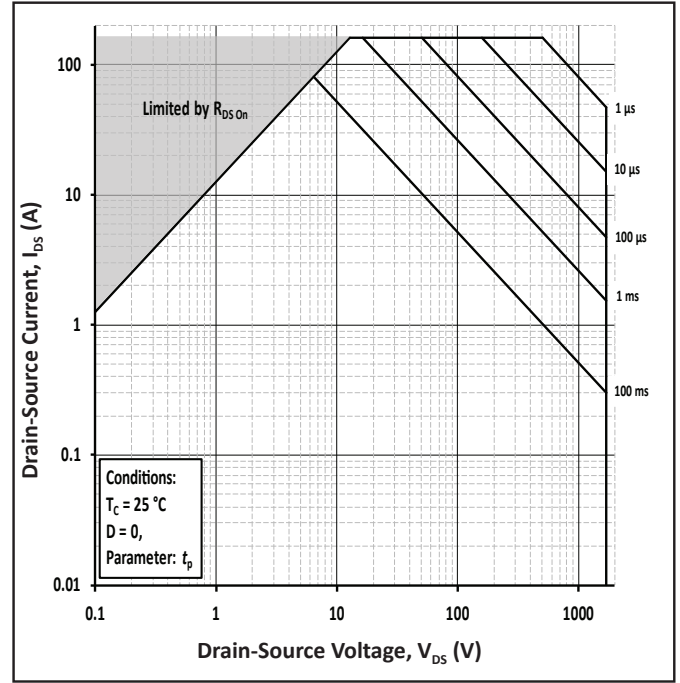

Figure 22. Safe Operating Area

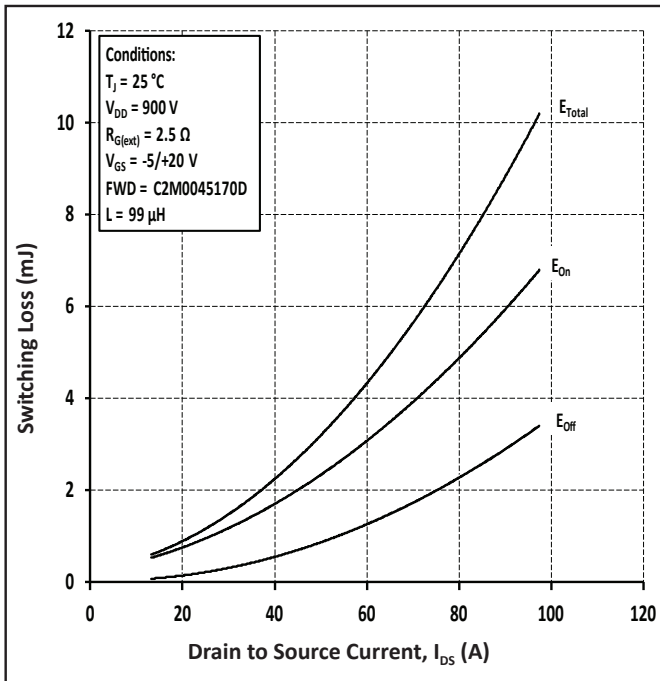

Figure 23. Clamped Inductive Switching Energy vs Drain Current ($V_{DD} = 900\text{ V}$)

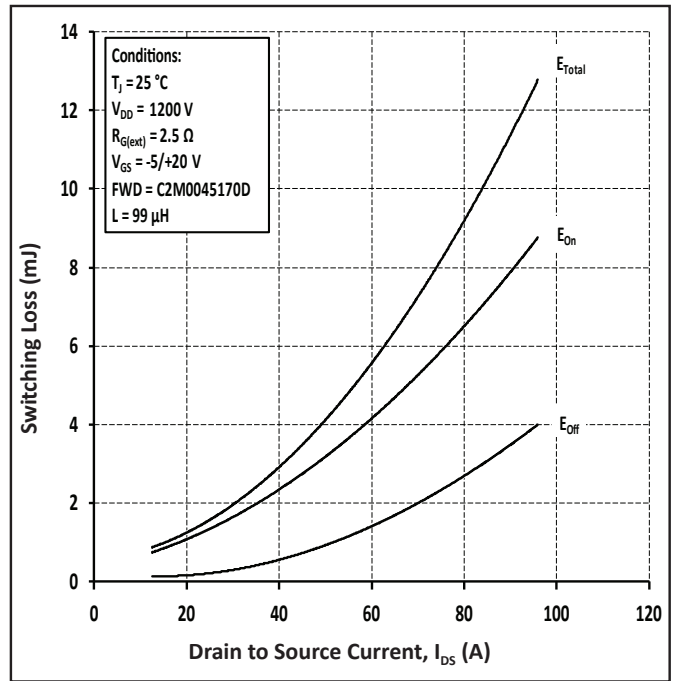

Figure 24. Clamped Inductive Switching Energy vs Drain Current ($V_{DD} = 1200\text{ V}$)



Typical Performance

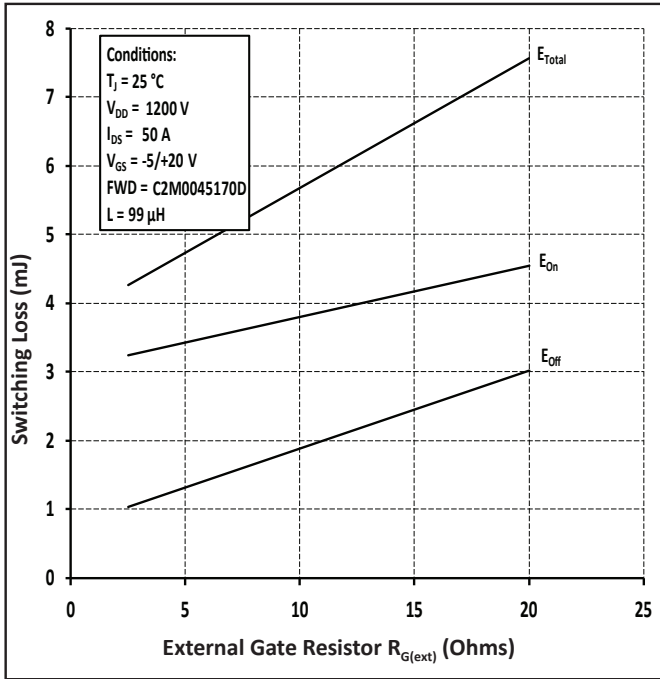

Figure 25. Clamped Inductive Switching Energy vs $R_{G(ext)}$

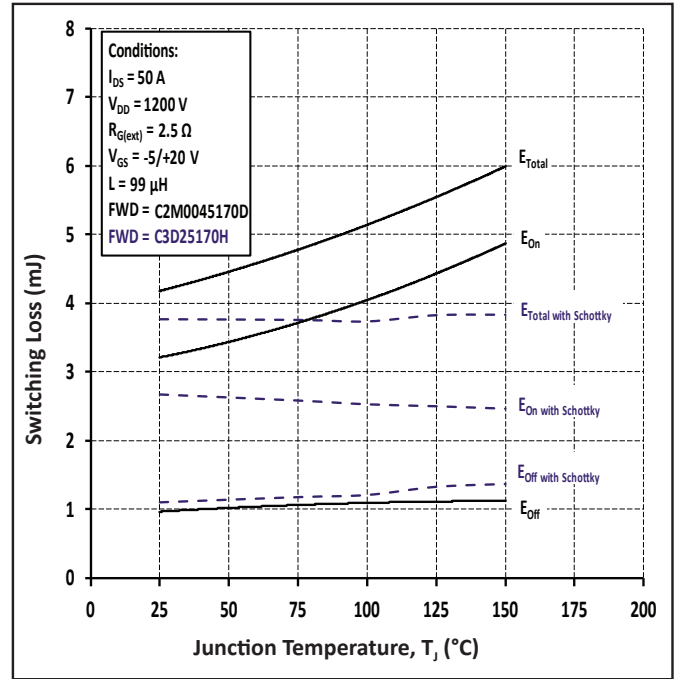

Figure 26. Clamped Inductive Switching Energy vs Temperature

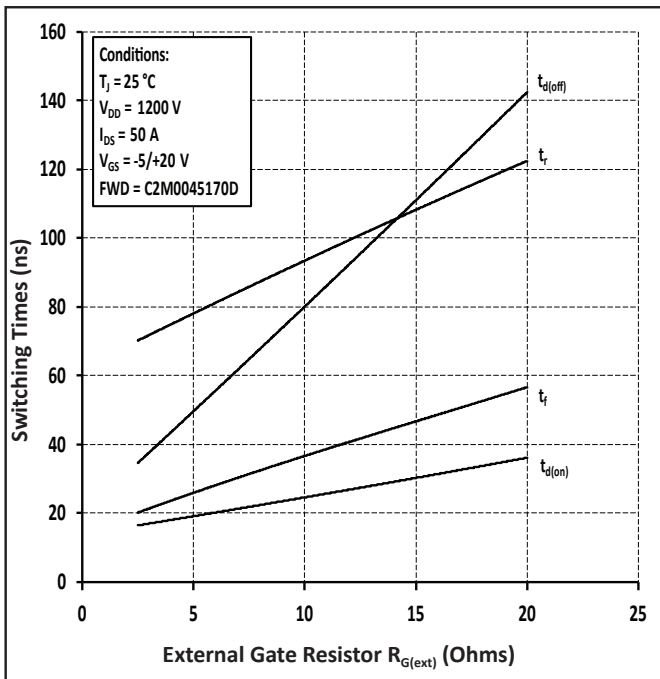

Figure 27. Switching Times vs $R_{G(ext)}$

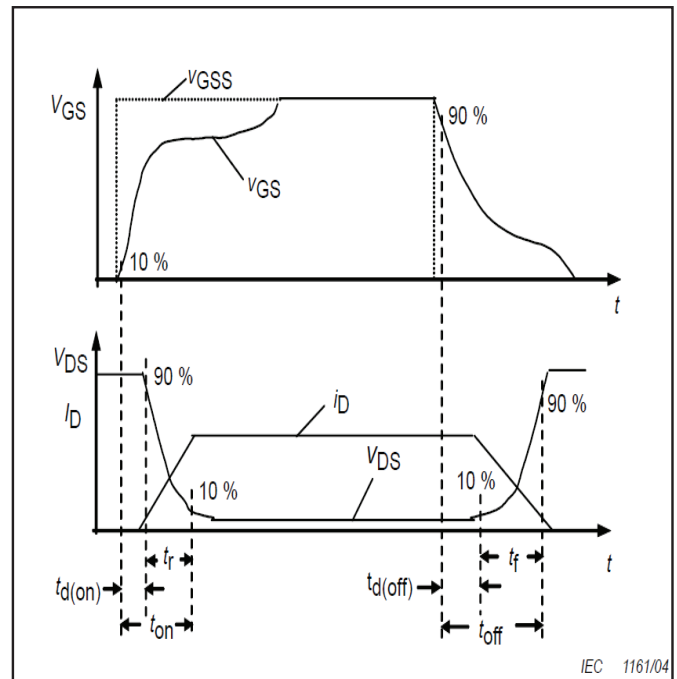

Figure 28. Switching Times Definition



Test Circuit Schematic

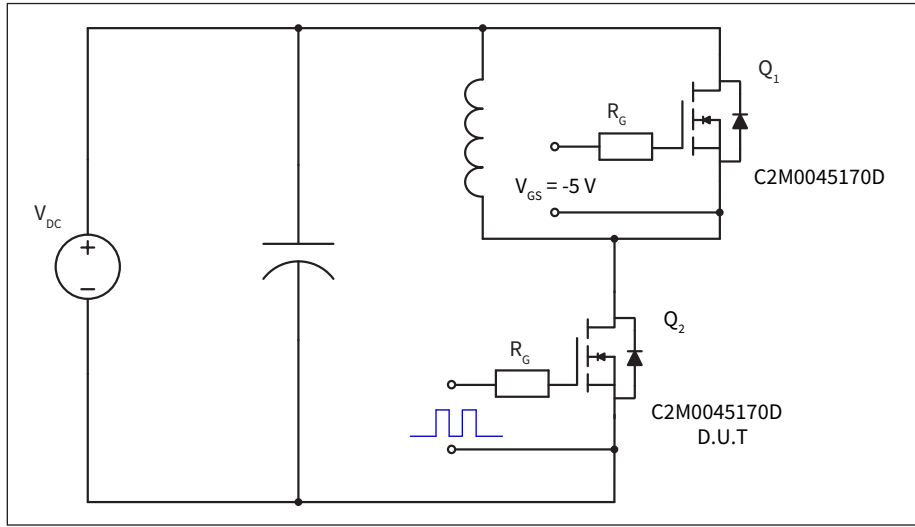

Figure 29a. Clamped Inductive Switching Test Circuit Using MOSFET Intrinsic Body Diode

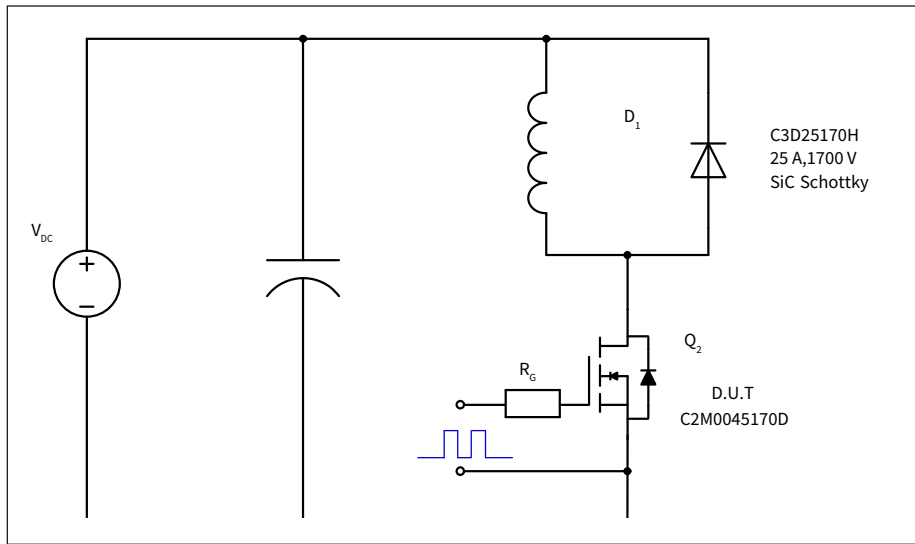
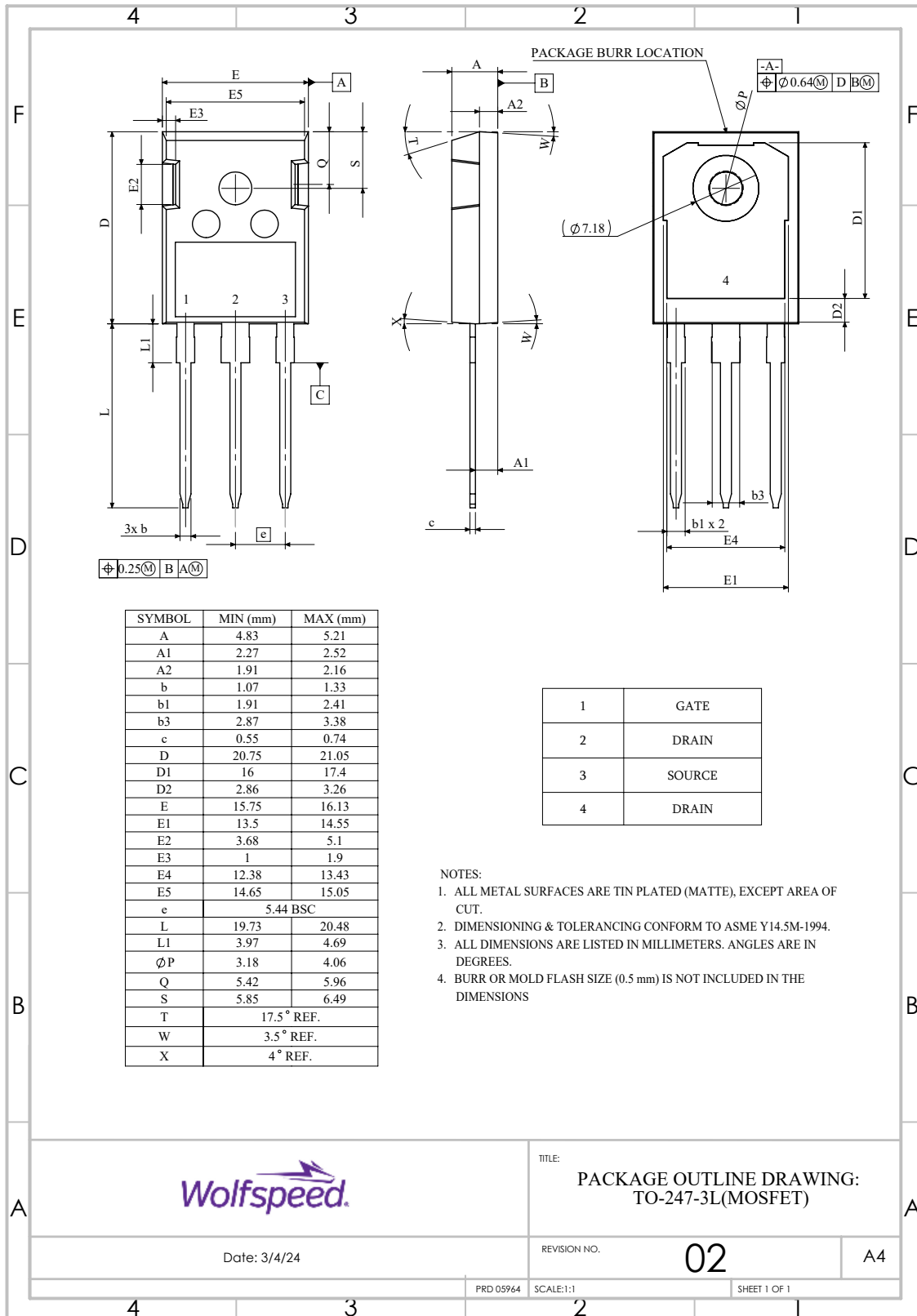

Figure 29b. Clamped Inductive Switching Test Circuit Using SiC Schottky Diode



Package Dimensions

Package: TO-247-3L





Recommended Solder Pad Layout

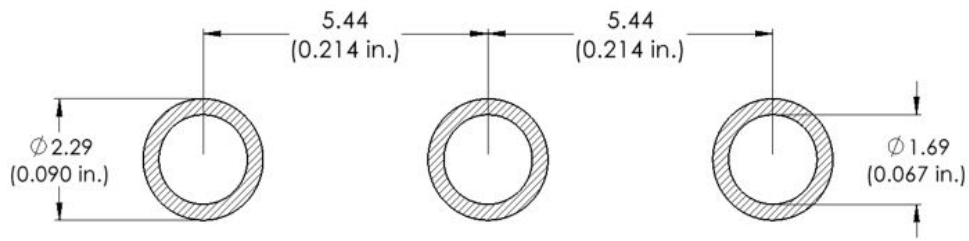



Revision History

Current Revision	Date of Release	Description of Changes
0	May-2022	Initial Release
1	November-2023	Updated Wolfspeed branding, package drawing, and solder pad layout
2	February-2024	Qrr units corrected to uC
3	October - 2024	Legal Disclaimer, POD, Table 1 layout, Diode Pulse Current Symbol



Notes & Disclaimer

WOLFSPPEED PROVIDES TECHNICAL AND RELIABILITY DATA, DESIGN RESOURCES, APPLICATION OR OTHER DESIGN ADVICE, WEB TOOLS, AND OTHER RESOURCES “AS IS” AND WITH ALL FAULTS, AND DISCLAIMS ALL WARRANTIES, EXPRESS AND IMPLIED, WITH RESPECT THERETO, INCLUDING WITHOUT LIMITATION ANY IMPLIED WARRANTIES OF MERCHANTABILITY, SUITABILITY, FITNESS FOR A PARTICULAR PURPOSE, OR NON-INFRINGEMENT OF THIRD-PARTY INTELLECTUAL PROPERTY RIGHTS.

This document and the information contained herein are subject to change without notice. Any such change shall be evidenced by the publication of an updated version of this document by Wolfsppeed. No communication from any employee or agent of Wolfsppeed or any third party shall effect an amendment or modification of this document. No responsibility is assumed by Wolfsppeed for any infringement of patents or other rights of third parties which may result from use of the information contained herein. No license is granted by implication or otherwise under any patent or patent rights of Wolfsppeed.

The information contained in this document (excluding examples, as well as figures or values that are labeled as “typical”) constitutes Wolfsppeed’s sole published specifications for the subject product. “Typical” parameters are the average values expected by Wolfsppeed in large quantities and are provided for informational purposes only. Any examples provided herein have not been produced under conditions intended to replicate any specific end use. Product performance can and does vary due to a number of factors.

This product has not been designed or tested for use in, and is not intended for use in, any application in which failure of the product would reasonably be expected to cause death, personal injury, or property damage. For purposes of (but without limiting) the foregoing, this product is not designed, intended, or authorized for use as a critical component in equipment implanted into the human body, life-support machines, cardiac defibrillators, and similar emergency medical equipment; air traffic control systems; or equipment used in the planning, construction, maintenance, or operation of nuclear facilities. Notwithstanding any application-specific information, guidance, assistance, or support that Wolfsppeed may provide, the buyer of this product is solely responsible for determining the suitability of this product for the buyer’s purposes, including without limitation (1) selecting the appropriate Wolfsppeed products for the buyer’s application, (2) designing, validating, and testing the buyer’s application, and (3) ensuring the buyer’s application meets applicable standards and any other legal, regulatory, and safety-related requirements.

RoHS Compliance

The levels of RoHS restricted materials in this product are below the maximum concentration values (also referred to as the threshold limits) permitted for such substances, or are used in an exempted application, in accordance with EU Directive 2011/65/EC (RoHS2), as implemented January 2, 2013. RoHS Declarations for this product can be obtained from your Wolfsppeed representative or from the Product Documentation sections of www.wolfsppeed.com.

REACH Compliance

REACH substances of high concern (SVHCs) information is available for this product. Since the European Chemical Agency (ECHA) has published notice of their intent to frequently revise the SVHC listing for the foreseeable future, please contact your Wolfsppeed representative to ensure you get the most up-to-date REACH SVHC Declaration. REACH banned substance information (REACH Article 67) is also available upon request. SVHC Declaration. REACH banned substance information (REACH Article 67) is also available upon request.

Contact info:

4600 Silicon Drive
Durham, NC 27703 USA
Tel: +1.919.313.5300
www.wolfsppeed.com/power

© 2024 Wolfsppeed, Inc. All rights reserved. Wolfsppeed® and the Wolfstreak logo are registered trademarks and the Wolfsppeed logo is a trademark of Wolfsppeed, Inc.
PATENT: <https://www.wolfsppeed.com/legal/patents>

The information in this document is subject to change without notice.