

Figure 9. Package D15: TO-5 with Glass Window.

Ordering Guide

C30 # # # L - X X X

- TE-Cooler Option:
 - TC: 1-stage TE cooler
 - DTC: 2-stage TE cooler (Not yet available for C30665)
- Window Option:
 - E: Silicon
 - G: Glass (See below for availability)
- Chip Type:
 - 619: 0.5mm diameter
 - 641: 1.0mm diameter
 - 642: 2.0mm diameter
 - 665: 3.0mm diameter

Device Package Availability

Window Option	Window Type	Package Type			
		C30619	C30641	C30642	C30665
E	Silicon	D2 ¹	D2 ¹	-	-
G	Glass	D14	D14	D15	D15

Note 1: Special Order

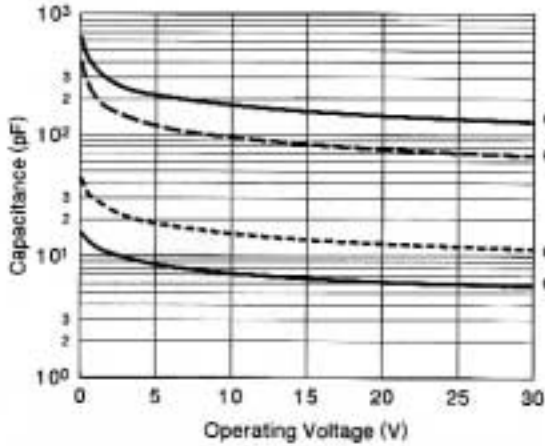

Figure 3. Typical Capacitance vs. Operating Voltage.

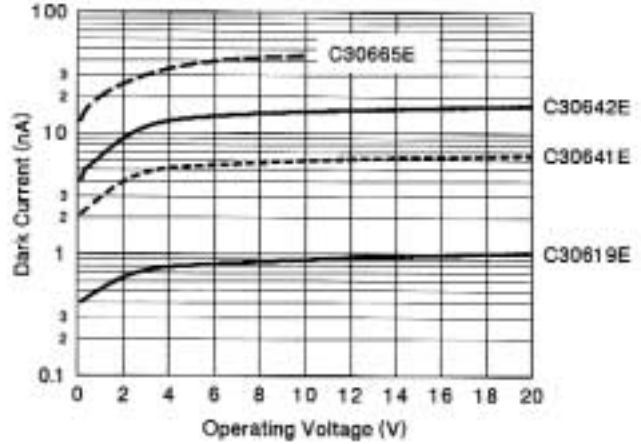

Figure 4. Typical Dark Current vs. Operating Voltage.

Wavelength (nm)	Temperature Coefficient ¹ (%/°C)
850	-0.121
1060	0.039
1300	0.012
1550	0.009
1650	0.085 (20°C to 85°C)
	1.287 (-40°C to 20°C)

Note1: Measured from -40°C to +85°C except 1650nm, as indicated.

Figure 5. Typical Responsivity Temperature Coefficients.

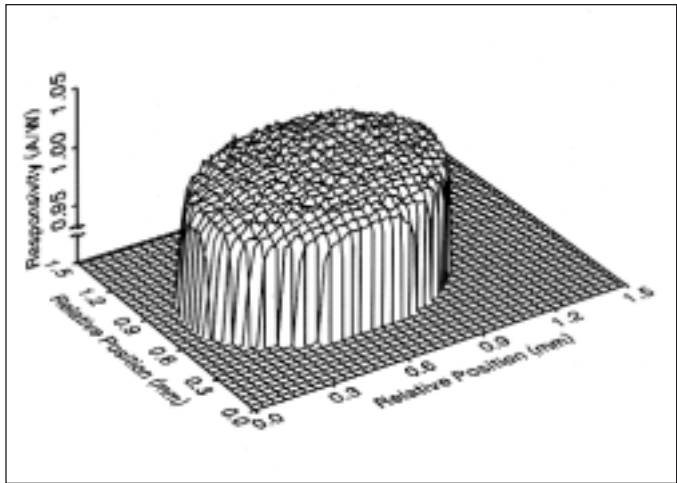

Figure 6. Typical Responsivity Scan of a 1mm Photodiode.

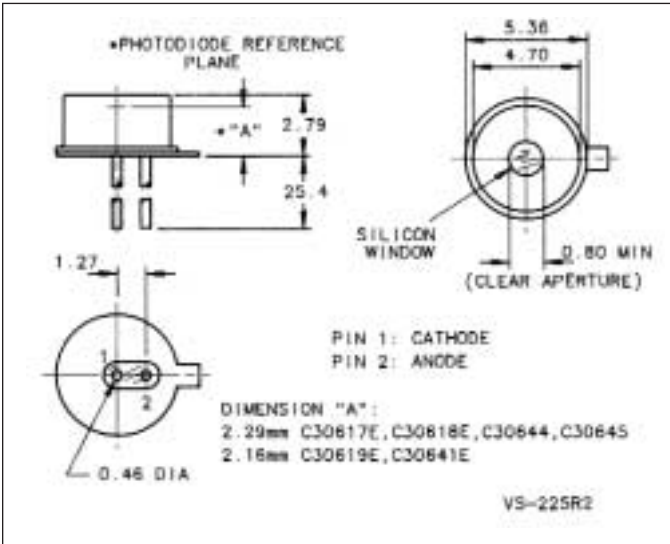

Figure 7. Package D2: TO-18 Low Profile with Silicon Window. To special order.

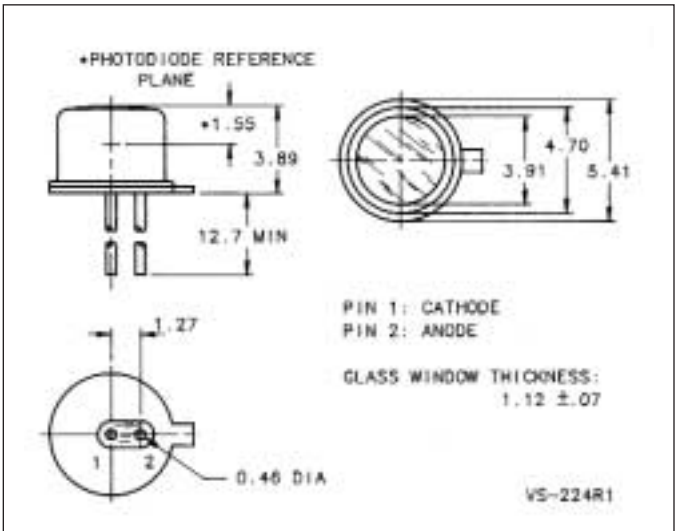

Figure 8. Package D-14: TO-18 with Glass Window.

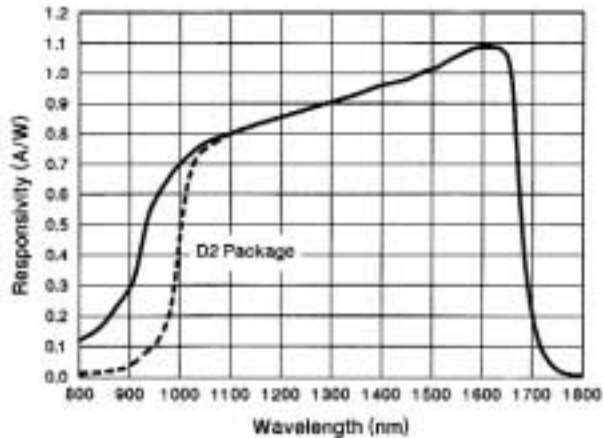

Figure 1. Typical Responsivity vs. Wavelength.

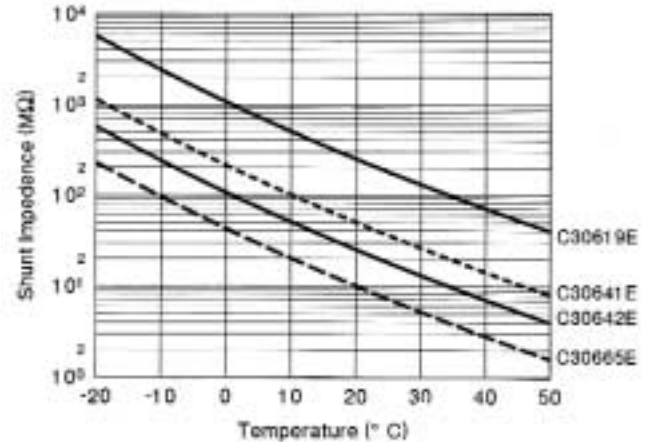

Figure 2. Typical Shunt Resistance as a Function of Temperature.

Specifications (at $V_R = V_{OP}$ (typical), 22°C)

Parameter	C30642			C30665			Units
	Min	Typ	Max	Min	Typ	Max	
Active Diameter		2.0			3.0		mm
Responsivity At 850 nm	0.10	0.20		0.10	0.20		A/W
At 1300 nm	0.80	0.90		0.80	0.90		A/W
At 1550 nm	0.85	0.95		0.85	0.95		A/W
Shunt Resistance ($V_R = 10$ mV) ¹	2	25		1	10		MΩ
Dark Current		10^3			25^3		nA
Spectral Noise Current (10 kHz, 1.0 Hz)		0.03	0.15		0.04	0.20	pA/√Hz
Capacitance At $V_R = 0$ V		300	500		1000	1250	pF
At $V_R = 2.0$ V (typical)		150			400		pF
Bandwidth (-3 dB, $R_L = 50\Omega$)		20			3.0		MHz
Linearity ²		+11			+11		dBm
Available package types		D15			D15		-

Operating Ratings

Parameter	C30642			C30665			Units
	Min	Typ	Max	Min	Typ	Max	
Operating Voltage		0	5		0	5	V
Breakdown Voltage	15	50		10	50		V
Maximum Forward Current			10			10	mA
Maximum Photocurrent			100			100	mA
Power Dissipation			250			250	mW
Storage Temperature	-60		125	-80		125	°C
Operating Temperature	-40		85	-40		85	°C

Note 1. Selected higher shunt resistance devices are available to special order.

Note 2. Maximum optical power level for ± 0.04 dB ($\pm 1\%$) responsivity variation under 1300 nm CW illumination, at $V_R = V_{OP}$ (typ).

Note 3. At $V_R = 2.0$ V

Package Options

TE-Cooled Devices: Large-area detectors are available mounted on a 1-stage or 2-stage thermoelectric (TE) cooler. Cooling increases shunt resistance (see Figure 2) thereby reducing noise for increased sensitivity. Typical detector temperature is -10°C with a 1-stage TE cooler or -35°C using a 2-stage cooler. A TE-cooler option can be specified by adding the extension -TC (1-stage cooler) or -DTC (2-stage cooler) to the standard part number (see ordering guide). More information is available from the "TC-Series Cooled Photodiodes" datasheet from PerkinElmer Optoelectronics Canada.

Detector and Pre-Amplifier: Large-area InGaAs detectors are also available integrated with a preamplifier and TE-cooler. The HTE-series features large-area InGaAs detectors with a high gain hybrid transimpedance amplifier mounted on a 2-stage TE cooler. TE-cooling maximizes sensitivity and stabilizes op-amp offset and output characteristics. This provides an easy-to-use high sensitivity detector platform optimized for good temperature stability over a wide operating temperature range. More information is available from the HTE-series datasheet. The standard HTE-2642 incorporates a C30642E chip.

Specifications (at $V_R = V_{OP}$ (typical), 22°C)

Parameter	C30619			C30641			Units
	Min	Typ	Max	Min	Typ	Max	
Active Diameter		0.5			1.0		mm
Responsivity At 850 nm	0.10	0.20		0.10	0.20		A/W
At 1300 nm	0.80	0.90		0.80	0.90		A/W
At 1550 nm	0.85	0.95		0.85	0.95		A/W
Shunt Resistance ($V_R = 10\text{ mV}$) ¹	10	250		5	50		M Ω
Dark Current		1	20		5	50	nA
Spectral Noise Current (10 kHz, 1.0 Hz)		0.02	0.10		0.04	0.15	pA/ $\sqrt{\text{Hz}}$
Capacitance At $V_R = 0\text{V}$		20	25		100	125	pF
At $V_R = V_{OP}$		8	10		40	50	pF
Bandwidth (-3 dB, $R_L = 50\Omega$)		350			75		MHz
Linearity ²		> +13			> +13		dBm
Available package types		D2, D14			D2, D14		-

Operating Ratings

Parameter	C30619			C30641			Units
	Min	Typ	Max	Min	Typ	Max	
Operating Voltage	0	5	10	0	2	5	V
Breakdown Voltage	20	80		20	80		V
Maximum Forward Current			10			10	mA
Maximum Photocurrent			100			100	mA
Power Dissipation			100			100	mW
Storage Temperature	-60		125	-80		125	$^{\circ}\text{C}$
Operating Temperature	-40		85	-40		85	$^{\circ}\text{C}$

Note 1. Selected higher shunt resistance devices are available to special order.

Note 2. Maximum optical power level for $\pm 0.04\text{ dB}$ ($\pm 1\%$) responsivity variation under 1300 nm CW illumination, at $V_R = V_{OP}$ (typ).



EVERYTHING

IN A

NEW

LIGHT.

Description

The PerkinElmer family of large-area InGaAs PIN photodiodes provide high responsivity from 800 nm to 1700 nm for applications including optical power meters, fiber optic test equipment, near-IR spectroscopy and instrumentation. All devices are planar passivated and feature low capacitance for extended bandwidth, and high shunt resistance for maximum sensitivity. Typical devices feature <1% non-linearity to optical powers $>+13$ dBm (20 mW), and uniformity within $\pm 2\%$ across the detector active area. Typical responsivity of 0.2 A/W at 850 nm for our large-area InGaAs devices allows use of a single detector in fiber optic test instrumentation designed to operate at 850, 1300, and 1550 nm.

Devices are available with active areas from 0.5 mm to 3.0 mm in TO-type packages or on thermoelectric coolers for increased sensitivity (see below). Photodiodes can also be mounted on customized ceramic sub-mounts to suit specific application requirements.

PerkinElmer Optoelectronics Canada is qualified to ISO-9001 and operates to MIL-Q-9858A and AQAP-1 quality standards. All devices undergo extended life-test and periodic process qualification programs to assure high reliability. In addition, all production devices are sourced from a qualified wafer, screened with a 16 hour, 200°C burn-in at -10V bias (C30619 and C30641) or -5V (C30642 and C30665), and tested to meet responsivity, spectral noise, capacitance, shunt resistance and dark current specifications.

Large-Area InGaAs Photodiodes

C30619, C30641, C30642, C30665

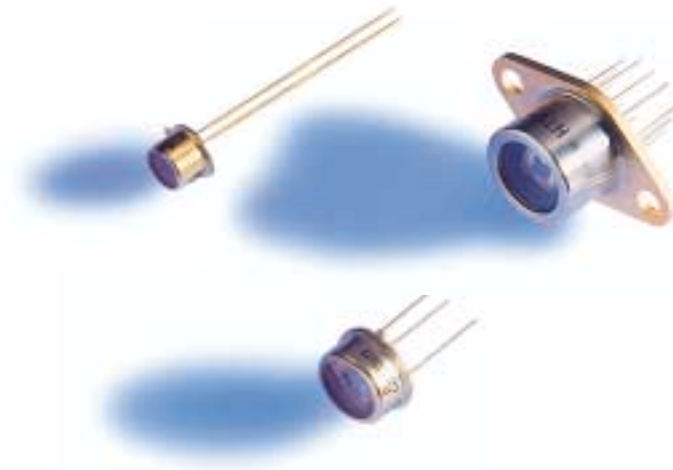

Features

- 0.5, 1.0, 2.0, and 3.0 mm diameters
- High responsivity from 850 nm to 1550 nm
- High shunt resistance, low dark current
- TE-cooled package options
- Low capacitance for fast response times

Applications

- Power meters
- Fiber identifiers
- Laser burn-in racks
- Near infrared instrumentation
- F.T.I.R. spectroscopy