

Silicon NPN Power Transistors

2SC3832

DESCRIPTION

- With TO-220C package
- High voltage
- High speed switching

APPLICATIONS

- For switching regulator and general purpose applications

PINNING

PIN	DESCRIPTION
1	Base
2	Collector;connected to mounting base
3	Emitter

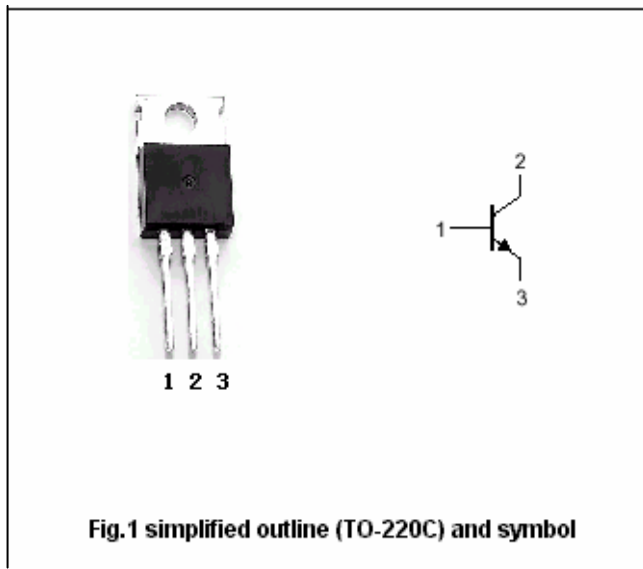

Fig.1 simplified outline (TO-220C) and symbol

Absolute maximum ratings(Ta=25°C)

SYMBOL	PARAMETER	CONDITIONS	VALUE	UNIT
V _{CBO}	Collector-base voltage	Open emitter	500	V
V _{CEO}	Collector-emitter voltage	Open base	400	V
V _{EBO}	Emitter-base voltage	Open collector	10	V
I _C	Collector current		7	A
I _{CM}	Collector current-peak		14	A
I _B	Base current		2	A
P _C	Collector dissipation	T _C =25°C	50	W
T _j	Junction temperature		150	°C
T _{stg}	Storage temperature		-55~150	°C

Silicon NPN Power Transistors

2SC3832

CHARACTERISTICS

T_j=25 °C unless otherwise specified

SYMBOL	PARAMETER	CONDITIONS	MIN	TYP.	MAX	UNIT
V _{(BR)CEO}	Collector-emitter breakdown voltage	I _C =25mA ; I _B =0	400			V
V _{CEsat}	Collector-emitter saturation voltage	I _C =3A; I _B =0.6A			0.5	V
V _{BEsat}	Base-emitter saturation voltage	I _C =3A; I _B =0.6A			1.3	V
I _{CBO}	Collector cut-off current	V _{CB} =500V ; I _E =0			100	μA
I _{EBO}	Emitter cut-off current	V _{EB} =10V; I _C =0			100	μA
h _{FE}	DC current gain	I _C =3A ; V _{CE} =4V	10		30	
f _T	Transition frequency	I _C =0.5A ; V _{CE} =12V		10		MHz
C _{OB}	Output capacitance	f=1MHz ; V _{CB} =10V		50		pF

Switching times

t _{on}	Turn-on time	V _{CC} =200V; I _C =3A I _{B1} =0.3A; I _{B2} =-0.6A; R _L =66.7Ω			1.0	μs
t _{stg}	Storage time				3.0	μs
t _f	Fall time				0.5	μs

Silicon NPN Power Transistors

2SC3832

PACKAGE OUTLINE

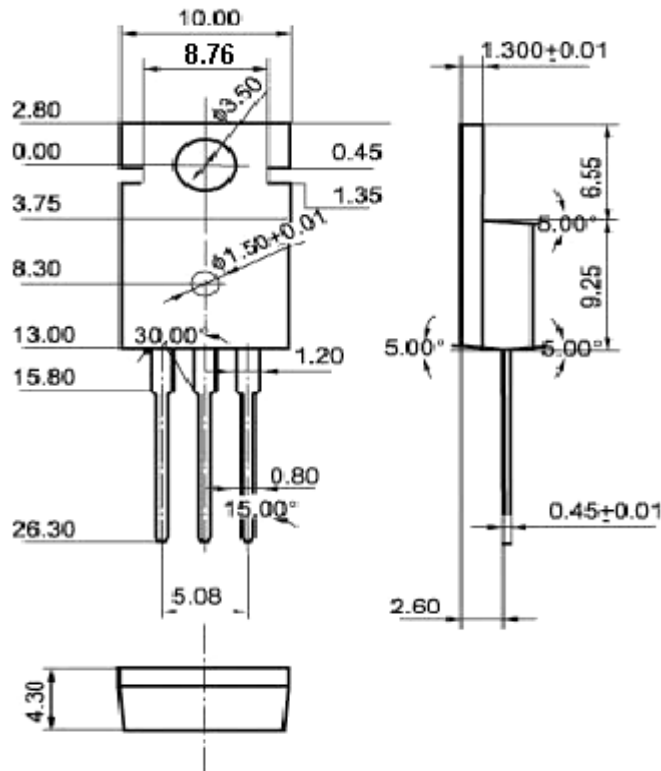

Fig.2 Outline dimensions (unindicated tolerance:±0.10 mm)

Silicon NPN Power Transistors

2SC3832

www.DataSheet4U.com

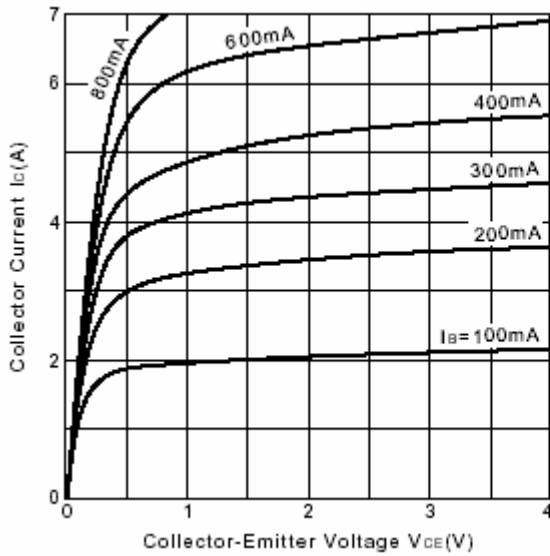

Fig.3 Static Characteristic

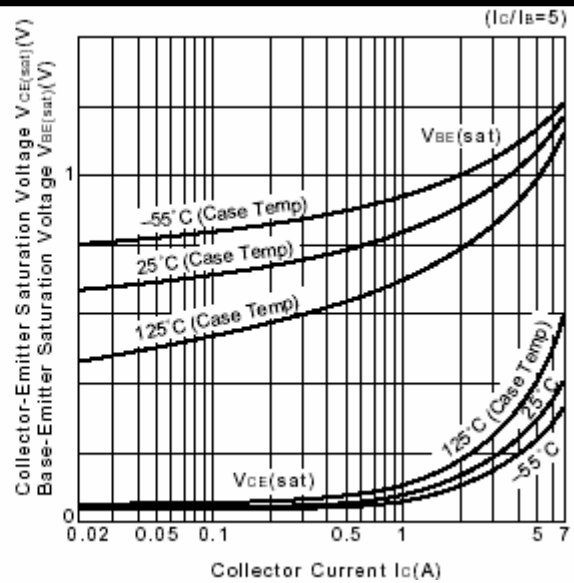

Fig.4 Base-Emitter Saturation Voltage
Collector-Emitter Saturation Voltage

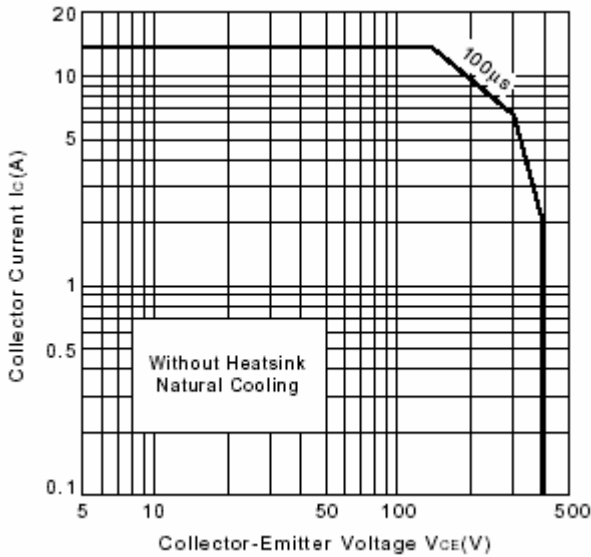

Fig.5 Safe Operating Area

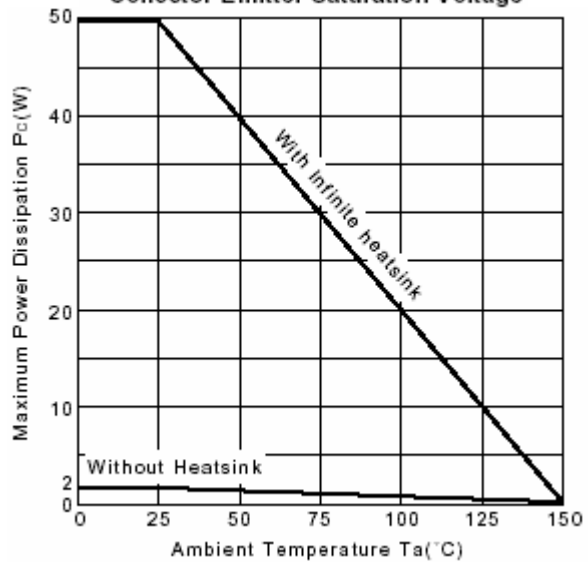

Fig.6 Power Derating

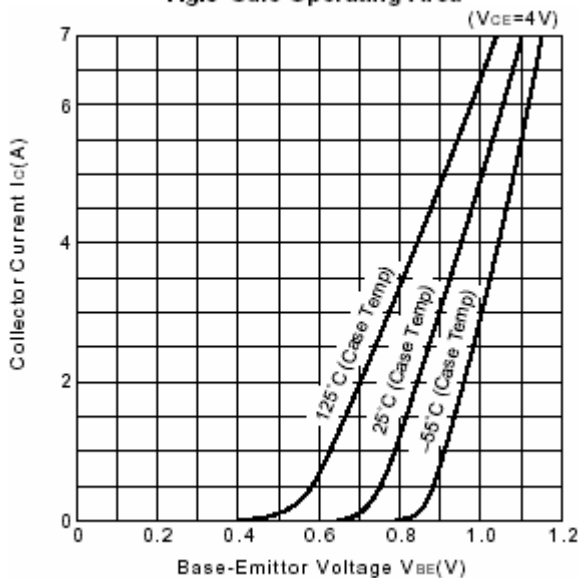

Fig.7 I_c-V_{BE}

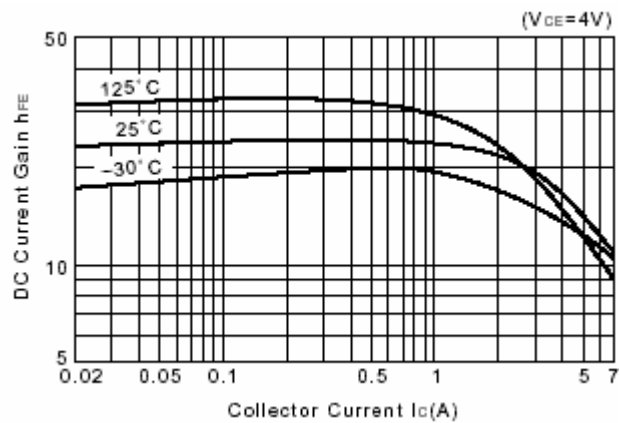

Fig.8 DC current Gain