

2SC3973, 2SC3973A

Silicon NPN triple diffusion planar type

For high breakdown voltage high-speed switching

■ Features

- High-speed switching
- High collector to base voltage V_{CBO}
- Wide area of safe operation (ASO)
- Satisfactory linearity of forward current transfer ratio h_{FE}
- Full-pack package which can be installed to the heat sink with one screw

■ Absolute Maximum Ratings ($T_C=25^\circ\text{C}$)

Parameter	Symbol	Rated	Unit
Collector to base voltage	V_{CBO}	800	V
		900	V
Collector to emitter voltage	V_{CES}	800	V
		900	V
Collector to emitter voltage	V_{CEO}	500	V
Emitter to base voltage	V_{EBO}	8	V
Peak collector current	I_{CP}	15	A
Collector current	I_C	7	A
Base current	I_B	4	A
Collector power dissipation	P_C	45	W
		2	W
Junction temperature	T_j	150	$^\circ\text{C}$
Storage temperature	T_{stg}	-55 to +150	$^\circ\text{C}$

■ Electrical Characteristics ($T_C=25^\circ\text{C}$)

Parameter	Symbol	Conditions	min	typ	max	Unit
Collector cutoff current	I_{CBO}	$V_{CB} = 800\text{V}, I_E = 0$			100	μA
		$V_{CB} = 900\text{V}, I_E = 0$			100	μA
Emitter cutoff current	I_{EBO}	$V_{EB} = 5\text{V}, I_C = 0$			100	μA
Collector to emitter voltage	V_{CEO}	$I_C = 10\text{mA}, I_B = 0$	500			V
Forward current transfer ratio	h_{FE1}	$V_{CE} = 5\text{V}, I_C = 0.1\text{A}$	15			
	h_{FE2}	$V_{CE} = 5\text{V}, I_C = 4\text{A}$	8			
Collector to emitter saturation voltage	$V_{CE(sat)}$	$I_C = 4\text{A}, I_B = 0.8\text{A}$			1.0	V
Base to emitter saturation voltage	$V_{BE(sat)}$	$I_C = 4\text{A}, I_B = 0.8\text{A}$			1.5	V
Transition frequency	f_T	$V_{CE} = 10\text{V}, I_C = 0.5\text{A}, f = 1\text{MHz}$		20		MHz
Turn-on time	t_{on}	$I_C = 4\text{A}, I_{B1} = 0.8\text{A}, I_{B2} = -1.6\text{A}, V_{CC} = 200\text{V}$			1.0	μs
Storage time	t_{stg}				3.0	μs
Fall time	t_f				0.3	μs

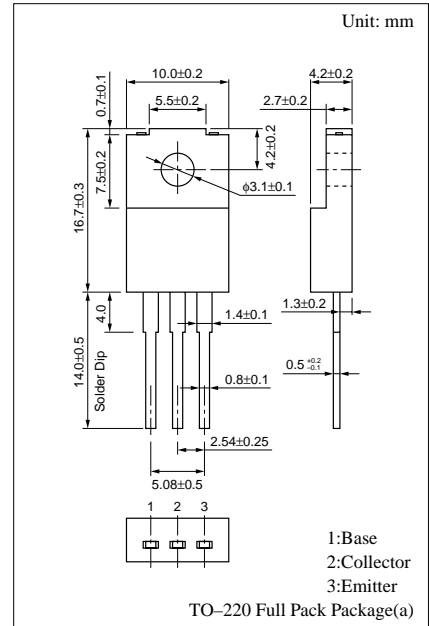

$P_C - T_a$

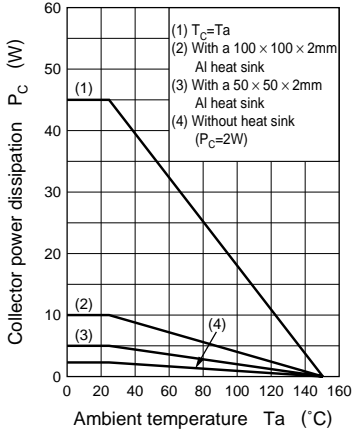

$I_C - V_{CE}$

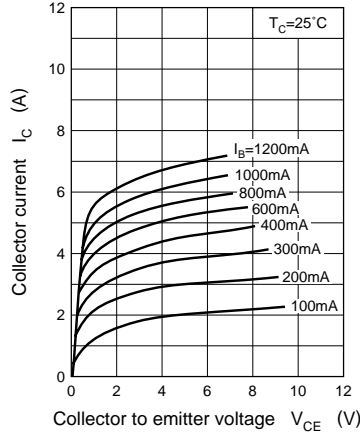

$V_{CE(sat)} - I_C$

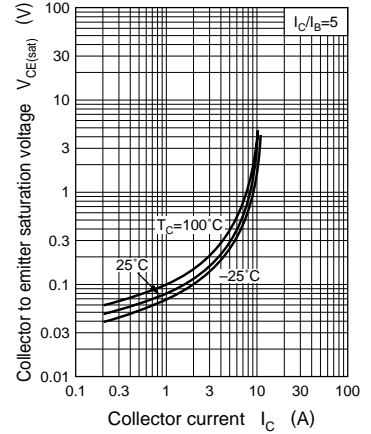

$V_{BE(sat)} - I_C$

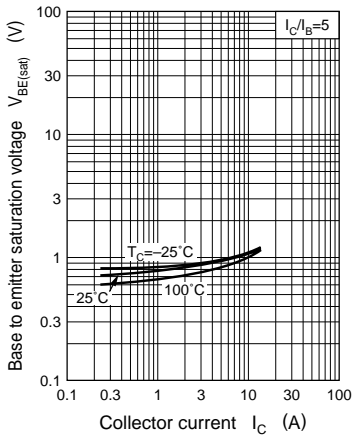

$h_{FE} - I_C$

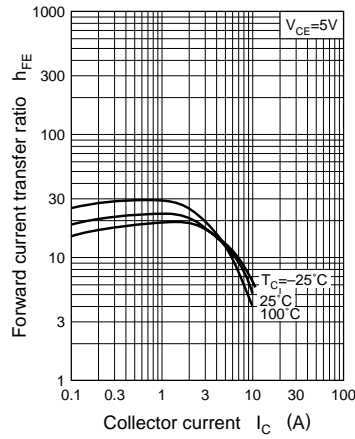

$f_T - I_C$

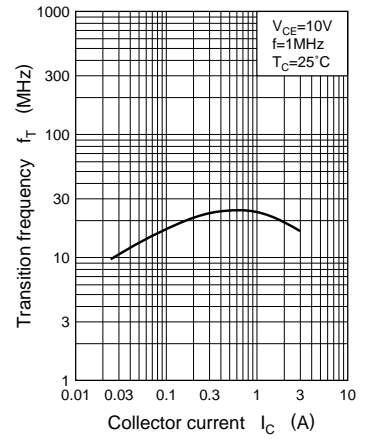

$C_{ob} - V_{CB}$

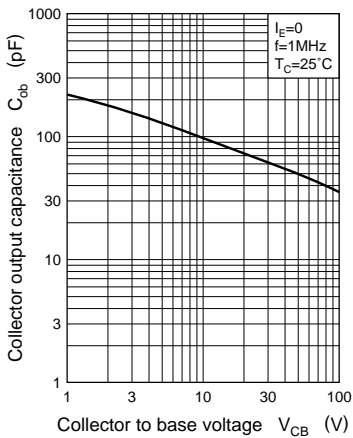

$t_{on}, t_{stg}, t_f - I_C$

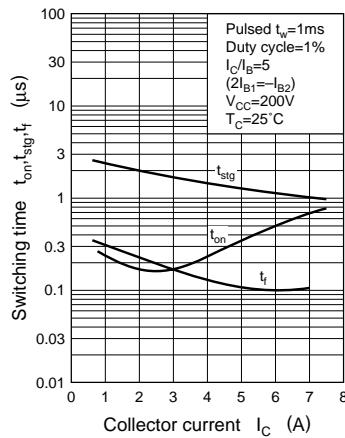

Area of safe operation (ASO)

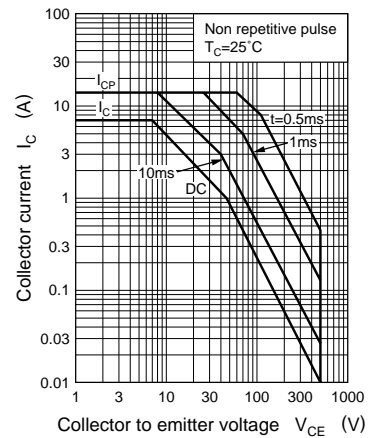

Area of safe operation, reverse bias ASO

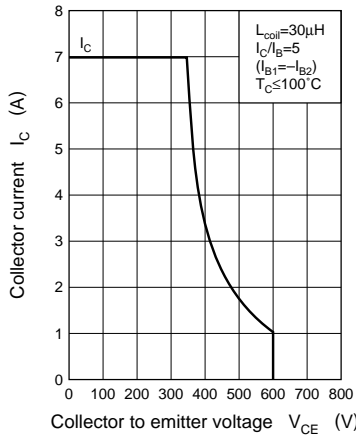

Reverse bias ASO measuring circuit

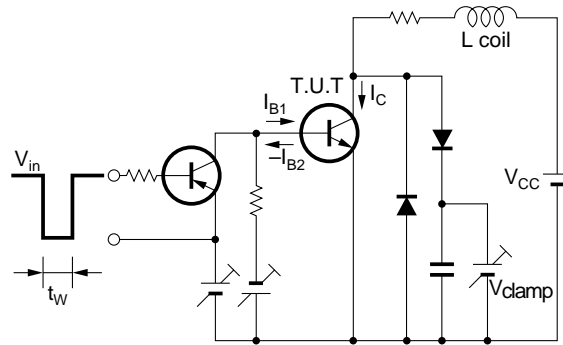

$R_{th(t)} - t$

