

C3D16065D1

3rd Generation 650 V, 16 A Silicon Carbide Schottky Diode

Description

With the performance advantages of a Silicon Carbide (SiC) Schottky Barrier diode, power electronics systems can expect to meet higher efficiency standards than Si-based solutions, while also reaching higher frequencies and power densities. SiC diodes can be easily paralleled to meet various application demands, without concern of thermal runaway. In combination with the reduced cooling requirements and improved thermal performance of SiC products, SiC diodes are able to provide lower overall system costs in a variety of diverse applications.

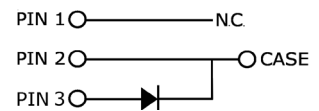
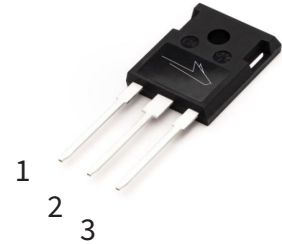

Package Types: TO-247-3
Marking: C3D16065D1

Features

- Low Forward Voltage (V_F) Drop with Positive Temperature Coefficient
- Zero Reverse Recovery Current / Forward Recovery Voltage
- Temperature-Independent Switching Behavior
- Low Leakage Current (I_R)

Typical Applications

- Industrial Power Supplies
- Battery Charging Systems
- Switch Mode Power Supplies
- AC/DC Converters
- Server/Telecom Power Supplies

Maximum Ratings ($T_c = 25^\circ\text{C}$ Unless Otherwise Specified)

Parameter	Symbol	Value	Unit	Test Conditions	Notes
Repetitive Peak Reverse Voltage	V_{RRM}	650	V		
DC Blocking Voltage	V_{DC}	650			
Continuous Forward Current	I_F	43	A	$T_J = 25^\circ\text{C}$	Fig. 3
		20		$T_J = 135^\circ\text{C}$	
		16		$T_J = 147^\circ\text{C}$	
Repetitive Peak Forward Surge Current	I_{FRM}	57	A	$T_c = 25^\circ\text{C}, t_p = 10\text{ ms}, \text{Half Sine Wave}$	
		33		$T_c = 110^\circ\text{C}, t_p = 10\text{ ms}, \text{Half Sine Wave}$	
Non-Repetitive Peak Forward Surge Current	I_{FSM}	160	A	$T_c = 25^\circ\text{C}, t_p = 10\text{ ms}, \text{Half Sine Wave}$	Fig. 8
		148		$T_c = 110^\circ\text{C}, t_p = 10\text{ ms}, \text{Half Sine Wave}$	
Power Dissipation	P_{tot}	173	W	$T_J = 25^\circ\text{C}$	Fig. 4
		75		$T_J = 110^\circ\text{C}$	
i ² t value	j ² dt	128	A ² s	$T_c = 25\text{C}, t_p = 10\text{ms}$	
		110		$T_c = 110\text{C}, t_p = 10\text{ms}$	

Electrical Characteristics

Parameter	Symbol	Typ.	Max.	Unit	Test Conditions	Notes
Forward Voltage	V_F	1.5	1.8	V	$I_F = 16 \text{ A}, T_j = 25 \text{ }^\circ\text{C}$	Fig. 1
		2.0	2.4		$I_F = 16 \text{ A}, T_j = 175 \text{ }^\circ\text{C}$	
Reverse Current	I_R	18	95	μA	$V_R = 650 \text{ V}, T_j = 25 \text{ }^\circ\text{C}$	Fig. 2
		38	378		$V_R = 650 \text{ V}, T_j = 175 \text{ }^\circ\text{C}$	
Total Capacitive Charge	Q_C	40		nC	$V_R = 400 \text{ V}, T_j = 25 \text{ }^\circ\text{C}, I_F = 16 \text{ A}$	Fig. 5
Total Capacitance	C	740		pF	$V_R = 0 \text{ V}, T_j = 25 \text{ }^\circ\text{C}, f = 1 \text{ MHz}$	Fig. 6
		74			$V_R = 200 \text{ V}, T_j = 25 \text{ }^\circ\text{C}, f = 1 \text{ MHz}$	
		68			$V_R = 400 \text{ V}, T_j = 25 \text{ }^\circ\text{C}, f = 1 \text{ MHz}$	
Capacitance Stored Energy	E_C	6		μJ	$V_R = 400 \text{ V}$	Fig. 7

Notes:

SIC Schottky Diodes are majority carrier devices, so there is no reverse recovery charge.

Thermal & Mechanical Characteristics

Parameter	Symbol	Value	Unit	Notes
Thermal Resistance, Junction to Case (Typical)	$R_{\theta, JC (TYP)}$	0.86	$^\circ\text{C} / \text{W}$	
Junction Temperature	T_j	-55 to +175	$^\circ\text{C}$	
Case & Storage Temperature	T_c	-55 to +175		
TO-247 Mounting Torque	-	1	Nm	M3 Screw
		8.8	lbf-in	6-32 Screw

Electrostatic Discharge (ESD) Classifications

Parameter	Symbol	Notes
Human Body Model	HBM	Class 3B ($\geq 8000 \text{ V}$)
Charge Device Model	CDM	Class C3 ($\geq 1000 \text{ V}$)

Typical Performance

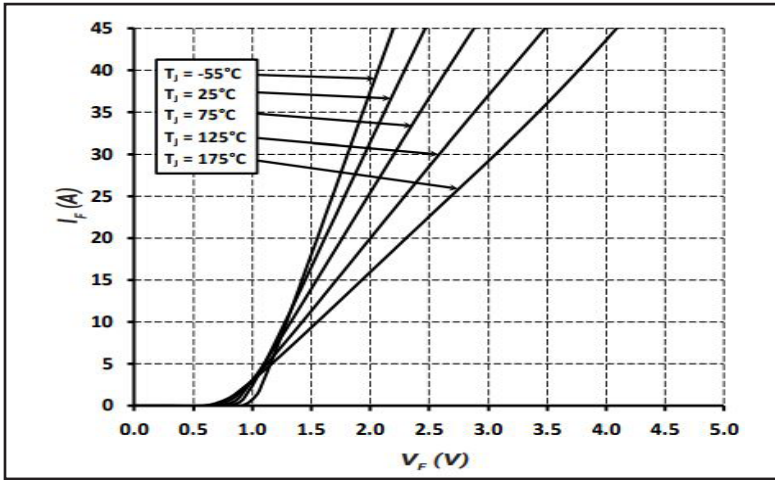

Figure 1

Forward Characteristics

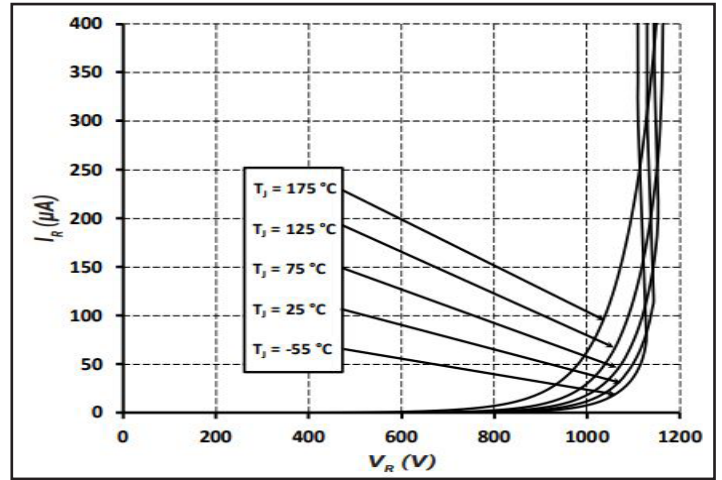

Figure 2

Reverse Characteristics

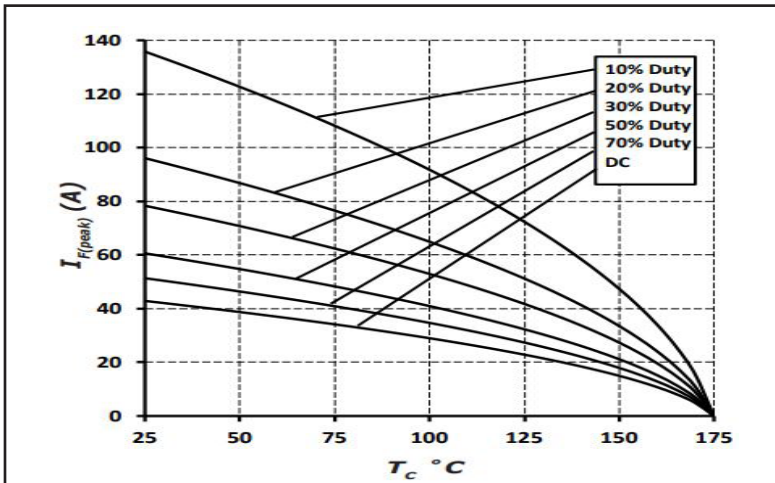

Figure 3

Current Derating

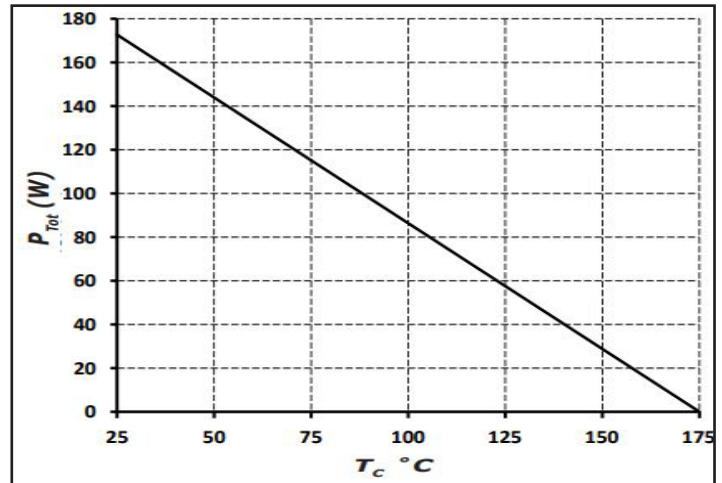

Figure 4

Power Derating

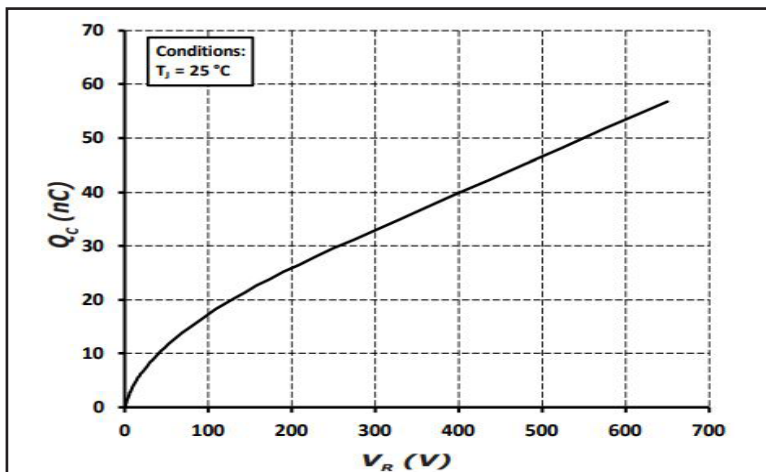

Figure 5

Total Capacitance Charge vs. Reverse Voltage

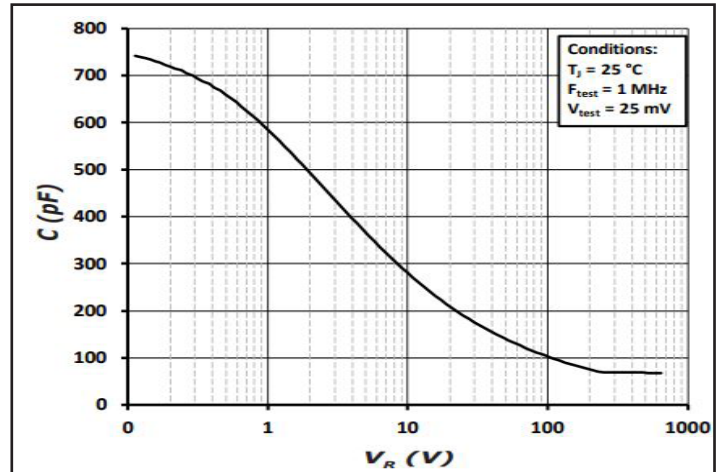

Figure 6

Capacitance vs. Reverse Voltage

Typical Performance

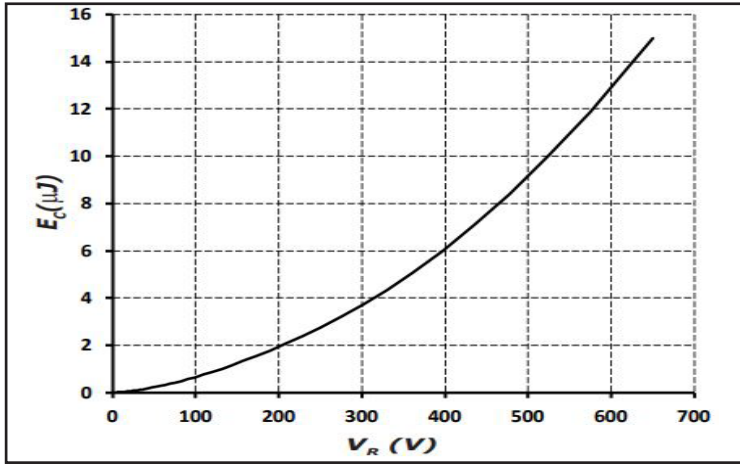

Figure 7

Capacitance Stored Energy

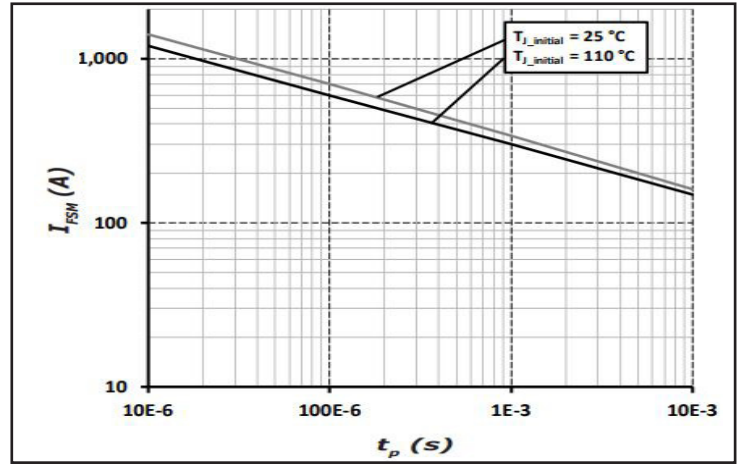

Figure 8

Non-Repetitive Peak Forward Surge Current vs. Pulse Duration

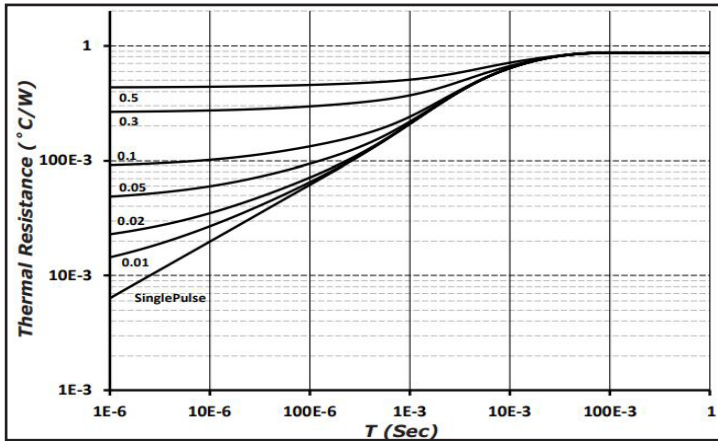
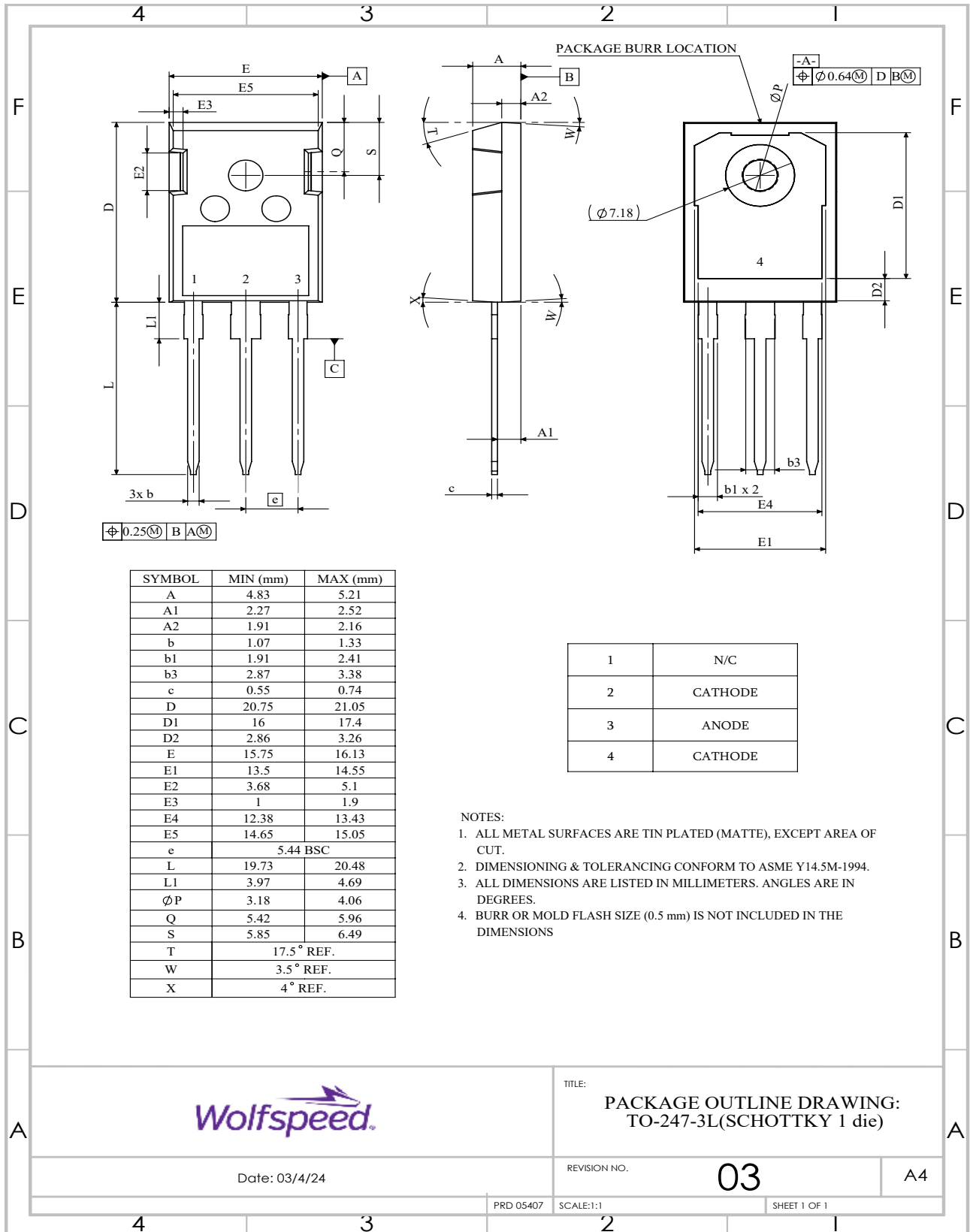

Figure 9

Transient Thermal Impedance

Package Dimensions & Pin-Out

Package: TO-247-3



TITLE: PACKAGE OUTLINE DRAWING:
TO-247-3L(SCHOTTKY 1 die)

Date: 03/4/24

REVISION NO.

03

A4

PRD 05407

SCALE:1:1

SHEET 1 OF 1

Recommended Solder Pad Layout

Primary dimensions shown in mm.

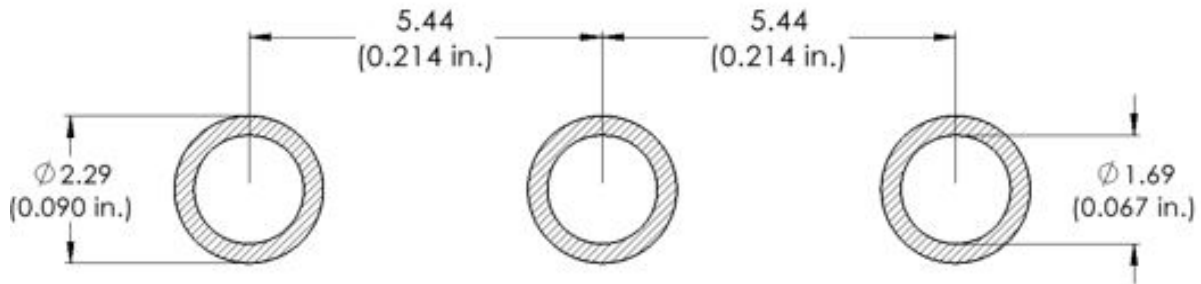

Diode Model

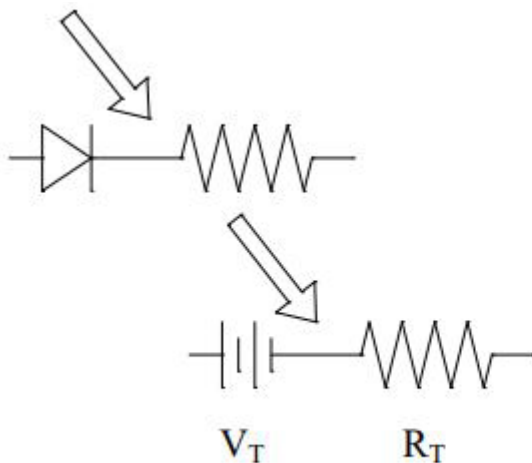

$$V_{fT} = V_T + I_f * R_T$$

$$V_T = 0.97 + (T_J * -1.0 * 10^{-3})$$

$$R_T = 0.024 + (T_J * 3.0 * 10^{-4})$$

Note: T_J = Diode Junction Temperature In Degrees Celsius, valid from 25°C to 175°C

Product Ordering Information

Order Number	Packing Type
C3D16065D1	Tube

REACH, RoHS, and Halogen-Free compliance documentation available for this product.



Revision History

Document Version	Date of Release	Description of Changes
0	August-2019	Initial Release
1	November-2023	Updated Branding, POD, Package Image, Solder Pad Layout
2	September - 2024	Legal Disclaimer and POD Updated

Notes & Disclaimer

WOLFSPEED PROVIDES TECHNICAL AND RELIABILITY DATA, DESIGN RESOURCES, APPLICATION OR OTHER DESIGN ADVICE, WEB TOOLS, AND OTHER RESOURCES “AS IS” AND WITH ALL FAULTS, AND DISCLAIMS ALL WARRANTIES, EXPRESS AND IMPLIED, WITH RESPECT THERETO, INCLUDING WITHOUT LIMITATION ANY IMPLIED WARRANTIES OF MERCHANTABILITY, SUITABILITY, FITNESS FOR A PARTICULAR PURPOSE, OR NON-INFRINGEMENT OF THIRD-PARTY INTELLECTUAL PROPERTY RIGHTS.

This document and the information contained herein are subject to change without notice. Any such change shall be evidenced by the publication of an updated version of this document by Wolfspeed. No communication from any employee or agent of Wolfspeed or any third party shall effect an amendment or modification of this document. No responsibility is assumed by Wolfspeed for any infringement of patents or other rights of third parties which may result from use of the information contained herein. No license is granted by implication or otherwise under any patent or patent rights of Wolfspeed.

The information contained in this document (excluding examples, as well as figures or values that are labeled as “typical”) constitutes Wolfspeed’s sole published specifications for the subject product. “Typical” parameters are the average values expected by Wolfspeed in large quantities and are provided for informational purposes only. Any examples provided herein have not been produced under conditions intended to replicate any specific end use. Product performance can and does vary due to a number of factors.

This product has not been designed or tested for use in, and is not intended for use in, any application in which failure of the product would reasonably be expected to cause death, personal injury, or property damage. For purposes of (but without limiting) the foregoing, this product is not designed, intended, or authorized for use as a critical component in equipment implanted into the human body, life-support machines, cardiac defibrillators, and similar emergency medical equipment; air traffic control systems; or equipment used in the planning, construction, maintenance, or operation of nuclear facilities. Notwithstanding any application-specific information, guidance, assistance, or support that Wolfspeed may provide, the buyer of this product is solely responsible for determining the suitability of this product for the buyer’s purposes, including without limitation (1) selecting the appropriate Wolfspeed products for the buyer’s application, (2) designing, validating, and testing the buyer’s application, and (3) ensuring the buyer’s application meets applicable standards and any other legal, regulatory, and safety-related requirements.

RoHS Compliance

The levels of RoHS restricted materials in this product are below the maximum concentration values (also referred to as the threshold limits) permitted for such substances, or are used in an exempted application, in accordance with EU Directive 2011/65/EC (RoHS2), as implemented January 2, 2013. RoHS Declarations for this product can be obtained from your Wolfspeed representative or from the Product Documentation sections of www.wolfspeed.com.

REACH Compliance

REACH substances of high concern (SVHCs) information is available for this product. Since the European Chemical Agency (ECHA) has published notice of their intent to frequently revise the SVHC listing for the foreseeable future, please contact your Wolfspeed representative to ensure you get the most up-to-date REACH SVHC Declaration. REACH banned substance information (REACH Article 67) is also available upon request.

Contact info:

4600 Silicon Drive
Durham, NC 27703 USA
Tel: +1.919.313.5300
www.wolfspeed.com/power

© 2024 Wolfspeed, Inc. All rights reserved. Wolfspeed® and the Wolfstreak logo are registered trademarks and the Wolfspeed logo is a trademark of Wolfspeed, Inc.
PATENT: <https://www.wolfspeed.com/legal/patents>

The information in this document is subject to change without notice.