

C3D1P7060Q

Silicon Carbide Schottky Diode

Z-REC[®] RECTIFIER

V_{RRM}	=	600 V
$I_F (T_c=135^\circ\text{C})$	=	3.3 A
Q_c	=	4 nC

Features

- 600-Volt Schottky Rectifier
- Optimized for PFC Boost Diode Application
- Zero Reverse Recovery Current
- High-Frequency Operation
- Temperature-Independent Switching Behavior
- Extremely Fast Switching
- Positive Temperature Coefficient on V_F

Benefits

- Small compact surface mount package
- Essentially No Switching Losses
- Higher Efficiency
- Reduction of Heat Sink Requirements
- Parallel Devices Without Thermal Runaway

Applications

- Switch Mode Power Supplies
- LED Lighting
- Medical imaging systems

Package

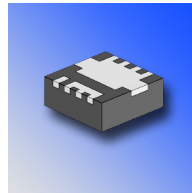

PowerQFN 3.3x3.3



Part Number	Package	Marking
C3D1P7060Q	QFN 3.3	C3D1P7060

Maximum Ratings ($T_c = 25^\circ\text{C}$ unless otherwise specified)

Symbol	Parameter	Value	Unit	Test Conditions	Note
V_{RRM}	Repetitive Peak Reverse Voltage	600	V		
V_{RSM}	Surge Peak Reverse Voltage	600	V		
V_{DC}	DC Blocking Voltage	600	V		
I_F	Continuous Forward Current	9.7 3.3 1.7	A	$T_c=25^\circ\text{C}$ $T_c=135^\circ\text{C}$ $T_c=150^\circ\text{C}$	Fig 3
I_{FRM}	Repetitive Peak Forward Surge Current	7 4.5	A	$T_c=25^\circ\text{C}, t_p = 10 \text{ ms}$, Half Sine Wave $T_c=110^\circ\text{C}, t_p = 10 \text{ ms}$, Half Sine Wave	
I_{FSM}	Non-Repetitive Peak Forward Surge Current	15 12	A	$T_c=25^\circ\text{C}, t_p = 10 \text{ ms}$, Half Sine Wave $T_c=110^\circ\text{C}, t_p = 10 \text{ ms}$, Half Sine Wave	Fig. 8
I_{FMax}	Non-Repetitive Peak Forward Surge Current	50 40		$T_c=25^\circ\text{C}, t_p = 10 \mu\text{s}$, Pulse $T_c=110^\circ\text{C}, t_p = 10 \mu\text{s}$, Pulse	Fig. 8
P_{tot}	Power Dissipation	35.5 13	W	$T_c=25^\circ\text{C}$ $T_c=110^\circ\text{C}$	Fig. 4
T_J, T_{stg}	Operating Junction and Storage Temperature	-55 to +160	$^\circ\text{C}$		

Electrical Characteristics

Symbol	Parameter	Typ.	Max.	Unit	Test Conditions	Note
V_F	Forward Voltage	1.5 1.7	1.7 2.4	V	$I_F = 1.7\text{ A}$ $T_C = 25^\circ\text{C}$ $I_F = 1.7\text{ A}$ $T_C = 150^\circ\text{C}$	Fig. 1
I_R	Reverse Current	3 6	15 55	μA	$V_R = 600\text{ V}$ $T_C = 25^\circ\text{C}$ $V_R = 600\text{ V}$ $T_C = 150^\circ\text{C}$	Fig. 2
Q_C	Total Capacitive Charge	4		nC	$V_R = 400\text{ V}$, $I_F = 1.7\text{ A}$ $di/dt = 500\text{ A}/\mu\text{s}$ $T_C = 25^\circ\text{C}$	Fig. 5
C	Total Capacitance	82.5 7 6		pF	$V_R = 0\text{ V}$, $T_C = 25^\circ\text{C}$, $f = 1\text{ MHz}$ $V_R = 200\text{ V}$, $T_C = 25^\circ\text{C}$, $f = 1\text{ MHz}$ $V_R = 400\text{ V}$, $T_C = 25^\circ\text{C}$, $f = 1\text{ MHz}$	Fig. 6
E_C	Capacitance Stored Energy	0.6		μJ	$V_R = 400\text{ V}$	Fig. 7

Note: This is a majority carrier diode, so there is no reverse recovery charge.

Thermal Characteristics

Symbol	Parameter	Typ.	Unit	Note
$R_{\theta JC}$	Thermal Resistance from Junction to Case	3.8	$^\circ\text{C}/\text{W}$	Fig. 9

Typical Performance

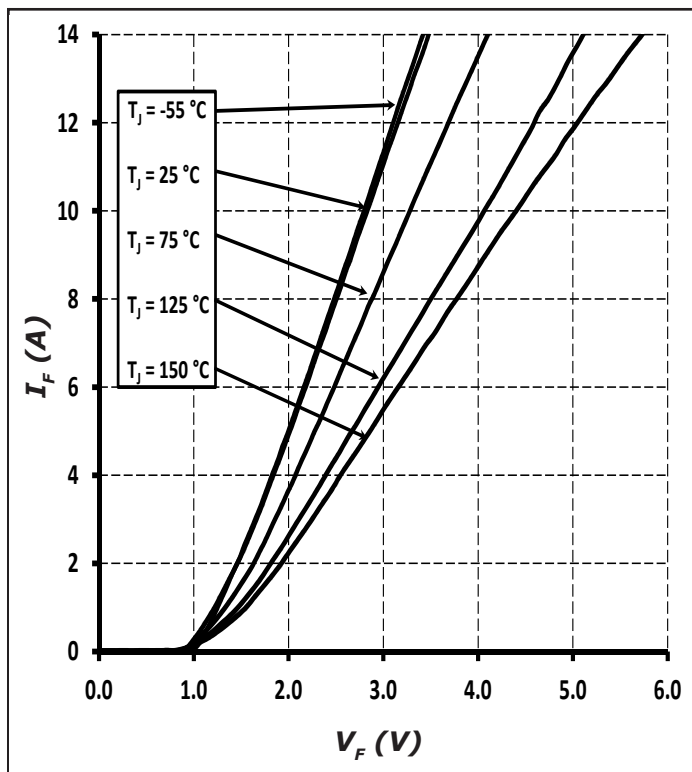

Figure 1. Forward Characteristics

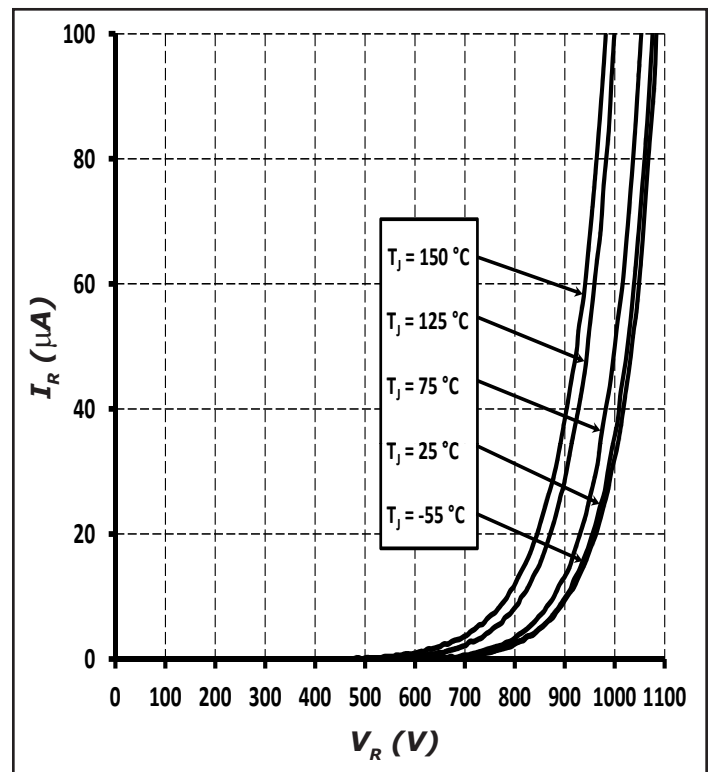

Figure 2. Reverse Characteristics

Typical Performance

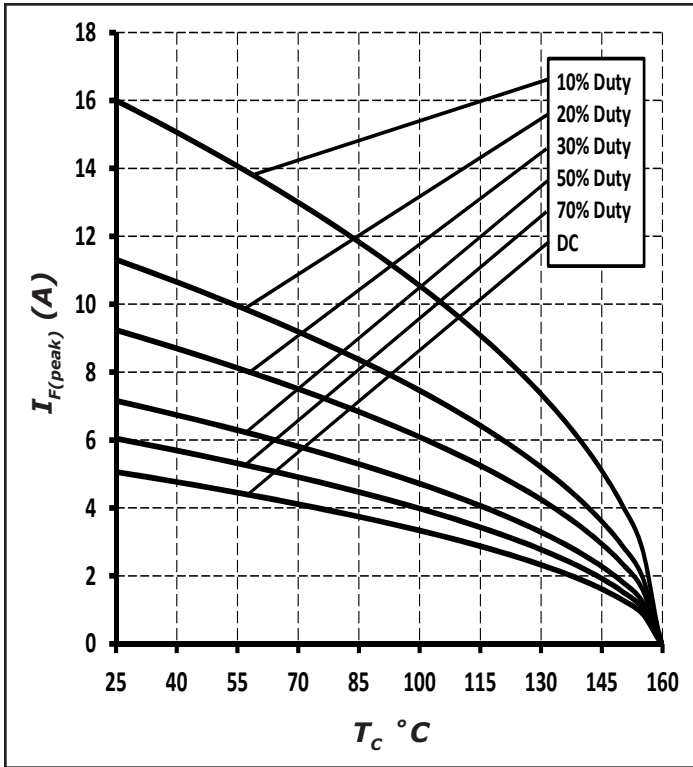

Figure 3. Current Derating

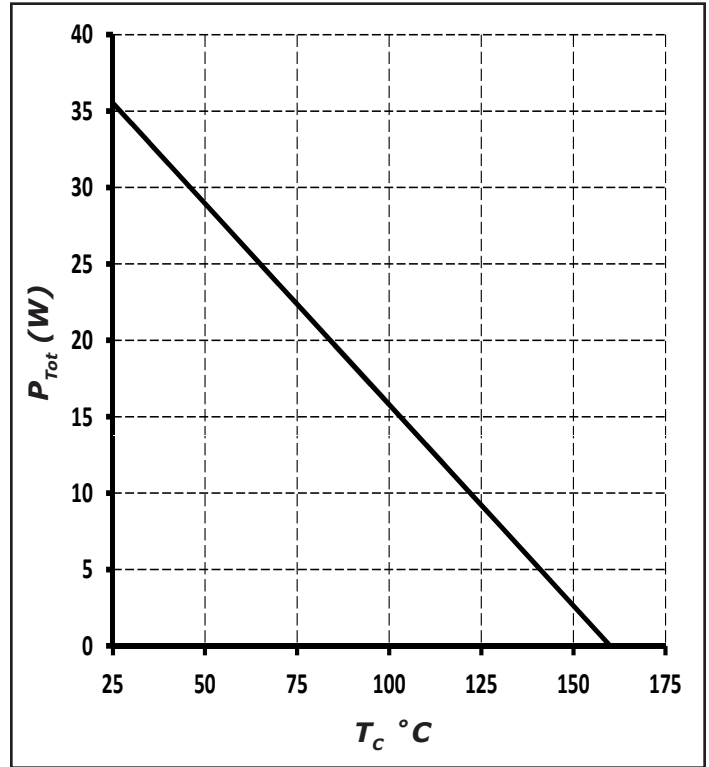

Figure 4. Power Derating

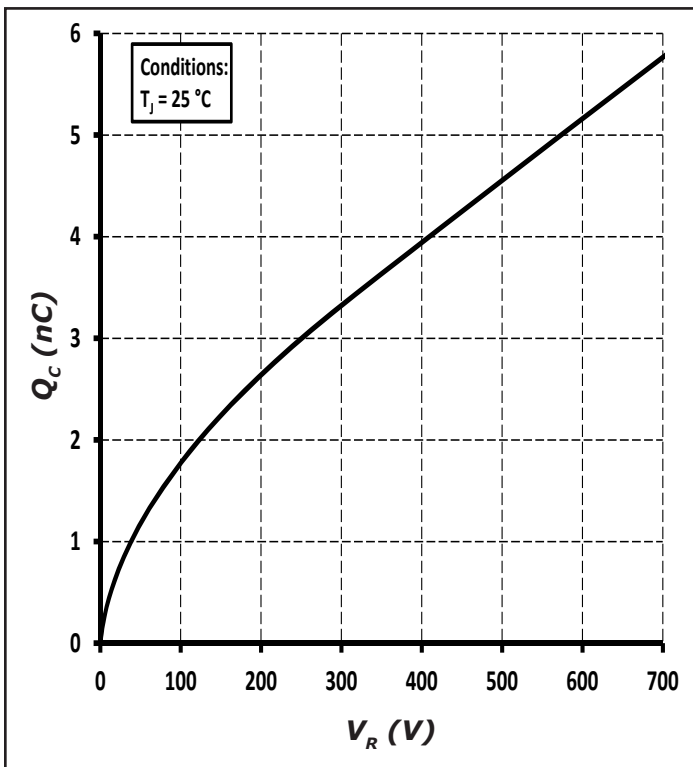

Figure 5. Total Capacitance Charge vs. Reverse Voltage

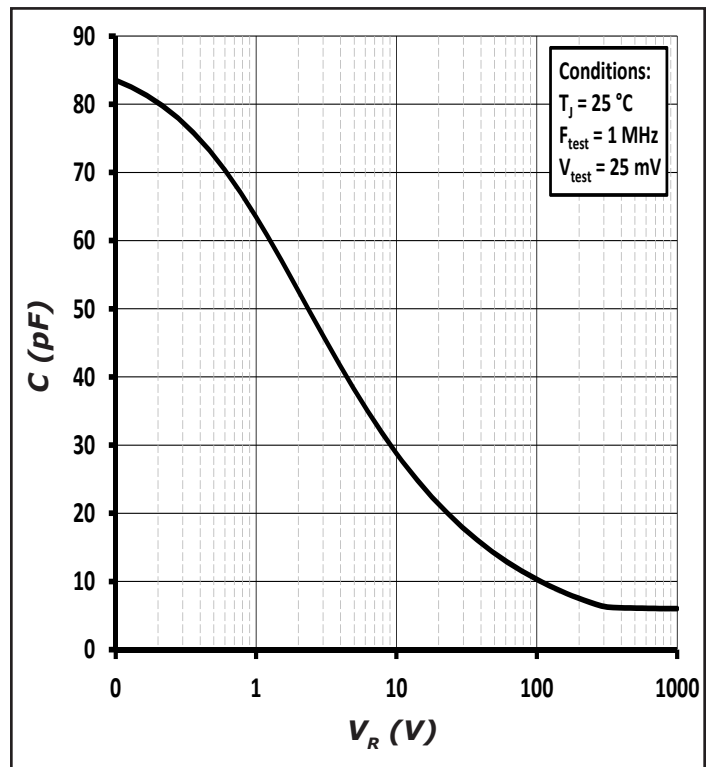

Figure 6. Capacitance vs. Reverse Voltage

Typical Performance

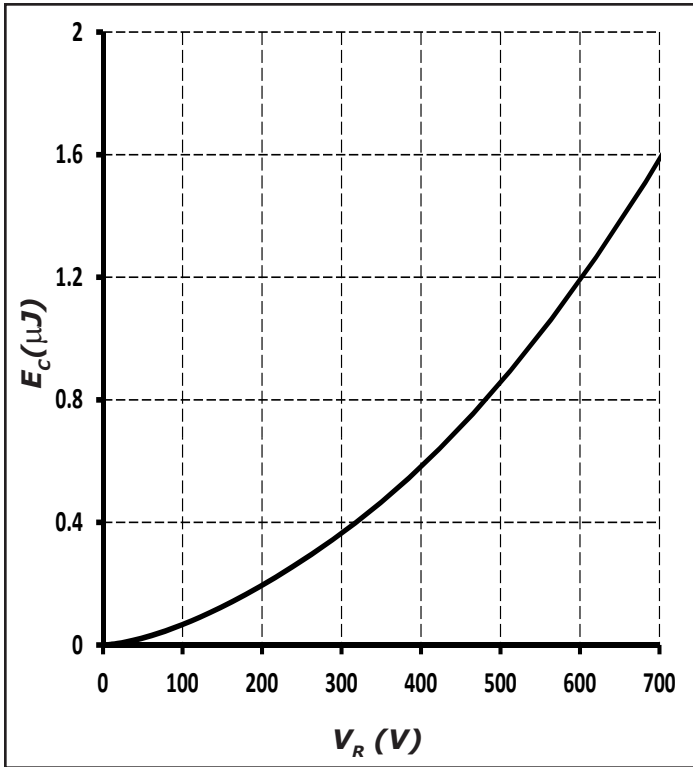

Figure 7. Capacitance Stored Energy

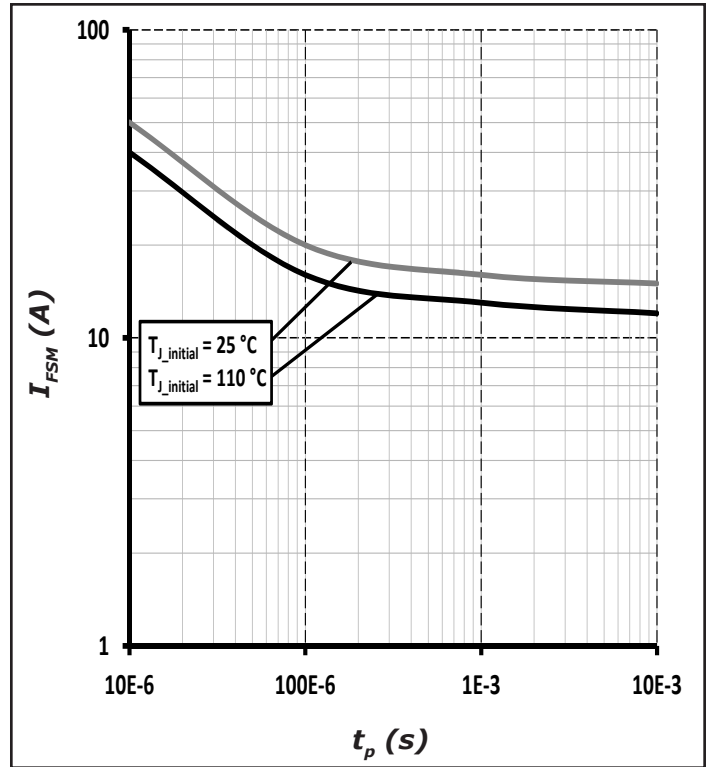

Figure 8. Non-repetitive peak forward surge current versus pulse duration (sinusoidal waveform)

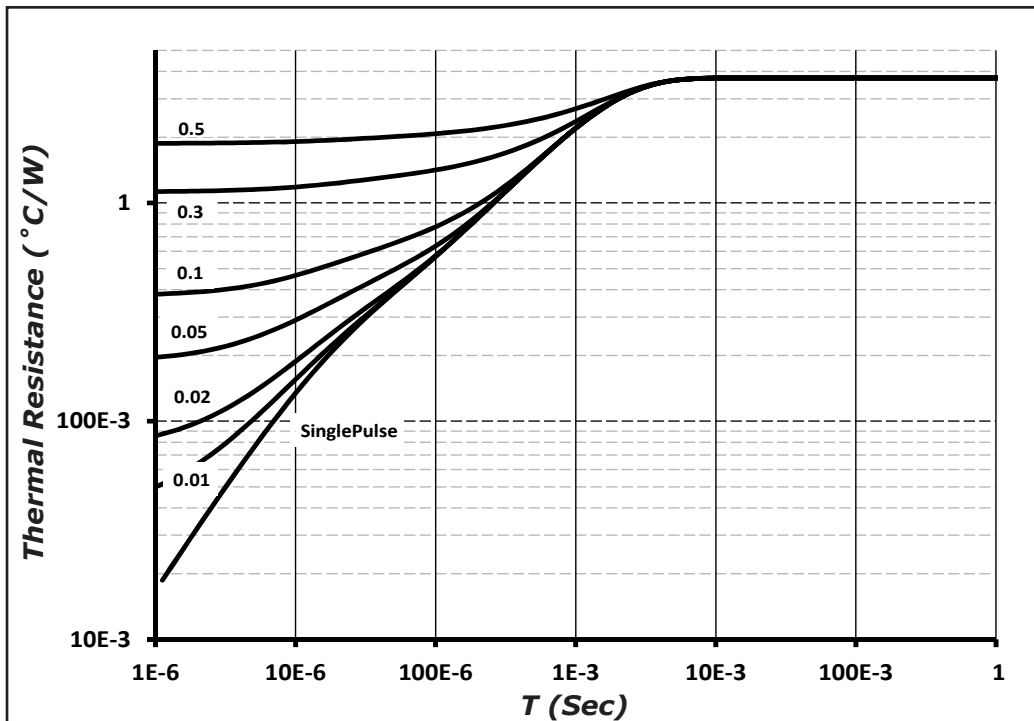
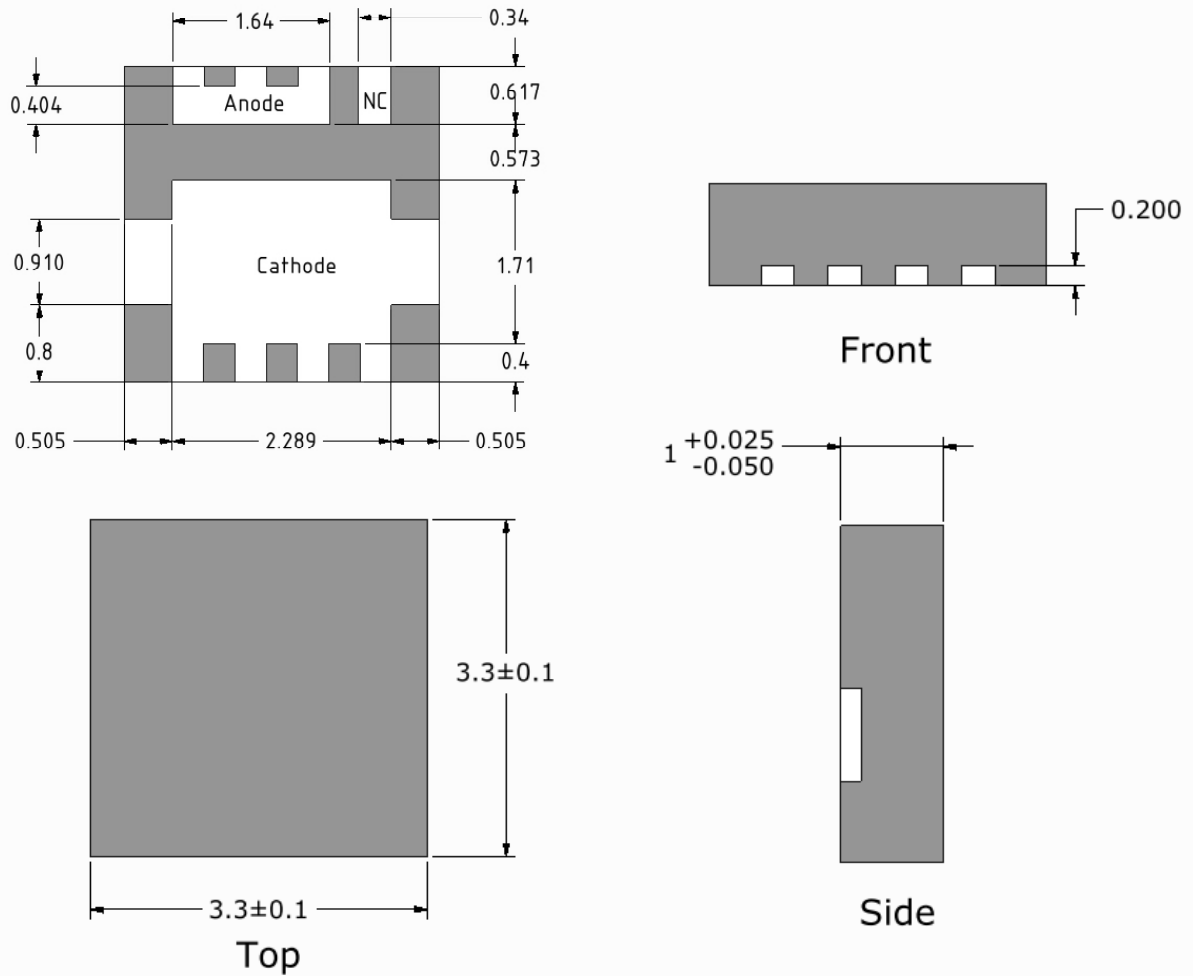

Figure 9. Transient Thermal Impedance

Package Dimensions

Package QFN 3.3



All Dimensions are in mm
Tolerances are 0.05 mm if not specified
NC = No Connect

Recommended Landing Pattern (All Dimensions are in mm)

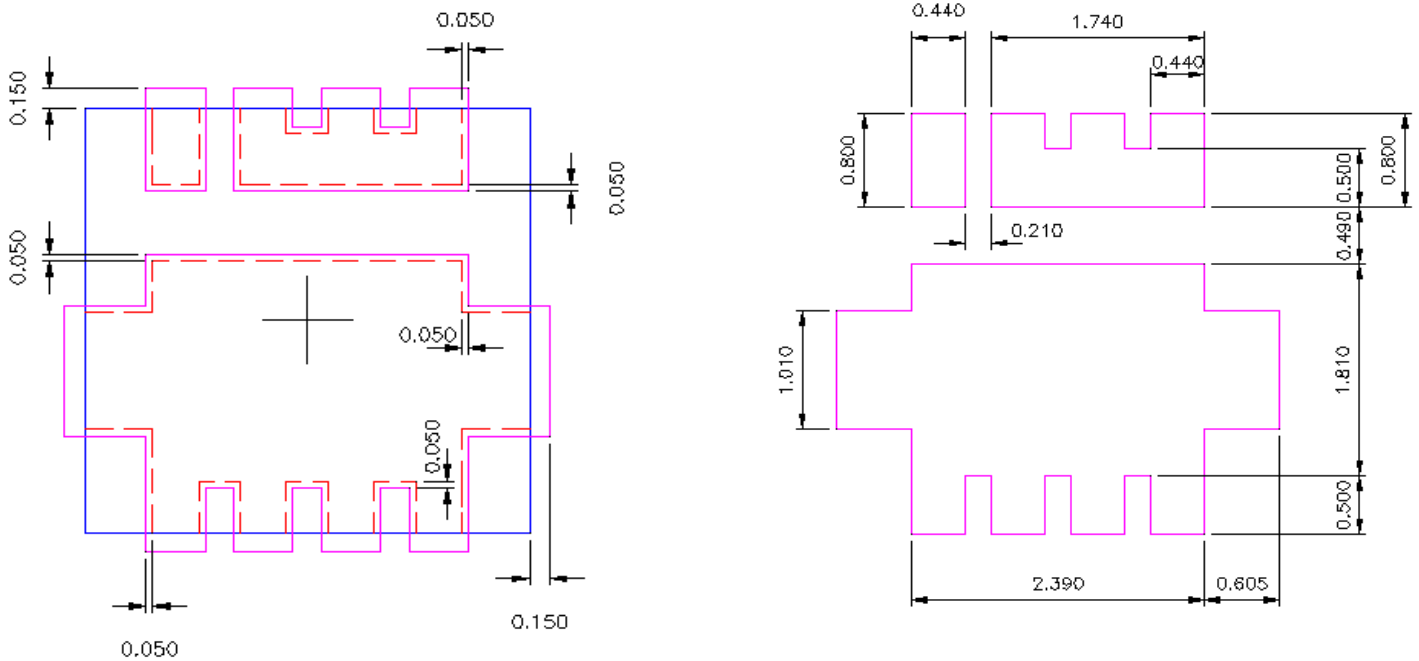

Note: The design of the land pattern and the size of the thermal pad depend mainly on the thermal characteristic and power dissipation. In general, the size of the thermal pad should be as close to the exposed pad of the package as possible, provided that there is no bridging between the thermal pad and the lead pads.

The 0.050mm extra length and width provides space to accommodate the placement tolerance of the component during pick and place process. The 0.150mm along the perimeter present areas for solder to form fillet along the side metal edges of the package.

Note: Recommended soldering profiles can be found in the applications note here:
http://www.wolfspeed.com/power_app_notes/soldering



Diode Model

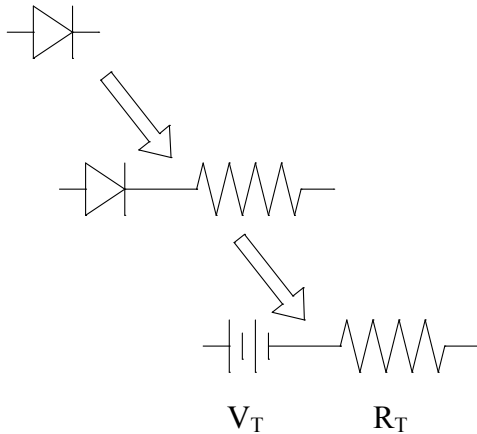

$$V_{fT} = V_T + I_f * R_T$$

$$V_T = 1.15 + (T_J * 1.1 * 10^{-3})$$

$$R_T = 0.13 + (T_J * 1.1 * 10^{-3})$$

Note: T_J = Diode Junction Temperature In Degrees Celsius, valid from 25°C to 175°C

Notes

- **RoHS Compliance**

The levels of RoHS restricted materials in this product are below the maximum concentration values (also referred to as the threshold limits) permitted for such substances, or are used in an exempted application, in accordance with EU Directive 2011/65/EC (RoHS2), as implemented January 2, 2013. RoHS Declarations for this product can be obtained from your Wolfspeed representative or from the Product Ecology section of our website at <http://www.wolfspeed.com/power/tools-and-support/product-ecology>.

- **REACH Compliance**

REACH substances of high concern (SVHCs) information is available for this product. Since the European Chemical Agency (ECHA) has published notice of their intent to frequently revise the SVHC listing for the foreseeable future, please contact a Cree representative to insure you get the most up-to-date REACH SVHC Declaration. REACH banned substance information (REACH Article 67) is also available upon request.

- This product has not been designed or tested for use in, and is not intended for use in, applications implanted into the human body nor in applications in which failure of the product could lead to death, personal injury or property damage, including but not limited to equipment used in the operation of nuclear facilities, life-support machines, cardiac defibrillators or similar emergency medical equipment, aircraft navigation or communication or control systems, or air traffic control systems.

Related Links

- Cree SiC Schottky diode portfolio: <http://www.wolfspeed.com/Power/Products#SiCSchottkyDiodes>
- Schottky diode Spice models: <http://www.wolfspeed.com/power/tools-and-support/DIODE-model-request2>
- SiC MOSFET and diode reference designs: <http://go.pardot.com/l/101562/2015-07-31/349i>