

2SC4152

Silicon NPN triple diffusion planar type

For high breakdown voltage high-speed switching

Features

- High-speed switching
- High collector to base voltage V_{CB0}
- Wide area of safe operation (ASO)
- Satisfactory linearity of forward current transfer ratio h_{FE}
- Full-pack package which can be installed to the heat sink with one screw

Absolute Maximum Ratings ($T_C=25^\circ\text{C}$)

Parameter	Symbol	Ratings	Unit	
Collector to base voltage	V_{CB0}	1400	V	
Collector to emitter voltage	V_{CER}	1400	V	
	V_{CEO}	700	V	
Emitter to base voltage	V_{EBO}	5	V	
Peak collector current	I_{CP}	1.0	A	
Collector current	I_C	0.3	A	
Collector power dissipation	P_C	$T_C=25^\circ\text{C}$	20	W
		$T_a=25^\circ\text{C}$	2	
Junction temperature	T_j	150	$^\circ\text{C}$	
Storage temperature	T_{stg}	-55 to +150	$^\circ\text{C}$	

Electrical Characteristics ($T_C=25^\circ\text{C}$)

Parameter	Symbol	Conditions	min	typ	max	Unit
Collector cutoff current	I_{CBO}	$V_{CB} = 1100\text{V}, I_E = 0$			10	μA
Emitter cutoff current	I_{EBO}	$V_{EB} = 4\text{V}, I_C = 0$			10	μA
Collector to emitter voltage	V_{CER}	$I_C = 1\text{mA}, R_{BE} = 100\Omega$	1400			V
	V_{CEO}	$I_C = 1\text{mA}, I_B = 0$	700			V
Emitter to base voltage	V_{EBO}	$I_E = 1\text{mA}, I_C = 0$	5			V
Forward current transfer ratio	h_{FE}	$V_{CE} = 5\text{V}, I_C = 30\text{mA}$	10		40	
Collector to emitter saturation voltage	$V_{CE(sat)}$	$I_C = 60\text{mA}, I_B = 6\text{mA}$			2	V
Base to emitter saturation voltage	$V_{BE(sat)}$	$I_C = 60\text{mA}, I_B = 6\text{mA}$			2	V
Transition frequency	f_T	$V_{CE} = 10\text{V}, I_C = 30\text{mA}, f = 1\text{MHz}$		12		MHz
Collector output capacitance	C_{ob}	$V_{CB} = 100\text{V}, I_E = 0, f = 1\text{MHz}$		6		pF
Turn-on time	t_{on}	$I_C = 0.15\text{A}, I_{B1} = 15\text{mA}, I_{B2} = -30\text{mA}, V_{CC} = 250\text{V}$			2	μs
Storage time	t_{stg}				3	μs
Fall time	t_f				1	μs

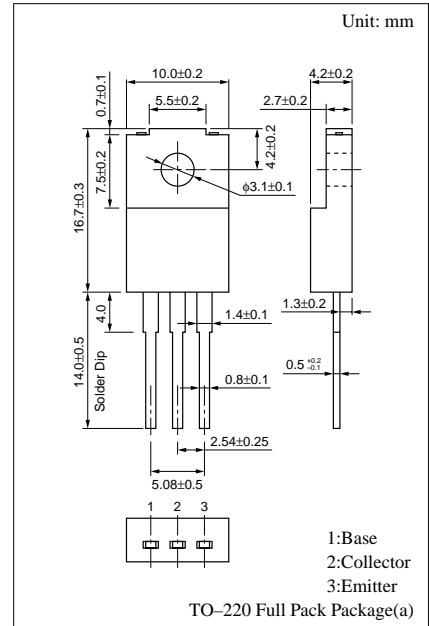

$P_C - T_a$

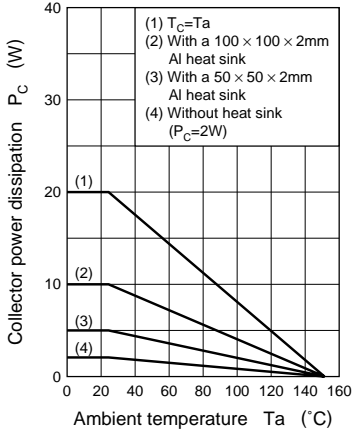

$I_C - V_{CE}$

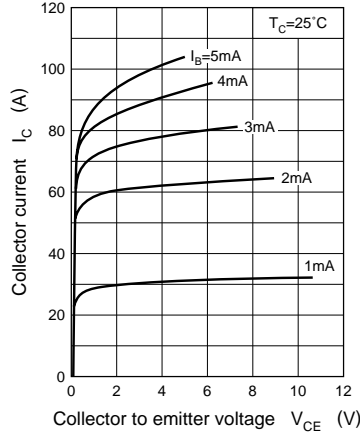

$V_{CE(sat)} - I_C$

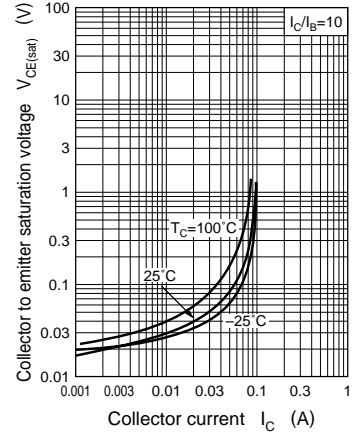

$V_{BE(sat)} - I_C$

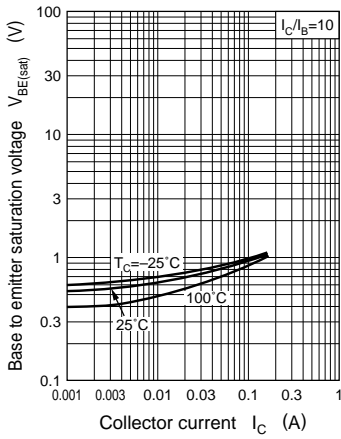

$h_{FE} - I_C$

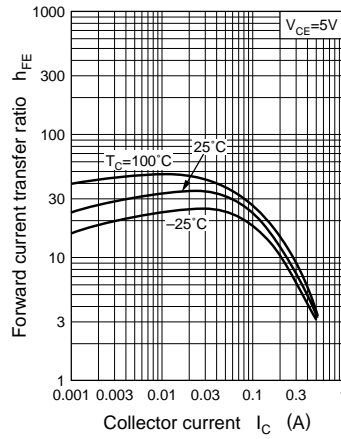

$f_T - I_C$

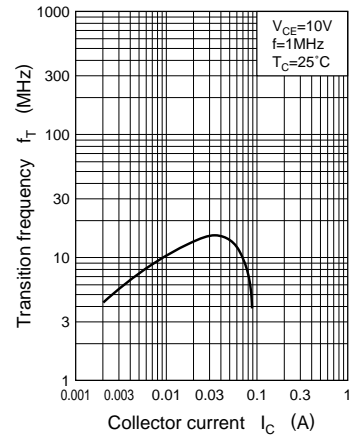

$C_{ob} - V_{CB}$

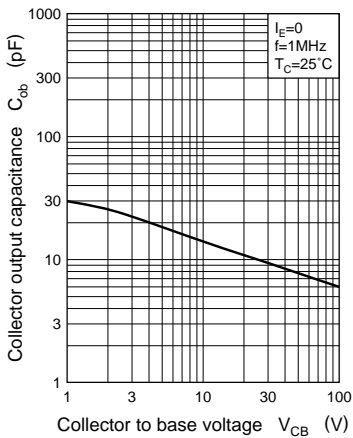

$t_{on}, t_{stg}, t_f - I_C$

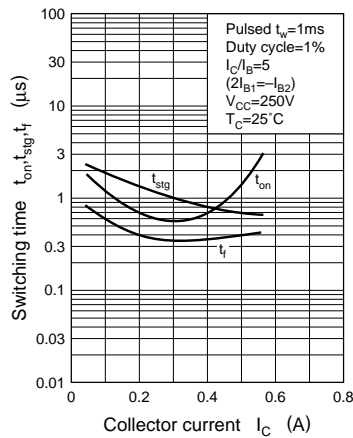

Area of safe operation (ASO)

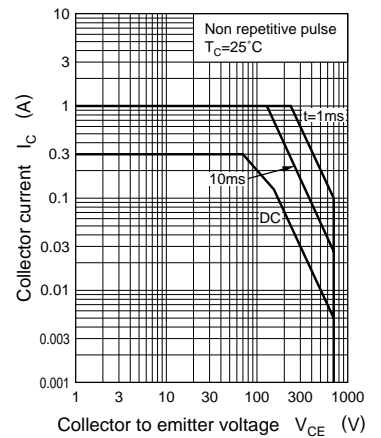

Area of safe operation, reverse bias ASO

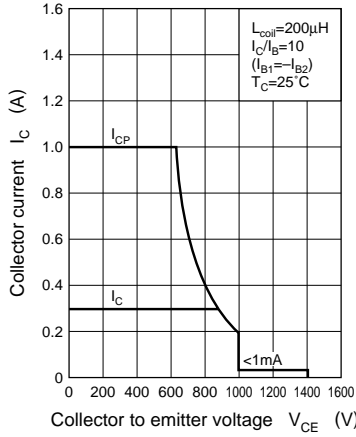

Reverse bias ASO measuring circuit

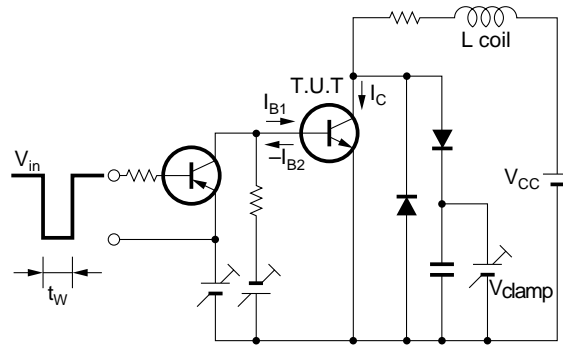

$R_{th(t)} - t$

