

TOSHIBA Transistor Silicon NPN Epitaxial Planar Type

2SC4317

VHF~UHF Band Low Noise Amplifier Applications

Unit: mm

- Low noise figure, high gain.
- $NF = 1.1\text{dB}$, $|S_{21e}|^2 = 13\text{dB}$ ($f = 1\text{GHz}$)

Maximum Ratings ($T_a = 25^\circ\text{C}$)

Characteristics	Symbol	Rating	Unit
Collector-base voltage	V_{CBO}	20	V
Collector-emitter voltage	V_{CEO}	10	V
Emitter-base voltage	V_{EBO}	1.5	V
Base current	I_B	20	mA
Collector current	I_C	40	mA
Collector power dissipation	P_C	150	mW
Junction temperature	T_j	125	$^\circ\text{C}$
Storage temperature range	T_{stg}	-55~125	$^\circ\text{C}$

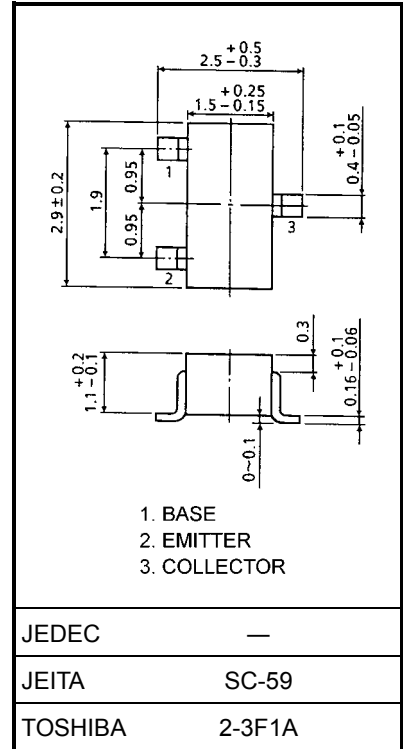

Microwave Characteristics ($T_a = 25^\circ\text{C}$)

Weight: 0.012 g (typ.)

Characteristics	Symbol	Test Condition	Min	Typ.	Max	Unit
Transition frequency	f_T	$V_{CE} = 8\text{V}$, $I_C = 20\text{mA}$	7	10	—	GHz
Insertion gain	$ S_{21e} ^2 (1)$	$V_{CE} = 8\text{V}$, $I_C = 20\text{mA}$, $f = 1\text{GHz}$	10	13	—	dB
	$ S_{21e} ^2 (2)$	$V_{CE} = 8\text{V}$, $I_C = 20\text{mA}$, $f = 2\text{GHz}$	—	7	—	
Noise figure	NF (1)	$V_{CE} = 8\text{V}$, $I_C = 5\text{mA}$, $f = 1\text{GHz}$	—	1.1	2.5	dB
	NF (2)	$V_{CE} = 8\text{V}$, $I_C = 5\text{mA}$, $f = 2\text{GHz}$	—	1.7	—	

Electrical Characteristics ($T_a = 25^\circ\text{C}$)

Characteristics	Symbol	Test Condition	Min	Typ.	Max	Unit
Collector cut-off current	I_{CBO}	$V_{CB} = 10\text{V}$, $I_E = 0$	—	—	1	μA
Emitter cut-off current	I_{EBO}	$V_{EB} = 1\text{V}$, $I_C = 0$	—	—	1	μA
DC current gain	h_{FE}	$V_{CE} = 8\text{V}$, $I_C = 20\text{mA}$	50	—	250	
Output capacitance	C_{ob}	$V_{CB} = 10\text{V}$, $I_E = 0$, $f = 1\text{MHz}$ (Note)	—	0.65	—	pF
Reverse transfer capacitance	C_{re}		—	0.45	0.9	pF

Note: C_{re} is measured by 3 terminal method with capacitance bridge.

Marking

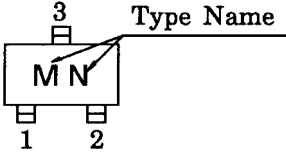

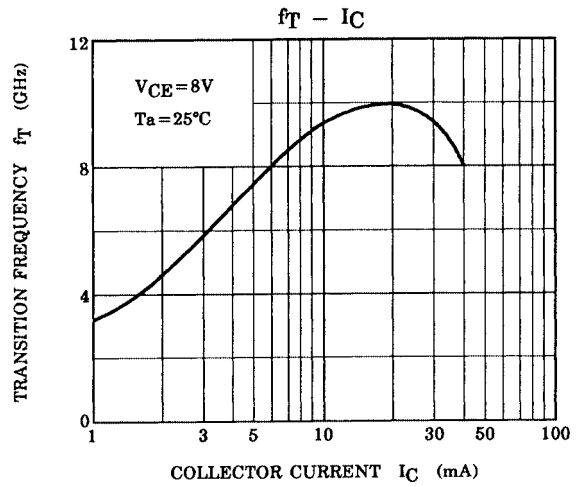
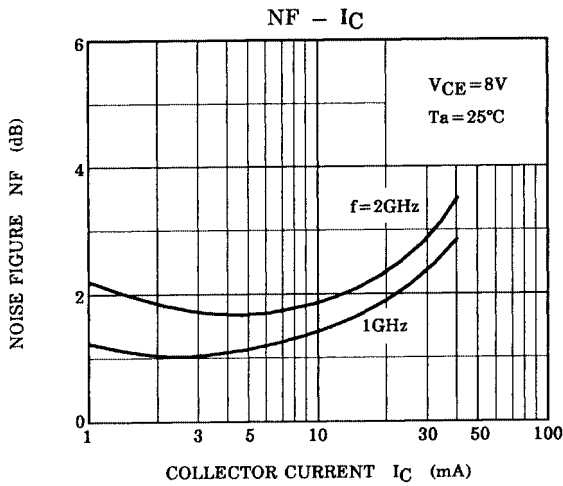
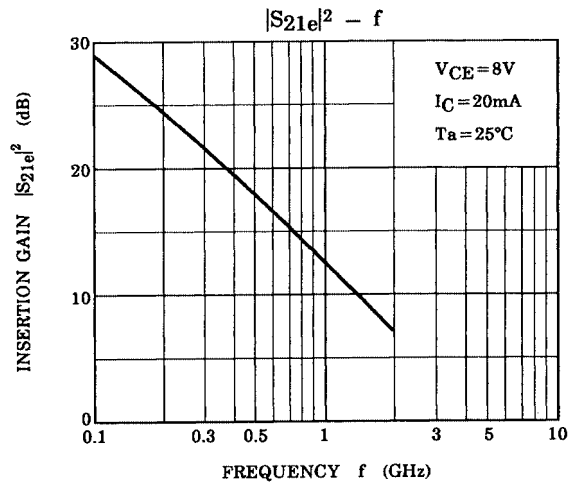
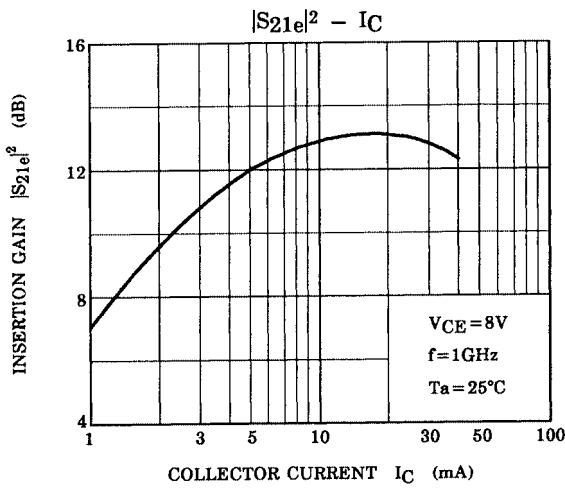
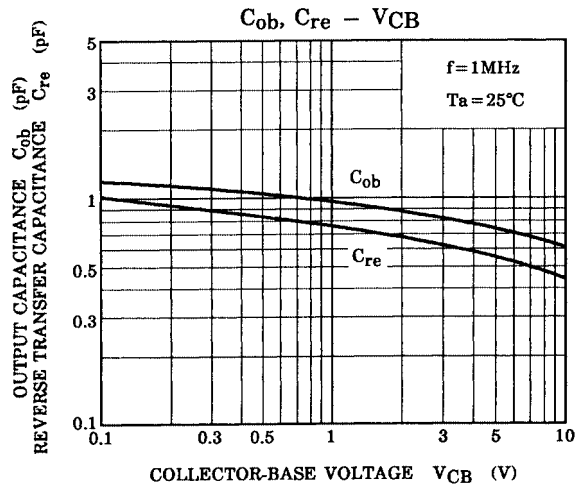
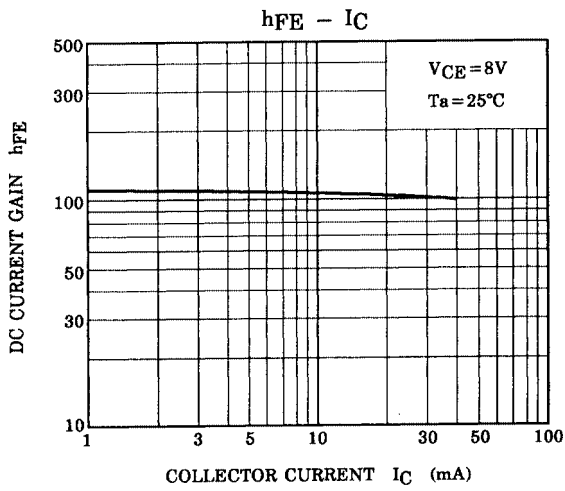

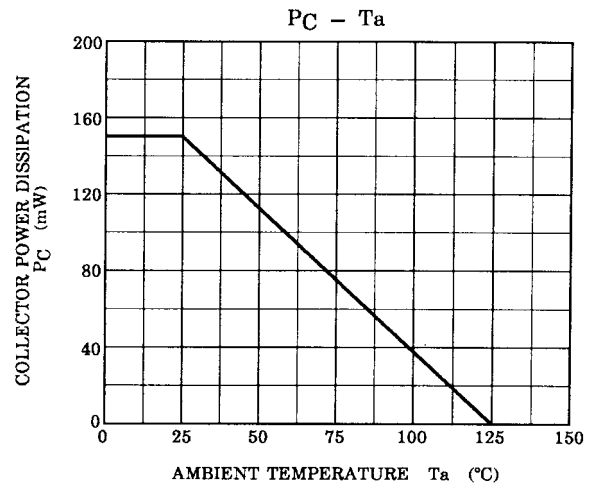
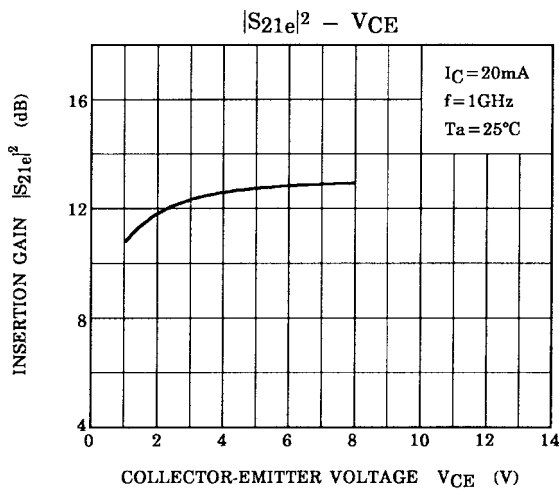

S-Parameter $Z_O = 50 \Omega, T_a = 25^\circ C$

$V_{CE} = 8 V, I_C = 5 mA$

Frequency MHz	S11		S21		S12		S22	
	MAG	ANG	MAG	ANG	MAG	ANG	MAG	ANG
200	0.649	-46.9	11.454	139.7	0.044	67.8	0.823	-26.1
400	0.426	-78.5	8.028	116.2	0.068	61.0	0.623	-36.4
600	0.282	-100.9	5.965	102.6	0.085	60.4	0.513	-39.5
800	0.192	-122.5	4.688	92.7	0.103	61.5	0.452	-40.3
1000	0.131	-147.7	3.856	85.4	0.121	62.6	0.422	-41.1
1200	0.099	-175.5	3.308	78.9	0.140	63.2	0.406	-42.0
1400	0.096	145.6	2.871	72.7	0.159	63.2	0.404	-43.5
1600	0.091	116.0	2.562	68.0	0.179	63.0	0.402	-45.9
1800	0.111	93.4	2.341	62.9	0.199	62.5	0.406	-49.1
2000	0.115	78.3	2.106	59.5	0.218	62.0	0.409	-53.1

$V_{CE} = 8 V, I_C = 20 mA$

Frequency MHz	S11		S21		S12		S22	
	MAG	ANG	MAG	ANG	MAG	ANG	MAG	ANG
200	0.278	-78.9	18.400	118.0	0.031	71.1	0.586	-33.3
400	0.138	-120.1	10.350	99.6	0.053	73.5	0.426	-32.4
600	0.088	-159.6	7.137	90.4	0.076	74.1	0.379	-30.1
800	0.084	157.2	5.433	83.4	0.100	73.9	0.361	-29.1
1000	0.096	122.5	4.401	78.0	0.123	73.1	0.356	-29.7
1200	0.117	99.7	3.719	73.0	0.147	71.5	0.357	-31.3
1400	0.141	84.9	3.216	67.9	0.170	69.9	0.364	-33.6
1600	0.152	69.0	2.849	63.9	0.192	68.3	0.372	-37.0
1800	0.167	59.2	2.577	59.6	0.215	66.3	0.381	-41.3
2000	0.169	49.4	2.304	56.3	0.235	64.7	0.386	-46.3

S11e
 VCE=8V
 IC=5mA
 Ta=25°C
 (UNIT : Ω)

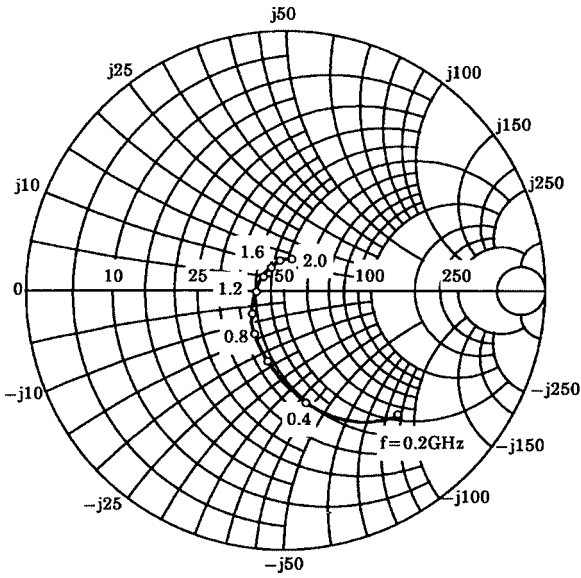

S21e
 VCE=8V
 IC=5mA
 Ta=25°C

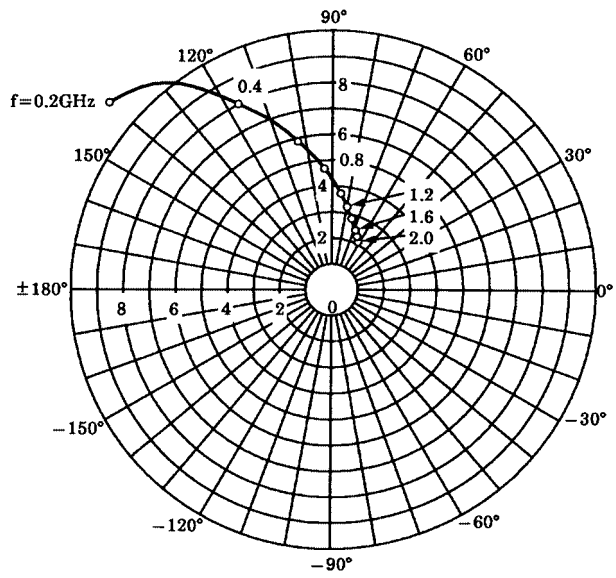

S12e
 VCE=8V
 IC=5mA
 Ta=25°C

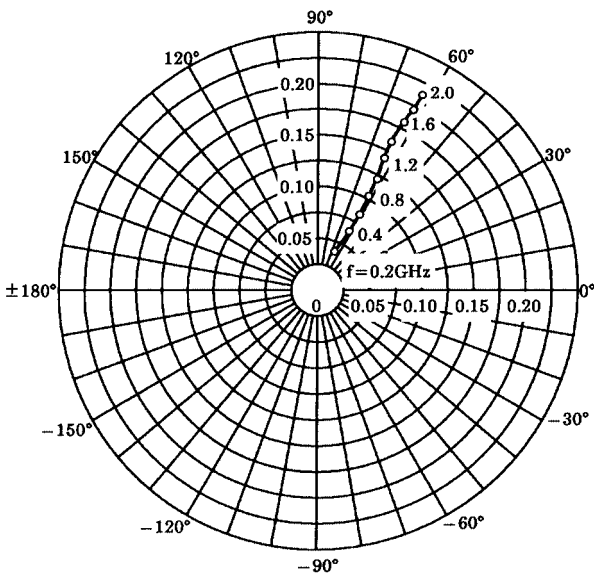

S22e
 VCE=8V
 IC=5mA
 Ta=25°C
 (UNIT : Ω)

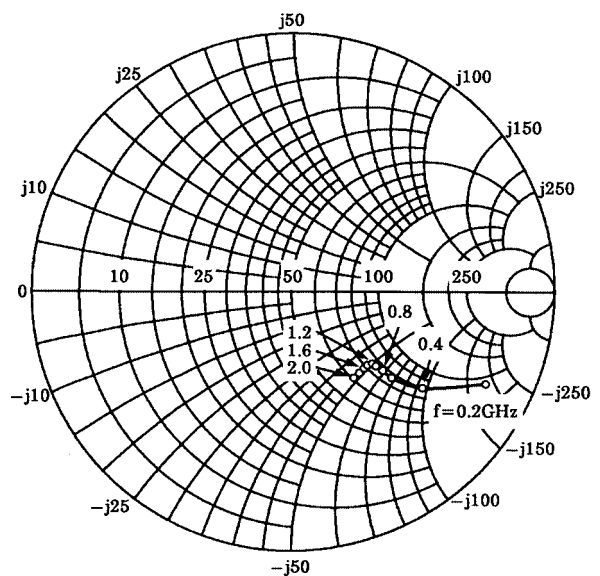

S11e
 VCE=8V
 IC=20mA
 Ta=25°C
 (UNIT : Ω)

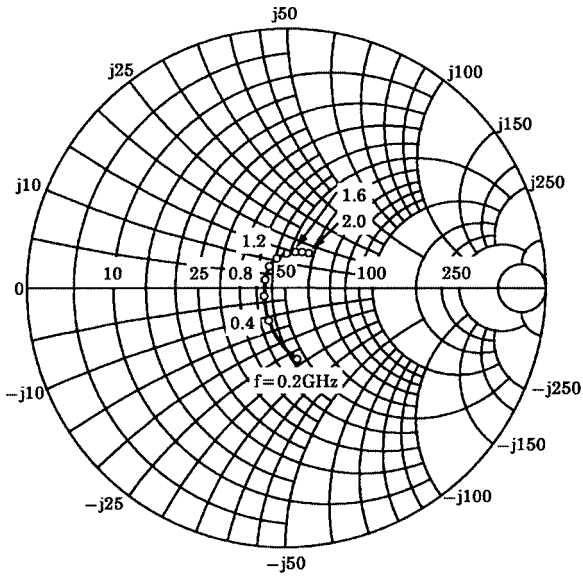

S21e
 VCE=8V
 IC=20mA
 Ta=25°C

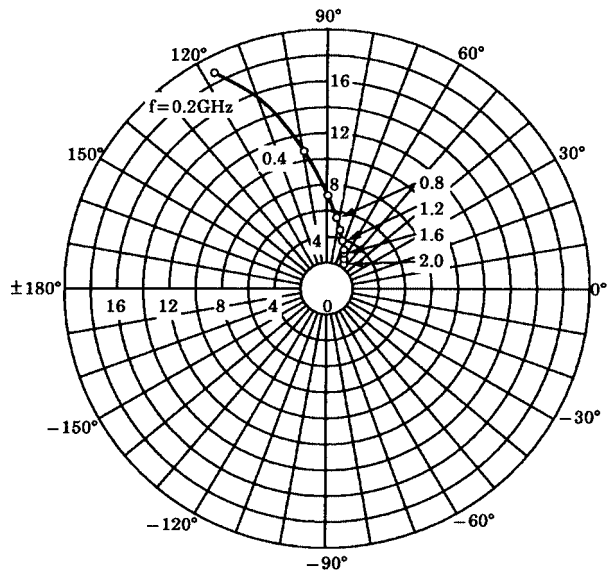

S12e
 VCE=8V
 IC=20mA
 Ta=25°C

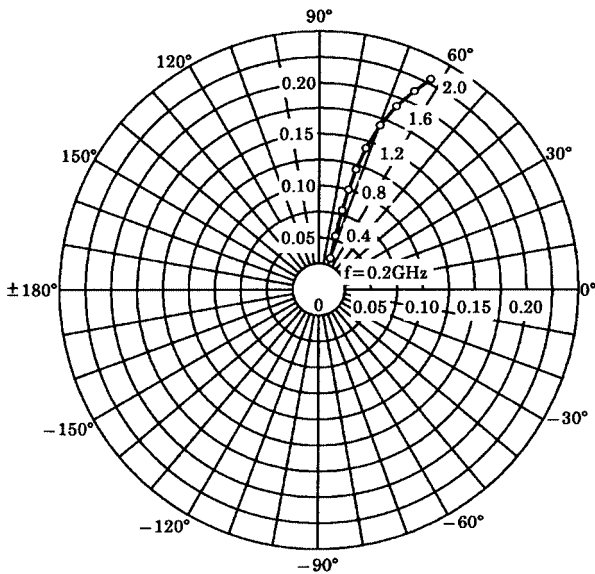

S22e
 VCE=8V
 IC=20mA
 Ta=25°C
 (UNIT : Ω)

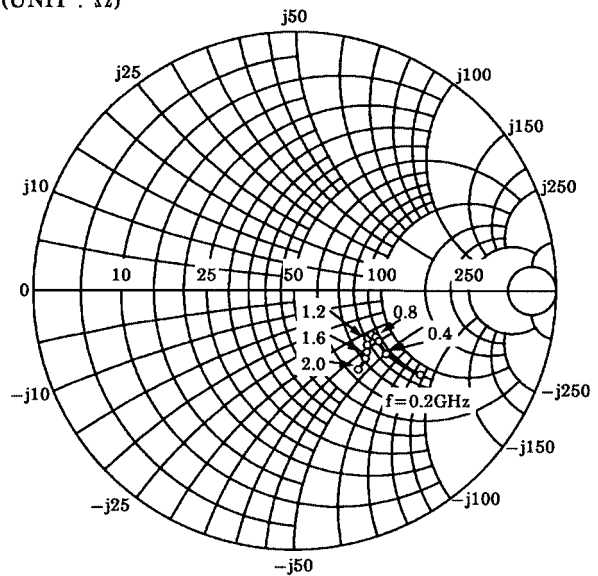

RESTRICTIONS ON PRODUCT USE

000707EAA

- TOSHIBA is continually working to improve the quality and reliability of its products. Nevertheless, semiconductor devices in general can malfunction or fail due to their inherent electrical sensitivity and vulnerability to physical stress. It is the responsibility of the buyer, when utilizing TOSHIBA products, to comply with the standards of safety in making a safe design for the entire system, and to avoid situations in which a malfunction or failure of such TOSHIBA products could cause loss of human life, bodily injury or damage to property.
In developing your designs, please ensure that TOSHIBA products are used within specified operating ranges as set forth in the most recent TOSHIBA products specifications. Also, please keep in mind the precautions and conditions set forth in the "Handling Guide for Semiconductor Devices," or "TOSHIBA Semiconductor Reliability Handbook" etc..
- The TOSHIBA products listed in this document are intended for usage in general electronics applications (computer, personal equipment, office equipment, measuring equipment, industrial robotics, domestic appliances, etc.). These TOSHIBA products are neither intended nor warranted for usage in equipment that requires extraordinarily high quality and/or reliability or a malfunction or failure of which may cause loss of human life or bodily injury ("Unintended Usage"). Unintended Usage include atomic energy control instruments, airplane or spaceship instruments, transportation instruments, traffic signal instruments, combustion control instruments, medical instruments, all types of safety devices, etc.. Unintended Usage of TOSHIBA products listed in this document shall be made at the customer's own risk.
- The information contained herein is presented only as a guide for the applications of our products. No responsibility is assumed by TOSHIBA CORPORATION for any infringements of intellectual property or other rights of the third parties which may result from its use. No license is granted by implication or otherwise under any intellectual property or other rights of TOSHIBA CORPORATION or others.
- The information contained herein is subject to change without notice.