

Silicon NPN Power Transistors

2SC4385

DESCRIPTION

- With TO-3PML package
- Complement to type 2SA1670

APPLICATIONS

- Audio and general purpose

PINNING

PIN	DESCRIPTION
1	Base
2	Collector
3	Emitter

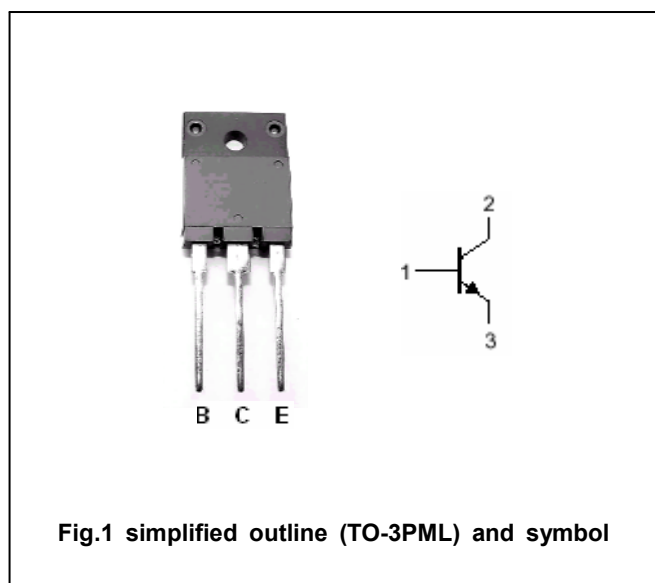

Fig.1 simplified outline (TO-3PML) and symbol

Absolute maximum ratings($T_a=25^\circ\text{C}$)

SYMBOL	PARAMETER	CONDITIONS	VALUE	UNIT
V_{CBO}	Collector-base voltage	Open emitter	120	V
V_{CEO}	Collector-emitter voltage	Open base	80	V
V_{EBO}	Emitter-base voltage	Open collector	6	V
I_C	Collector current		6	A
I_B	Base current		3	A
P_C	Collector power dissipation	$T_C=25^\circ\text{C}$	60	W
T_j	Junction temperature		150	$^\circ\text{C}$
T_{stg}	Storage temperature		-55~150	$^\circ\text{C}$

Silicon NPN Power Transistors

2SC4385

CHARACTERISTICS

Tj=25°C unless otherwise specified

SYMBOL	PARAMETER	CONDITIONS	MIN	TYP.	MAX	UNIT
$V_{(BR)CEO}$	Collector-emitter breakdown voltage	$I_C=50mA; I_B=0$	80			V
$V_{(BR)EBO}$	Emitter-base breakdown voltage	$I_E=1mA; I_C=0$	6			V
V_{CEsat}	Collector-emitter saturation voltage	$I_C=2A; I_B=0.2A$			1.5	V
I_{CBO}	Collector cut-off current	$V_{CB}=120V; I_E=0$			10	μA
I_{EBO}	Emitter cut-off current	$V_{EB}=6V; I_C=0$			10	μA
h_{FE}	DC current gain	$I_C=2A; V_{CE}=4V$	50		180	
f_T	Transition frequency	$I_E=-0.5A; V_{CE}=12V$		20		MHz

◆ h_{FE} classifications

O	P	Y
50-100	70-140	90-180

Silicon NPN Power Transistors

2SC4385

PACKAGE OUTLINE

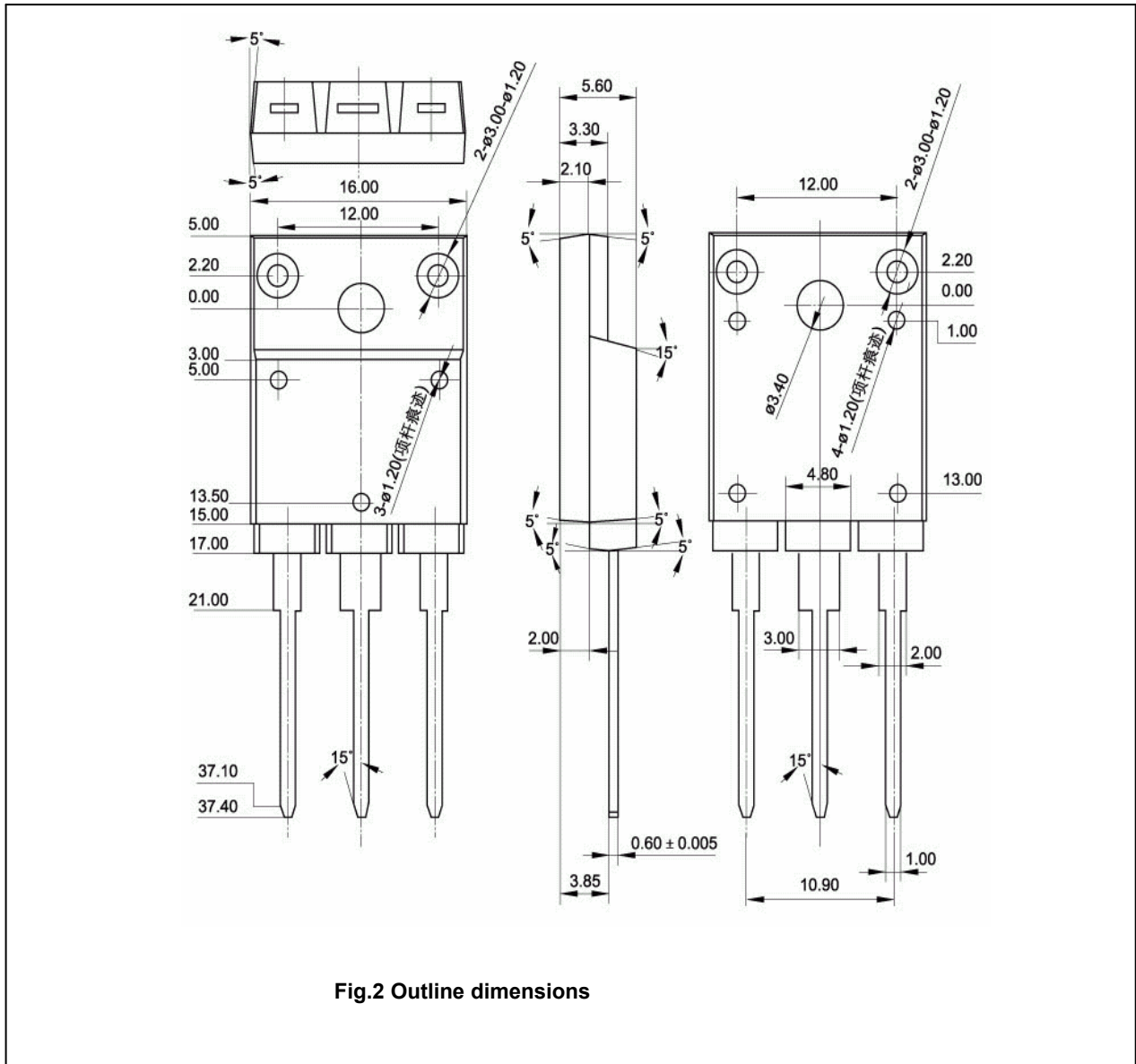

Fig.2 Outline dimensions