

**2SC4664**  
**(TP8V20FS)**

**8A NPN**

### OUTLINE DIMENSIONS

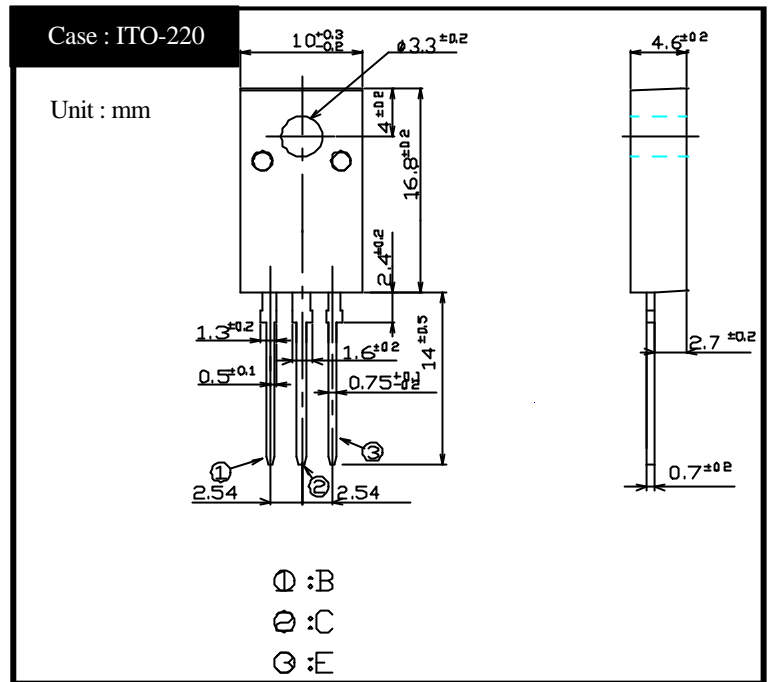

### RATINGS

#### Absolute Maximum Ratings

| Item                         | Symbol           | Conditions                     | Ratings   | Unit |
|------------------------------|------------------|--------------------------------|-----------|------|
| Storage Temperature          | T <sub>stg</sub> |                                | -55 ~ 150 |      |
| Junction Temperature         | T <sub>j</sub>   |                                | 150       |      |
| Collector to Base Voltage    | V <sub>CB0</sub> |                                | 250       | V    |
| Collector to Emitter Voltage | V <sub>CE0</sub> |                                | 200       | V    |
| Emitter to Base Voltage      | V <sub>EBO</sub> |                                | 7         | V    |
| Collector Current DC         | I <sub>C</sub>   |                                | 8         | A    |
| Collector Current Peak       | I <sub>CP</sub>  |                                | 16        |      |
| Base Current DC              | I <sub>B</sub>   |                                | 3         | A    |
| Base Current Peak            | I <sub>BP</sub>  |                                | 6         |      |
| Total Transistor Dissipation | P <sub>T</sub>   | T <sub>C</sub> = 25            | 30        | W    |
| Dielectric Strength          | V <sub>dis</sub> | Terminals to case, AC 1 minute | 2         | kV   |
| Mounting Torque              | TOR              | (Recommended torque : 0.3N·m)  | 0.5       | N·m  |

#### Electrical Characteristics (T<sub>C</sub>=25 )

| Item                                    | Symbol                | Conditions                                     | Ratings               | Unit |
|---|-----------------------|--|-----------------------|------|
| Collector to Emitter Sustaining Voltage | V <sub>CE0(sus)</sub> | I <sub>C</sub> = 0.1A                          | Min 200               | V    |
| Collector Cutoff Current                | I <sub>CB0</sub>      | At rated Voltage                               | Max 0.1               | mA   |
|   |                       |  | Max 0.1               |      |
| Emitter Cutoff Current                  | I <sub>EBO</sub>      | At rated Voltage                               | Max 0.1               | mA   |
| DC Current Gain                         | h <sub>FE</sub>       | V <sub>CE</sub> = 2V, I <sub>C</sub> = 4A      | 10 ~ 25 <sup>*1</sup> |      |
|   |                       |  | h <sub>FEL</sub>      |      |
| Collector to Emitter Saturation Voltage | V <sub>CE(sat)</sub>  | I <sub>C</sub> = 4A                            | Max 1.0               | V    |
| Base to Emitter Saturation Voltage      | V <sub>BE(sat)</sub>  | I <sub>B</sub> = 0.8A                          | Max 1.5               | V    |
| Thermal Resistance                      | j <sub>C</sub>        | Junction to case                               | Max 4.17              | /W   |
| Transition Frequency                    | f <sub>T</sub>        | V <sub>CE</sub> = 10V, I <sub>C</sub> = 0.8A   | TYP 13                | MHz  |
| Turn on Time                            | ton                   | I <sub>C</sub> = 4A                            | Max 0.3               | μs   |
| Storage Time                            | ts                    | I <sub>B1</sub> = 0.8A, I <sub>B2</sub> = 1.6A | Max 1.0               |      |
| Fall Time                               | tf                    | R <sub>L</sub> = 37.5 , V <sub>BB2</sub> = 4V  | Max 0.1               |      |

# 2SC4664 $h_{FE} - I_C$

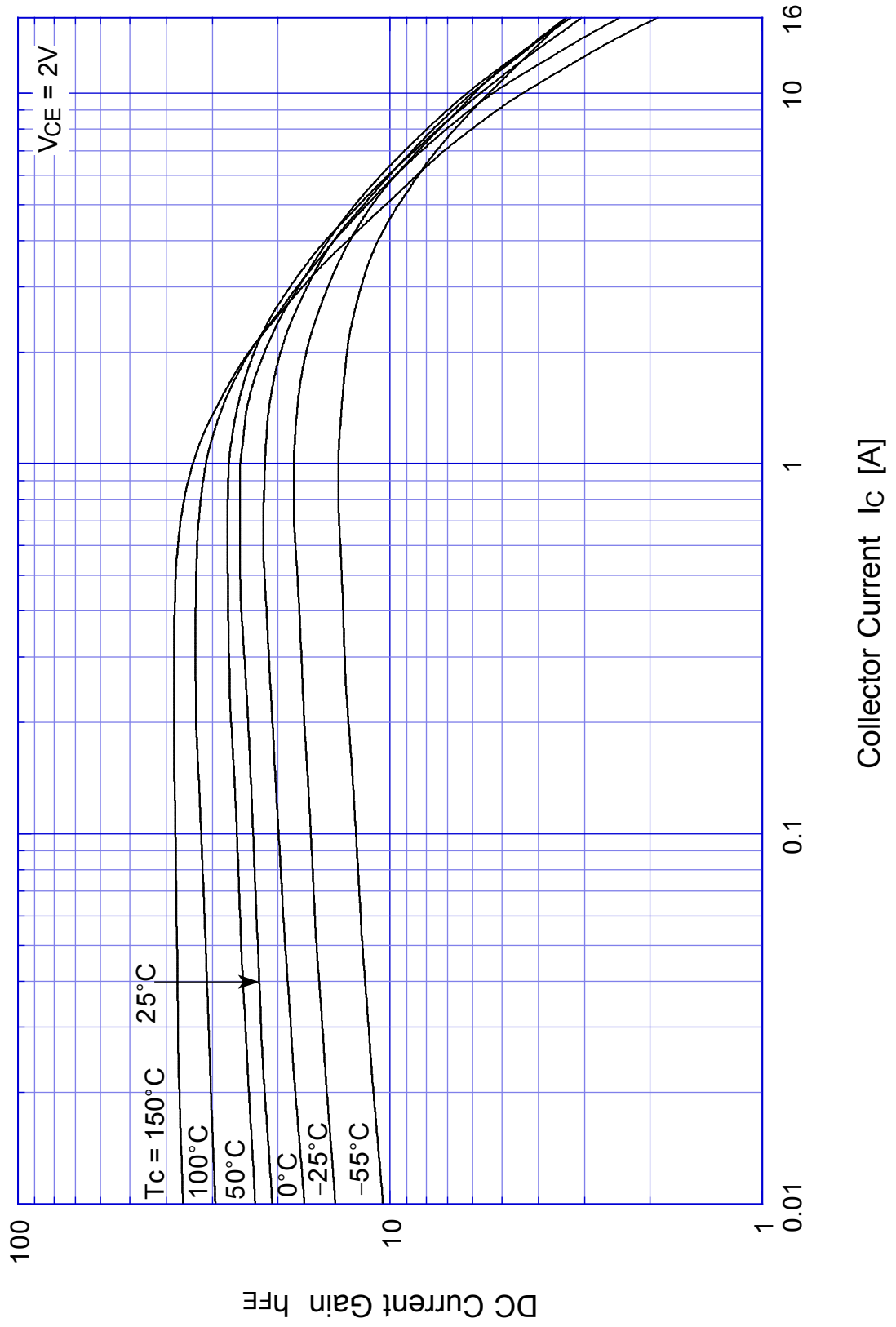

# 2SC4664 Saturation Voltage

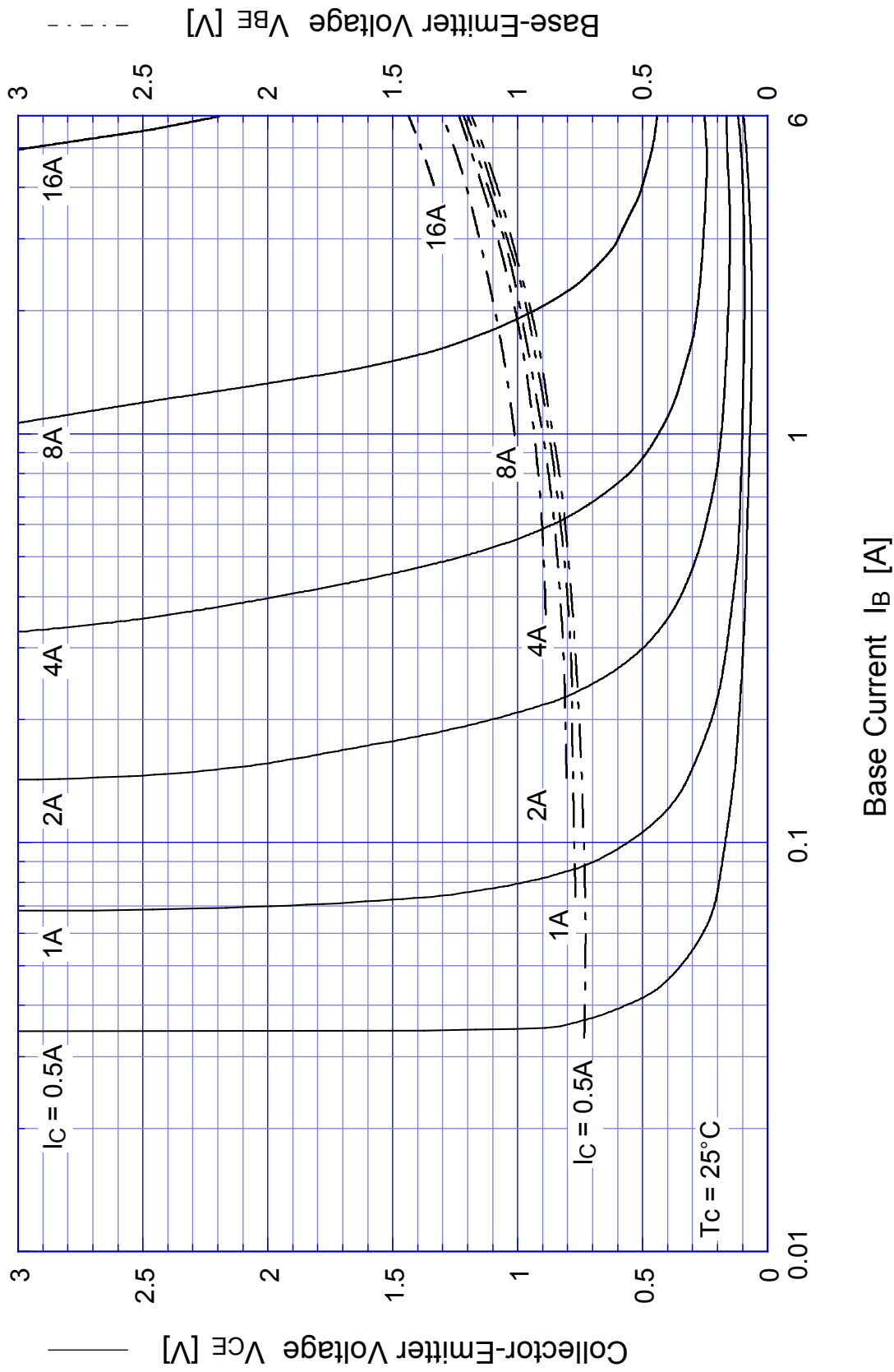

# 2SC4664

## Switching Time - $I_C$

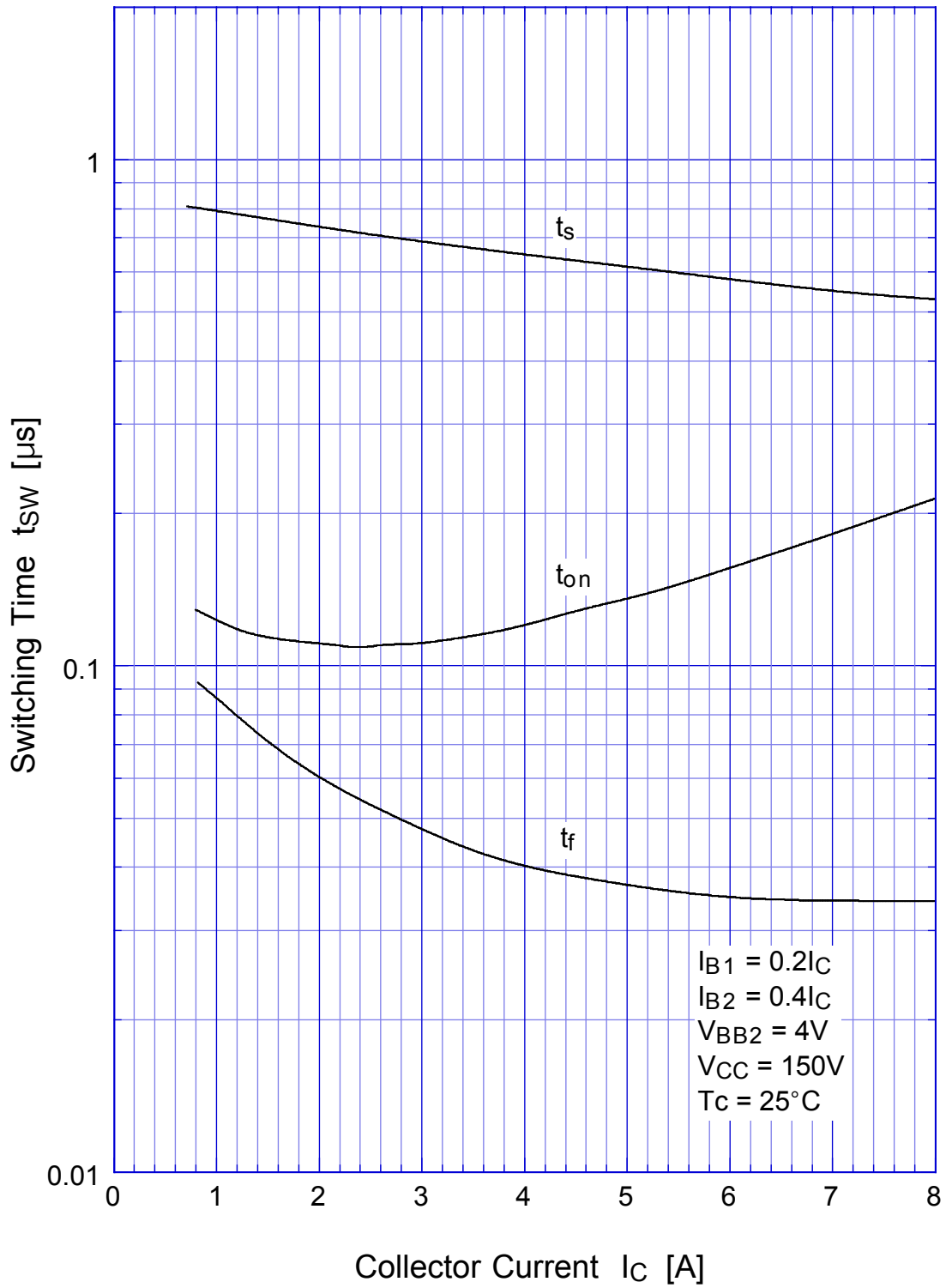

# 2SC4664

## Switching Time - Tc

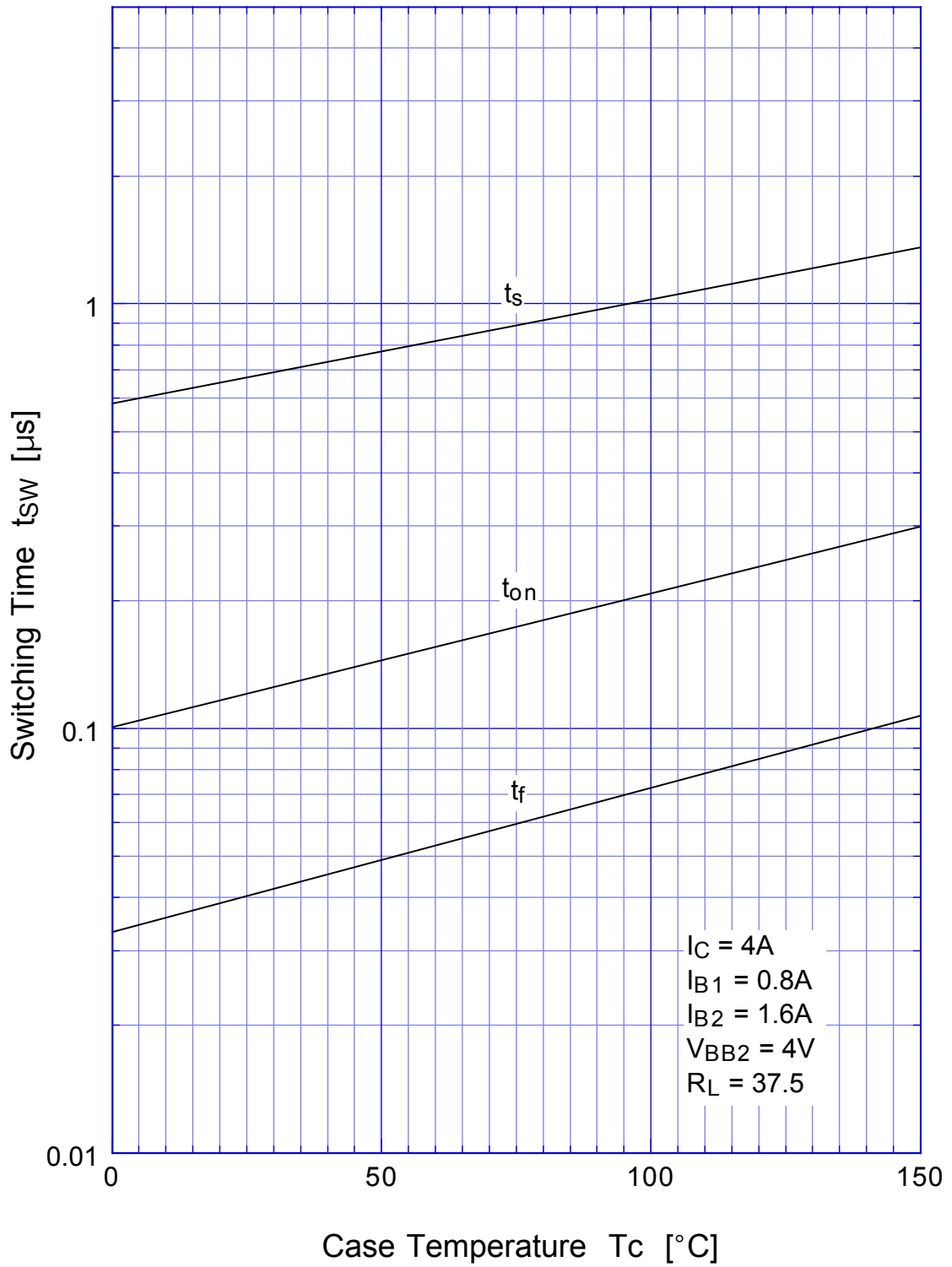

# 2SC4664

## Forward Bias SOA

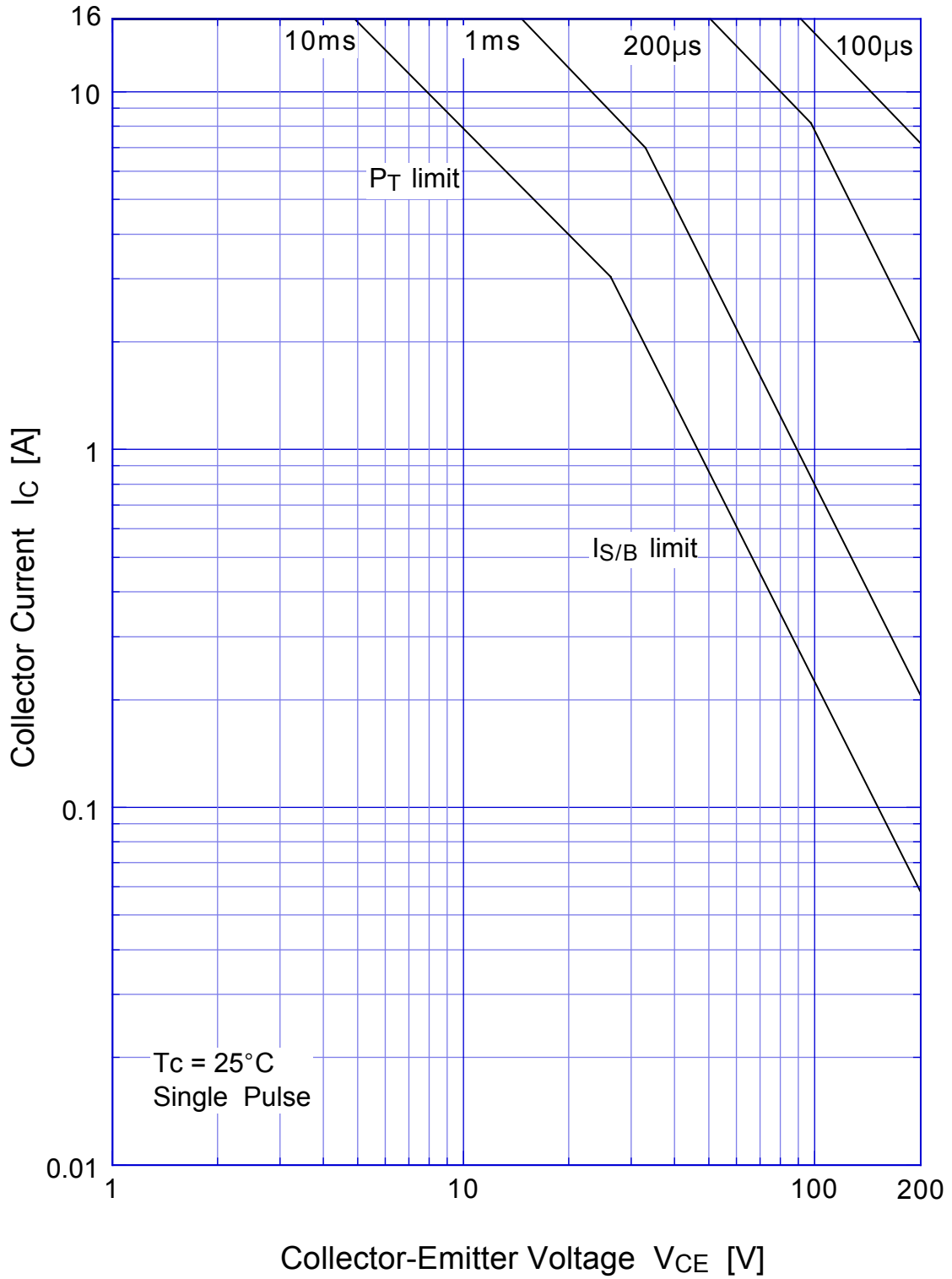

## 2SC4664 Collector Current Derating

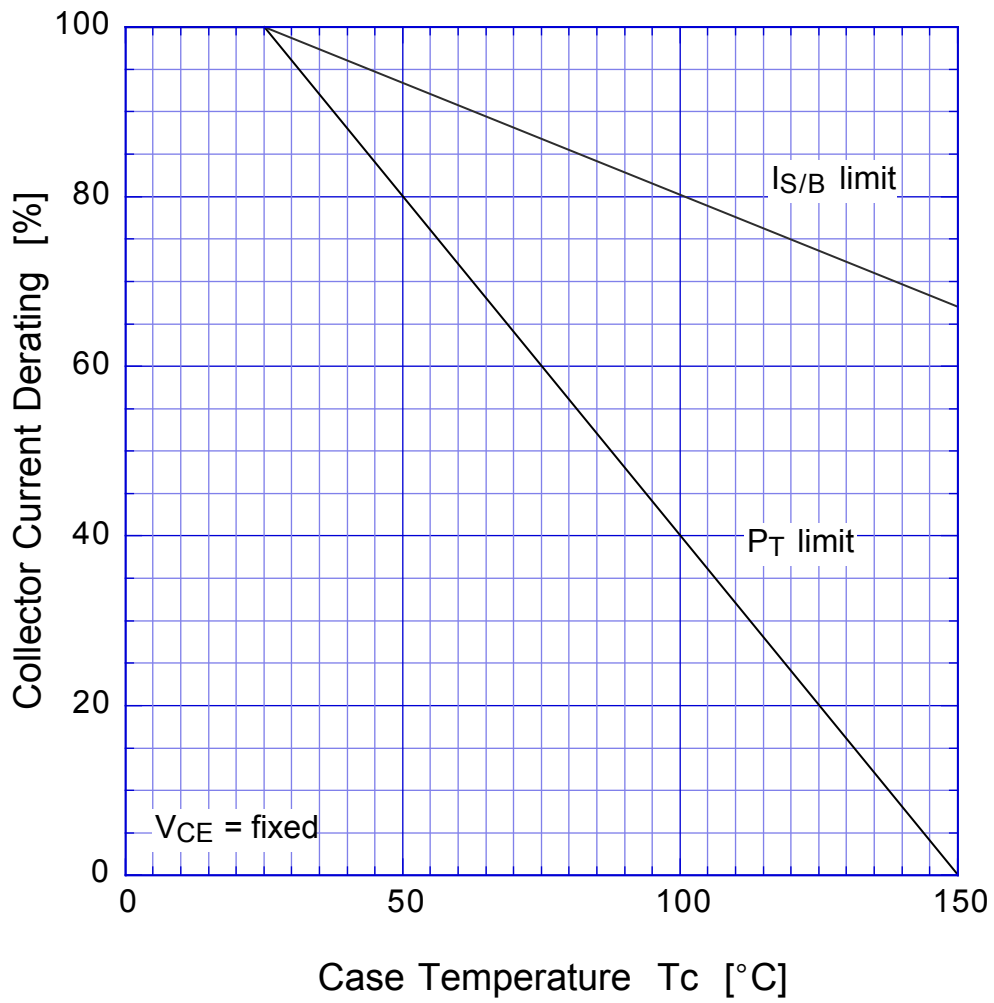

# 2SC4664

## Reverse Bias SOA

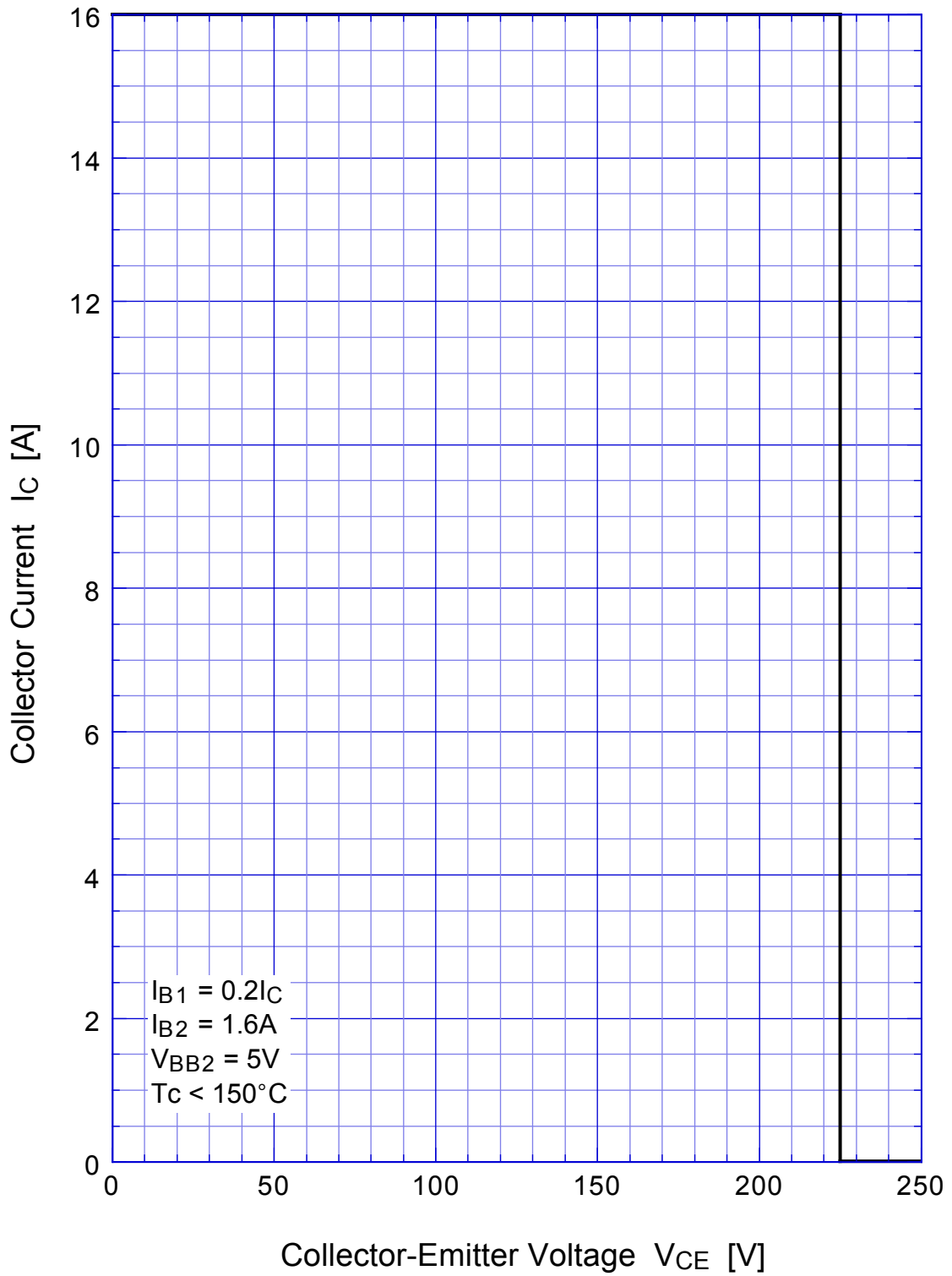



### 2SC4664 Transient Thermal Impedance

