

Cree® UltraThin® Gen 3 LEDs

Data Sheet

CxxxUT170-Sxxxx-31

Cree's UltraThin® LEDs combine highly efficient InGaN materials with Cree's proprietary G•SiC® substrate to deliver superior price/performance for blue LEDs. These vertically structured LED chips are small in size and require a low forward voltage. Cree's UT™ series chips are tested for conformity to optical and electrical specifications, as well as the ability to withstand 2000 V ESD. Applications include consumer products, mobile devices and automotive applications where a small, thin form factor is required.

FEATURES

- Small Chip – 170 x 170 x 50 μm
- Single Wire Bond Structure
- UT LED Performance
 - 450 nm – 12+ mW
 - 460 nm – 10+ mW
 - 470 nm – 10+ mW
 - 527 nm – 4+ mW
- Low Forward Voltage
 - 2.9 V Typical at 5 mA
- 2kV Class 2 ESD Rating

APPLICATIONS

- Indicator Applications
 - Consumer Products
 - Mobile Devices
 - Product Displays
 - White Goods
- Automotive Applications
 - Interior Indicators
 - Meter Cluster Lighting
 - Center Stack Displays

CxxxUT170-Sxxxx-31 Chip Diagram

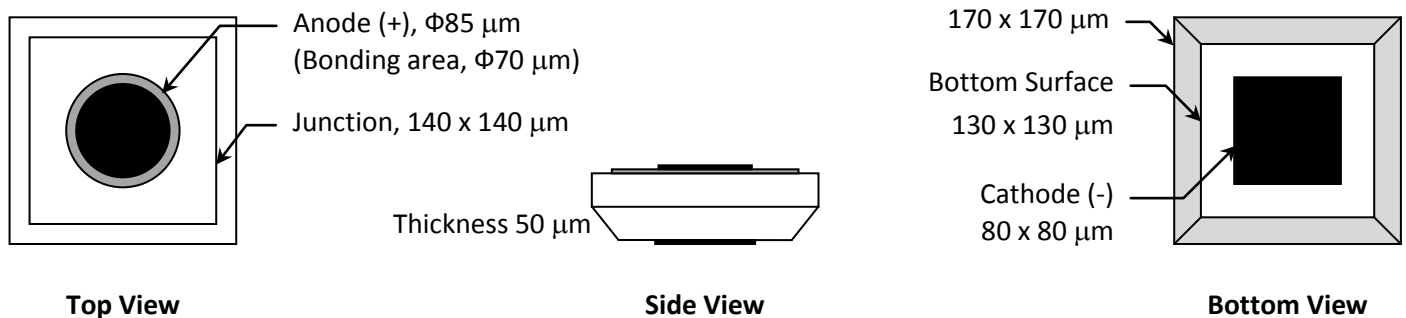

Data Sheet: CPR3GQ Rev. A

Maximum Ratings at $T_A = 25^\circ\text{C}$ <small>Notes 1&3</small>		CxxxUT170-Sxxxx-31
DC Forward Current		30 mA
Peak Forward Current (1/10 duty cycle @ 1 kHz)		70 mA
LED Junction Temperature		125°C
Reverse Voltage		5 V
Operating Temperature Range		-40°C to +100°C
LED Chip Storage Temperature Range (LED Chip only, not for Die Sheet Storage)		-40°C to +120°C
Recommended Die Sheet Storage Conditions		$\leq 30^\circ\text{C}$ / $\leq 85\%$ RH
Electrostatic Discharge Threshold (HBM) <small>Note 2</small>		2000 V
Electrostatic Discharge Classification (MIL-STD-883E) <small>Note 2</small>		Class 2

Typical Electrical/Optical Characteristics at $T_A = 25^\circ\text{C}$, $I_f = 5\text{ mA}$ <small>Note 3</small>					
Part Number	Forward Voltage (V_f , V)			Reverse Current [$I(V_r=5\text{ V})$, μA]	Full Width Half Max (λ_D , nm)
	Min.	Typ.	Max.	Max.	Typ.
C450UT170-Sxxxx-31	2.7	2.9	3.1	2	21
C460UT170-Sxxxx-31	2.7	2.9	3.1	2	21
C470UT170-Sxxxx-31	2.7	2.9	3.1	2	22
C527UT170-Sxxxx-31	2.7	3.0	3.2	2	35

Mechanical Specifications		CxxxUT170-Sxxxx-31	
Description	Dimension	Tolerance	
P-N Junction Area (μm)	140 x 140	± 25	
Chip Top Area (μm)	170 x 170	± 25	
Chip Thickness (μm)	50	± 10	
Chip Bottom Area (μm)	130 x 130	± 25	
Au Bond Pad Diameter (μm)	85	-5, +15	
Bonding Area Diameter (μm) <small>Note 5</small>	70	-5, +15	
Au Bond Pad Thickness (μm)	1.2	± 0.5	
Backside Contact Metal Area (μm)	80 x 80	± 25	

Notes:

- Maximum ratings are package dependent. The above ratings were determined using a thru-hole package (with Hysol® OS4000 encapsulant) for characterization. Ratings for other packages may differ. The forward currents (DC and Peak) are not limited by the die but by the effect of the LED junction temperature on the package. The junction temperature limit of 125°C is a limit of the thru-hole package; junction temperature should be characterized in a specific package to determine limitations. Assembly processing temperature must not exceed 325°C (< 5 seconds).
- Product resistance to electrostatic discharge (ESD) according to the HBM is measured by simulating ESD using a rapid avalanche energy test (RAET). The RAET procedures are designed to approximate the minimum ESD ratings shown. The ESD classification of Class 2 is based on sample testing according to MIL-STD-883E.
- All products conform to the listed minimum and maximum specifications for electrical and optical characteristics when assembled and operated at 5 mA within the maximum ratings shown above. Efficiency decreases at higher currents. Typical values given are within the range of average values expected by manufacturer in large quantities and are provided for information only. All measurements were made using lamps in thru-hole packages (with Hysol OS4000 encapsulant). Optical characteristics measured in an integrating sphere using Illuminance E.
- Caution: To obtain optimum output efficiency, the amount of epoxy used should be characterized based upon the specific application.
- Bonding Area is defined as the bond pad area exposed through the opening in the passivation layer. Care should be taken to prevent the wire bond from overlapping the passivation layer to maintain optimal bond performance and minimize the risk of mechanical damage.

Standard Bins for CxxxUT170-Sxxxx-31

LED chips are sorted to the **radiant flux** (RF) and **dominant wavelength** (DW) bins shown. Sorted die sheets contain die from only one bin. Sorted die kit (CxxxUT170-Sxxxx-31) orders may be filled with any or all bins (CxxxUT170-xxxx-31) contained in the kit. All RF values are measured at $I_f = 20$ mA and all DW values are measured at $I_f = 5$ mA.

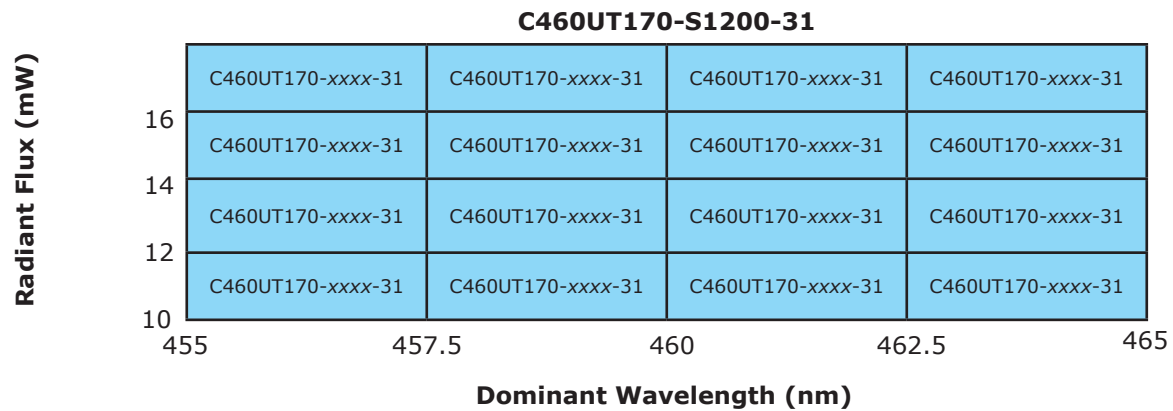
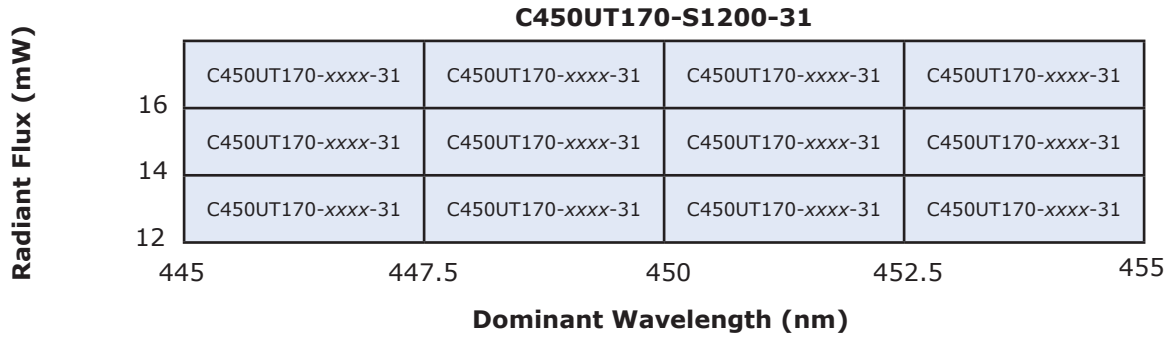

Standard Bins for CxxxUT170-Sxxxx-31 (continued)

LED chips are sorted to the **radiant flux** (RF) and **dominant wavelength** (DW) bins shown. Sorted die sheets contain die from only one bin. Sorted die kit (CxxxUT170-Sxxxx-31) orders may be filled with any or all bins (CxxxUT170-xxxx-31) contained in the kit. All RF values are measured at $I_f = 20$ mA and all DW values are measured at $I_f = 5$ mA.

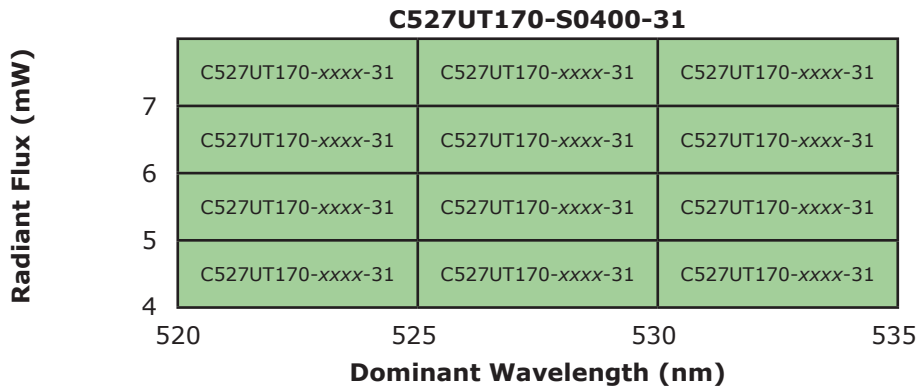
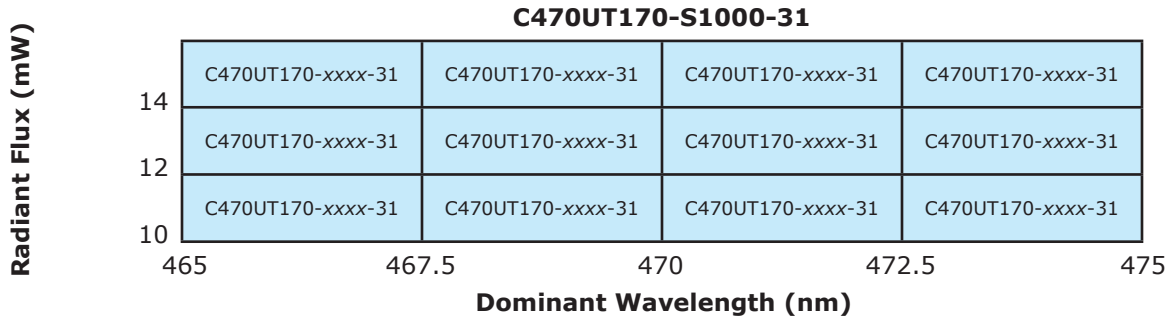

Standard Bins for CxxxUT170-Sxxxx-31

These are representative measurements for the UT product. Actual curves will vary slightly for the various radiant flux and dominant wavelength bins.

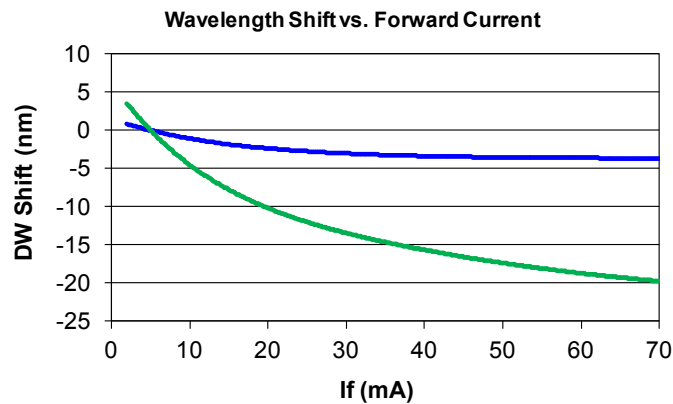
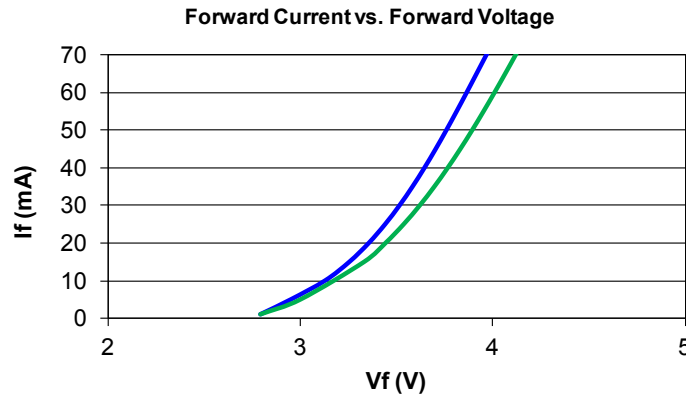
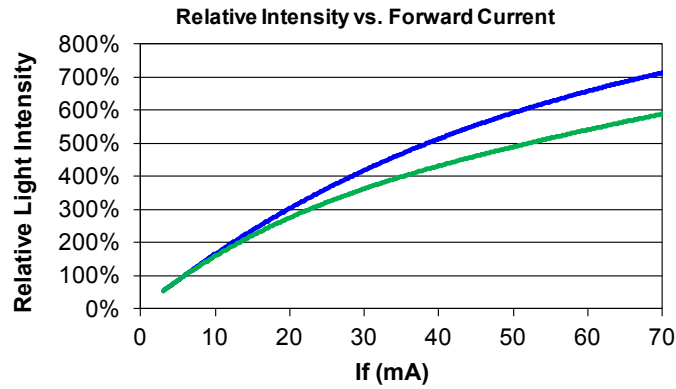

Radiation Pattern

This is a representative radiation pattern for the UltraThin Chip LED product. Actual patterns will vary slightly for each chip.

