

TOSHIBA Transistor Silicon NPN Epitaxial Planar Type

# 2SC4840

VHF~UHF Band Low Noise Amplifier Applications

Unit: mm

- Low noise figure, high gain.
- $NF = 1.1\text{dB}$ ,  $|S_{21e}|^2 = 13\text{dB}$  ( $f = 1\text{GHz}$ )

### Maximum Ratings ( $T_a = 25^\circ\text{C}$ )

Characteristics	Symbol	Rating	Unit
Collector-base voltage	$V_{CBO}$	20	V
Collector-emitter voltage	$V_{CEO}$	10	V
Emitter-base voltage	$V_{EBO}$	1.5	V
Base current	$I_B$	20	mA
Collector current	$I_C$	40	mA
Collector power dissipation	$P_C$	100	mW
Junction temperature	$T_j$	125	$^\circ\text{C}$
Storage temperature range	$T_{stg}$	-55~125	$^\circ\text{C}$

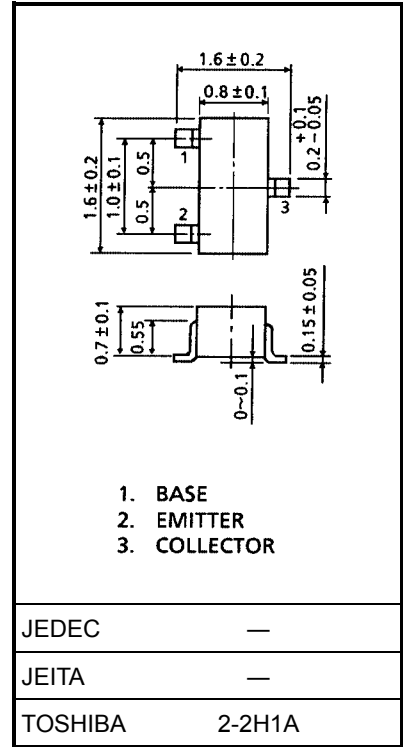

### Microwave Characteristics ( $T_a = 25^\circ\text{C}$ )

Weight: 2.4 mg (typ.)

Characteristics	Symbol	Test Condition	Min	Typ.	Max	Unit
Transition frequency	$f_T$	$V_{CE} = 8\text{V}$ , $I_C = 20\text{mA}$	7	10	—	GHz
Insertion gain	$ S_{21e} ^2$ (1)	$V_{CE} = 8\text{V}$ , $I_C = 20\text{mA}$ , $f = 1\text{GHz}$	10	13	—	dB
	$ S_{21e} ^2$ (2)	$V_{CE} = 8\text{V}$ , $I_C = 20\text{mA}$ , $f = 2\text{GHz}$	—	7	—	
Noise figure	NF (1)	$V_{CE} = 8\text{V}$ , $I_C = 5\text{mA}$ , $f = 1\text{GHz}$	—	1.1	2.5	dB
	NF (2)	$V_{CE} = 8\text{V}$ , $I_C = 5\text{mA}$ , $f = 2\text{GHz}$	—	1.7	—	

### Electrical Characteristics ( $T_a = 25^\circ\text{C}$ )

Characteristics	Symbol	Test Condition	Min	Typ.	Max	Unit
Collector cut-off current	$I_{CBO}$	$V_{CB} = 10\text{V}$ , $I_E = 0$	—	—	1	$\mu\text{A}$
Emitter cut-off current	$I_{EBO}$	$V_{EB} = 1\text{V}$ , $I_C = 0$	—	—	1	$\mu\text{A}$
DC current gain	$h_{FE}$	$V_{CE} = 8\text{V}$ , $I_C = 20\text{mA}$	50	—	250	
Output capacitance	$C_{ob}$	$V_{CB} = 10\text{V}$ , $I_E = 0$ , $f = 1\text{MHz}$ (Note)	—	0.6	—	pF
Reverse transfer capacitance	$C_{re}$		—	0.45	0.9	pF

Note:  $C_{re}$  is measured by 3 terminal method with capacitance bridge.

**Marking**

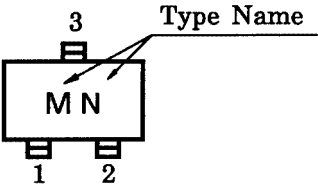

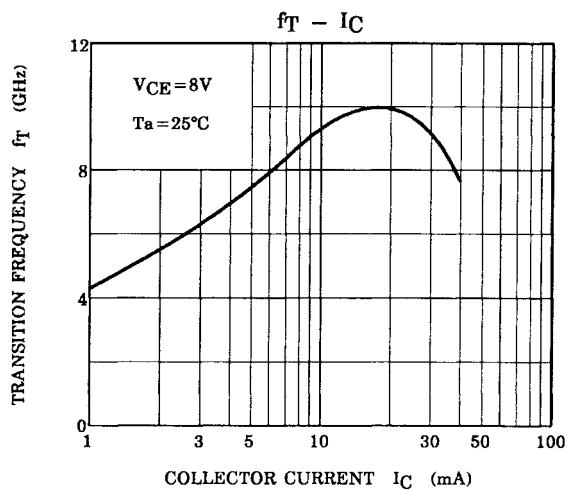
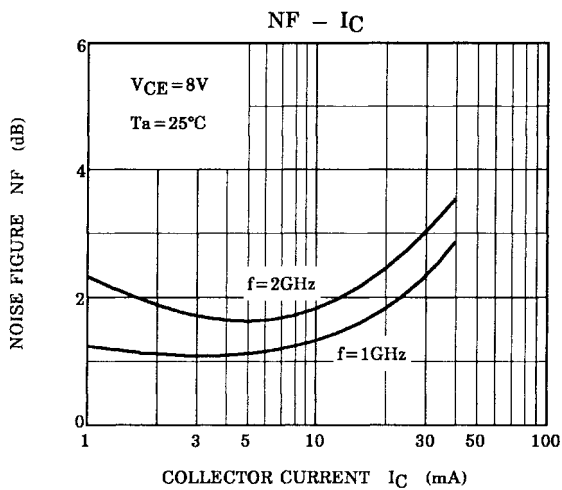
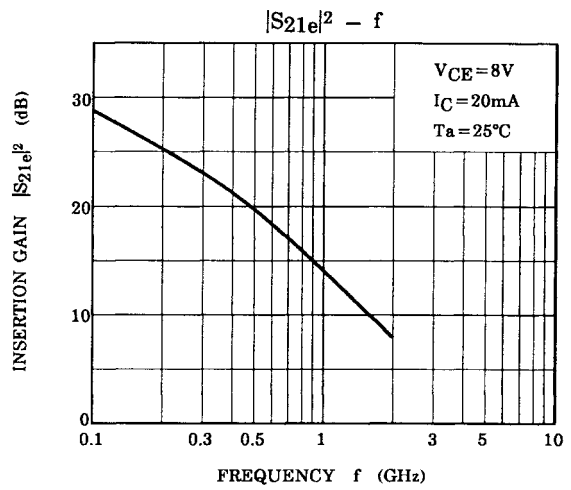
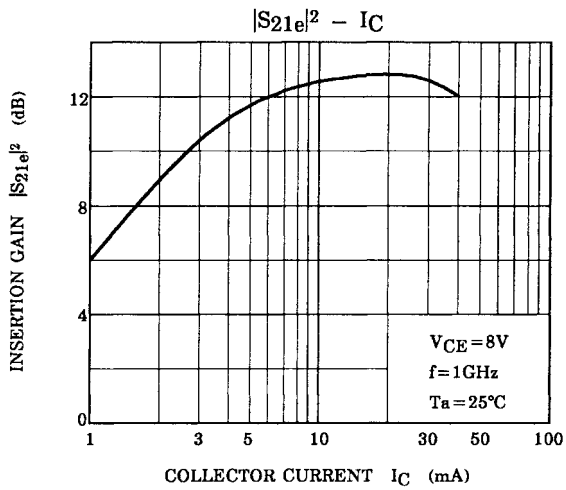
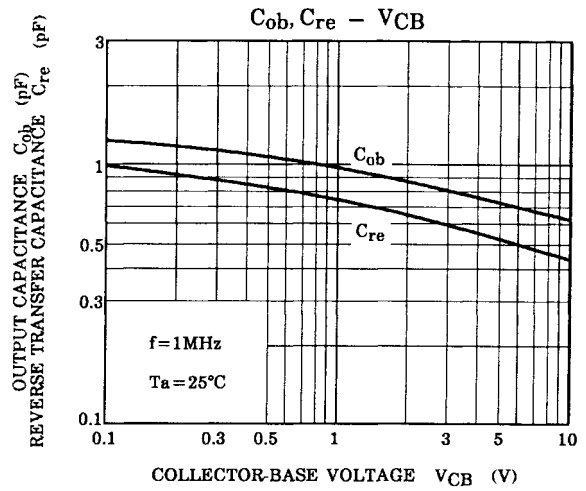
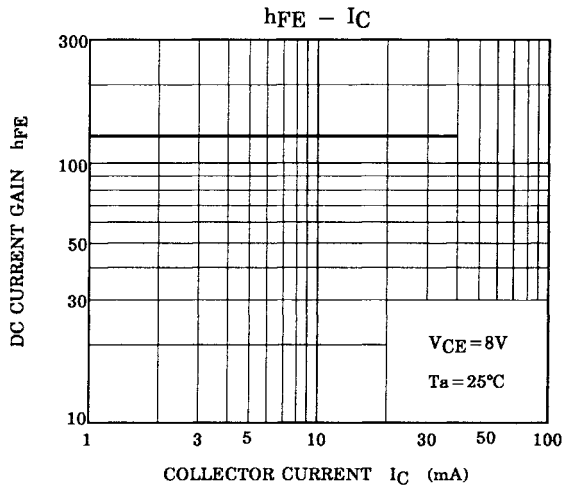

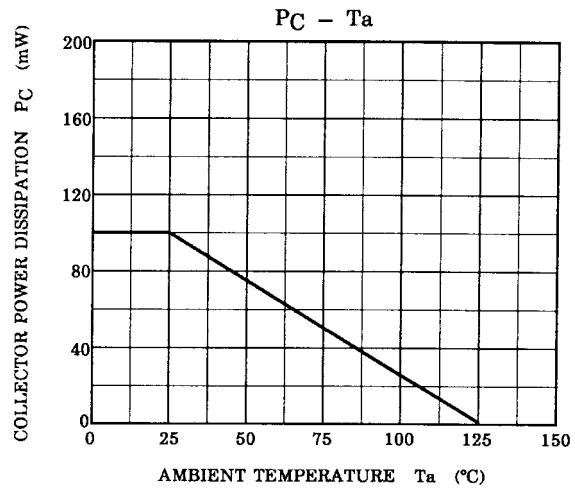
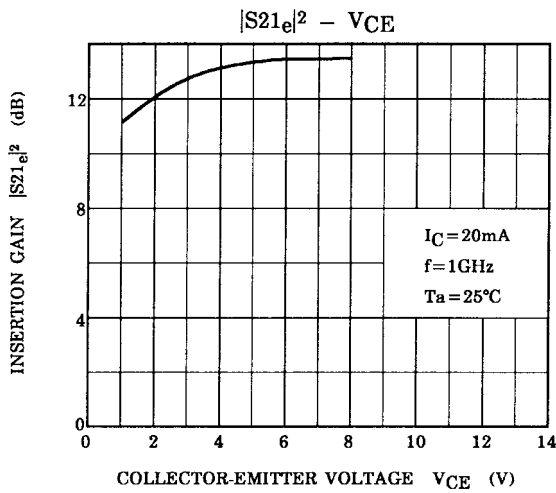

### S-Parameter $Z_O = 50 \Omega$ , $T_a = 25^\circ\text{C}$

**$V_{CE} = 8 \text{ V}$ ,  $I_C = 5 \text{ mA}$**

Frequency MHz	S11		S21		S12		S22	
	MAG	ANG	MAG	ANG	MAG	ANG	MAG	ANG
200	0.710	-49.8	10.366	140.1	0.043	63.4	0.805	-24.9
400	0.513	-85.6	7.744	118.2	0.063	55.6	0.609	-32.5
600	0.400	-109.8	5.844	105.6	0.076	55.0	0.507	-33.3
800	0.347	-126.2	4.634	97.8	0.087	57.4	0.456	-32.4
1000	0.319	-138.6	3.851	91.9	0.099	60.2	0.427	-31.8
1200	0.303	-148.0	3.310	87.4	0.112	62.9	0.411	-31.5
1400	0.299	-155.5	2.914	83.3	0.126	64.4	0.401	-32.6
1600	0.294	-160.5	2.610	80.0	0.139	65.9	0.389	-33.8
1800	0.296	-160.3	2.367	77.4	0.153	68.7	0.380	-34.8
2000	0.300	-163.9	2.184	75.0	0.171	69.3	0.376	-36.4

**$V_{CE} = 8 \text{ V}$ ,  $I_C = 20 \text{ mA}$**

Frequency MHz	S11		S21		S12		S22	
	MAG	ANG	MAG	ANG	MAG	ANG	MAG	ANG
200	0.383	-98.8	19.474	117.1	0.043	63.5	0.538	-34.2
400	0.292	-134.7	10.899	100.9	0.063	55.5	0.384	-30.2
600	0.270	-154.3	7.496	93.5	0.076	55.0	0.341	-25.5
800	0.262	-165.3	5.727	88.7	0.087	57.3	0.327	-22.9
1000	0.256	-173.1	4.663	84.6	0.099	60.1	0.321	-21.8
1200	0.254	-178.3	3.972	81.4	0.112	62.7	0.322	-22.3
1400	0.257	178.1	3.462	78.3	0.126	64.4	0.320	-23.7
1600	0.258	176.3	3.088	75.7	0.138	66.0	0.315	-25.3
1800	0.258	176.5	2.786	73.7	0.153	68.5	0.314	-26.2
2000	0.265	177.7	2.569	71.6	0.171	69.4	0.308	-28.3

S11e  
 VCE=8V  
 IC=5mA  
 Ta=25°C  
 (UNIT : Ω)

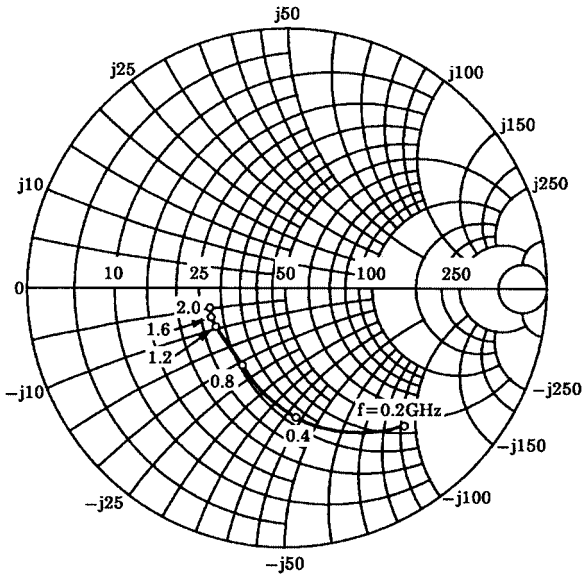

S21e  
 VCE=8V  
 IC=5mA  
 Ta=25°C

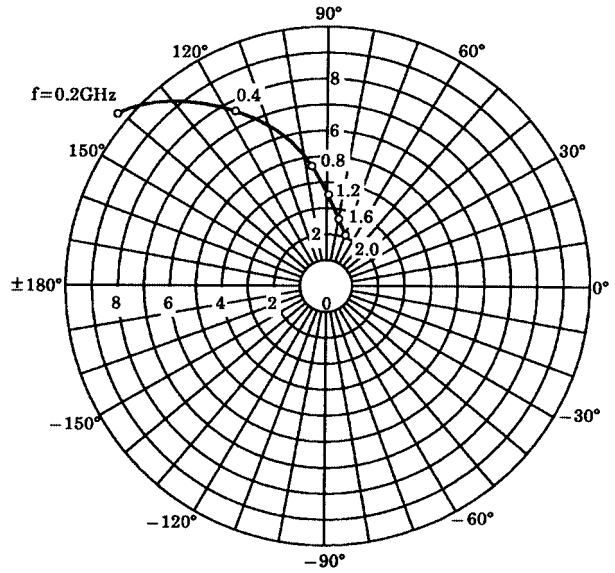

S12e  
 VCE=8V  
 IC=5mA  
 Ta=25°C

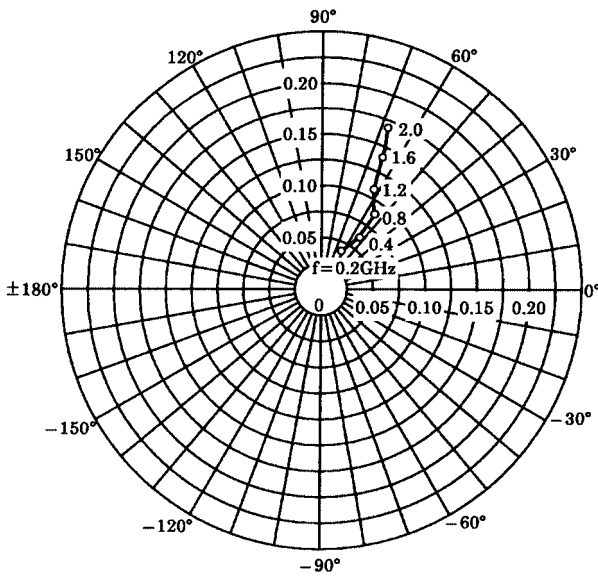

S22e  
 VCE=8V  
 IC=5mA  
 Ta=25°C  
 (UNIT : Ω)

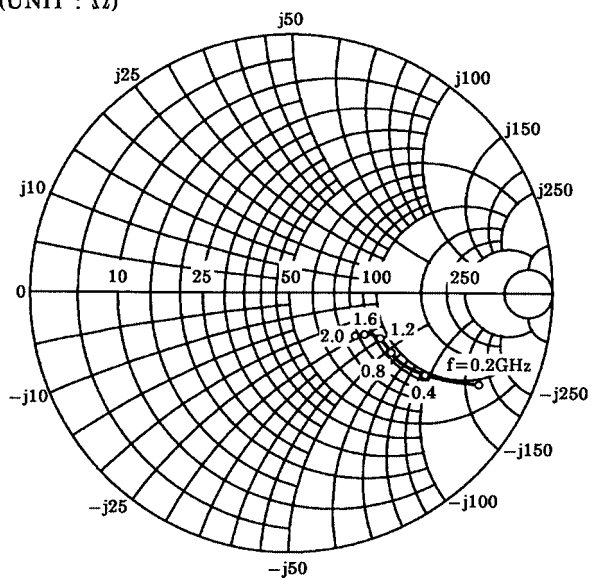

S11e  
 VCE=8V  
 IC=20mA  
 Ta=25°C  
 (UNIT : Ω)

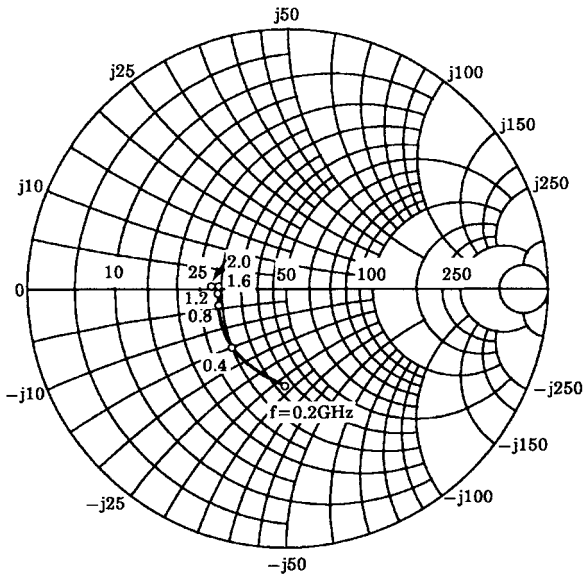

S21e  
 VCE=8V  
 IC=20mA  
 Ta=25°C

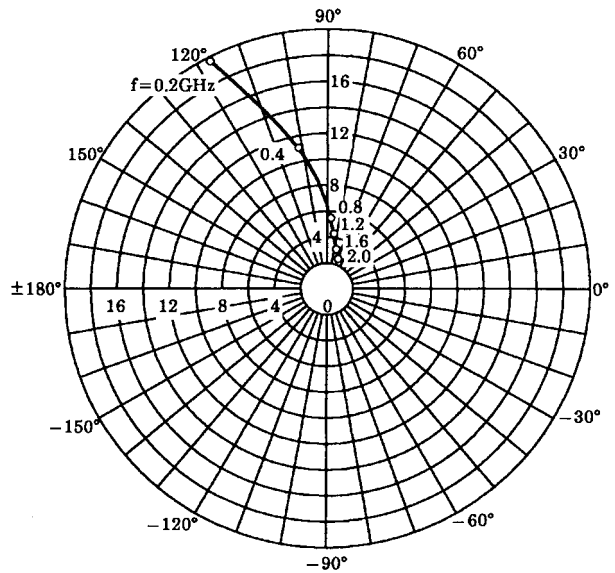

S12e  
 VCE=8V  
 IC=20mA  
 Ta=25°C

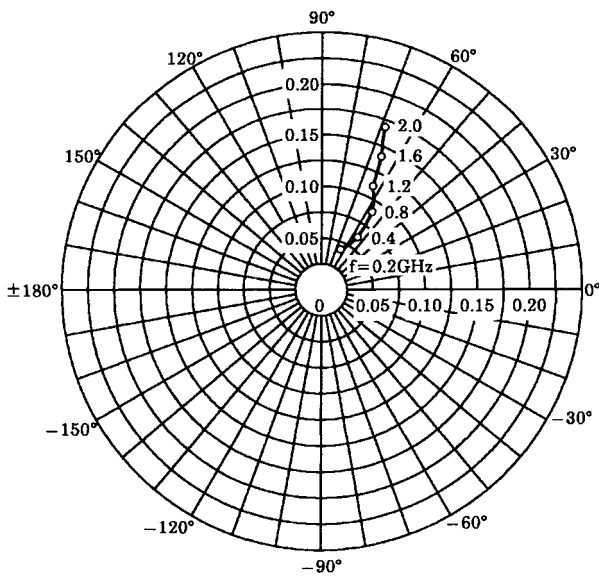

S22e  
 VCE=8V  
 IC=20mA  
 Ta=25°C  
 (UNIT : Ω)

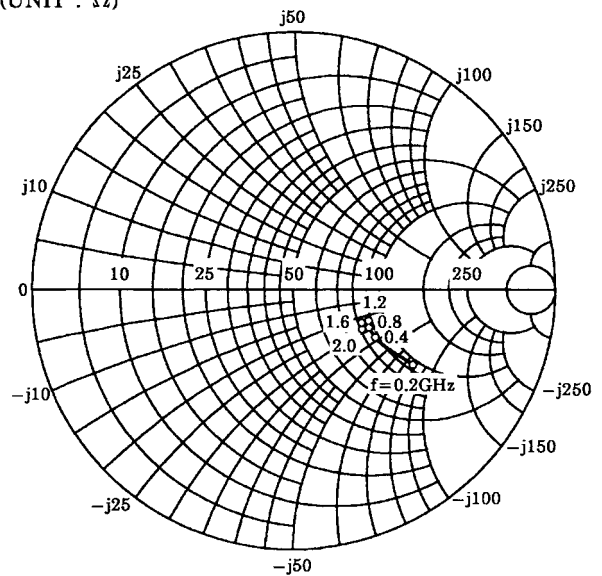

**RESTRICTIONS ON PRODUCT USE**

000707EAA

- TOSHIBA is continually working to improve the quality and reliability of its products. Nevertheless, semiconductor devices in general can malfunction or fail due to their inherent electrical sensitivity and vulnerability to physical stress. It is the responsibility of the buyer, when utilizing TOSHIBA products, to comply with the standards of safety in making a safe design for the entire system, and to avoid situations in which a malfunction or failure of such TOSHIBA products could cause loss of human life, bodily injury or damage to property.  
In developing your designs, please ensure that TOSHIBA products are used within specified operating ranges as set forth in the most recent TOSHIBA products specifications. Also, please keep in mind the precautions and conditions set forth in the "Handling Guide for Semiconductor Devices," or "TOSHIBA Semiconductor Reliability Handbook" etc..
- The TOSHIBA products listed in this document are intended for usage in general electronics applications (computer, personal equipment, office equipment, measuring equipment, industrial robotics, domestic appliances, etc.). These TOSHIBA products are neither intended nor warranted for usage in equipment that requires extraordinarily high quality and/or reliability or a malfunction or failure of which may cause loss of human life or bodily injury ("Unintended Usage"). Unintended Usage include atomic energy control instruments, airplane or spaceship instruments, transportation instruments, traffic signal instruments, combustion control instruments, medical instruments, all types of safety devices, etc.. Unintended Usage of TOSHIBA products listed in this document shall be made at the customer's own risk.
- The information contained herein is presented only as a guide for the applications of our products. No responsibility is assumed by TOSHIBA CORPORATION for any infringements of intellectual property or other rights of the third parties which may result from its use. No license is granted by implication or otherwise under any intellectual property or other rights of TOSHIBA CORPORATION or others.
- The information contained herein is subject to change without notice.