

Silicon NPN Power Transistors

2SC4881

DESCRIPTION

- With TO-220F package
- Low saturation voltage
- High speed switching time

APPLICATIONS

- High current switching applications

PINNING

PIN	DESCRIPTION
1	Base
2	Collector
3	Emitter

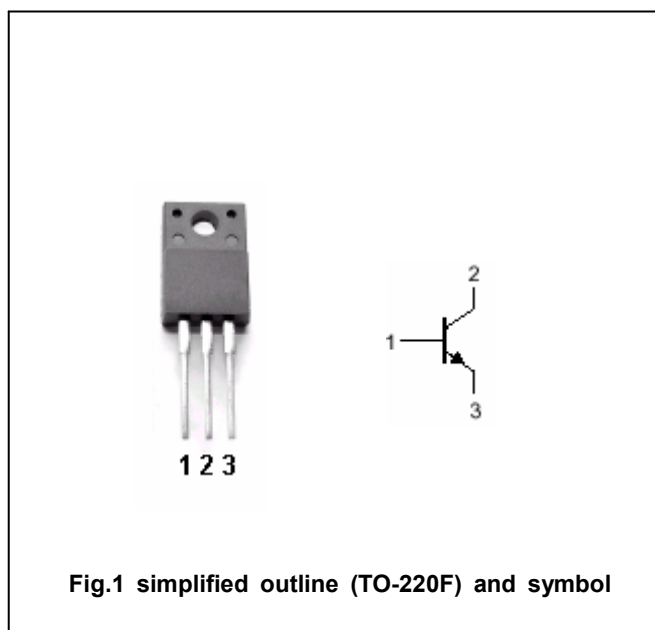
Absolute maximum ratings($T_a=25^\circ\text{C}$)

SYMBOL	PARAMETER	CONDITIONS	VALUE	UNIT
V_{CBO}	Collector-base voltage	Open emitter	60	V
V_{CEO}	Collector-emitter voltage	Open base	50	V
V_{EBO}	Emitter-base voltage	Open collector	5	V
I_C	Collector current		5	A
I_{CM}	Collector current-Peak		8	A
I_B	Base current		1	A
P_C	Collector power dissipation	$T_a=25^\circ\text{C}$	2.0	W
		$T_c=25^\circ\text{C}$	20	
T_j	Junction temperature		150	$^\circ\text{C}$
T_{stg}	Storage temperature		-55~150	$^\circ\text{C}$

Silicon NPN Power Transistors

2SC4881

CHARACTERISTICS

T_j=25°C unless otherwise specified

SYMBOL	PARAMETER	CONDITIONS	MIN	TYP.	MAX	UNIT
V _{(BR)CEO}	Collector-emitter breakdown voltage	I _C =10mA ; I _B =0	50			V
V _{CEsat}	Collector-emitter saturation voltage	I _C =2.5A; I _B =0.125A			0.4	V
V _{BEsat}	Base-emitter saturation voltage	I _C =2.5A; I _B =0.125A			1.3	V
I _{CBO}	Collector cut-off current	V _{CB} =50V; I _E =0			1	μA
I _{EBO}	Emitter cut-off current	V _{EB} =6V; I _C =0			1	μA
h _{FE-1}	DC current gain	I _C =1A ; V _{CE} =1V	100		320	
h _{FE-2}	DC current gain	I _C =2.5A ; V _{CE} =1V	60			
f _T	Transition frequency	I _C =1A ; V _{CE} =4V		100		MHz
C _{OB}	Collector output capacitance	I _E =0; f=1MHz; V _{CB} =10V		45		pF

Switching times

t _{on}	Turn-on time	I _C =2.5A I _{B1} =-I _{B2} =0.125A V _{CC} =30V ,R _L =12Ω Duty cycle≤1%		0.1		μs
t _s	Storage time			0.8		μs
t _f	Fall time			0.1		μs

Silicon NPN Power Transistors

2SC4881

PACKAGE OUTLINE

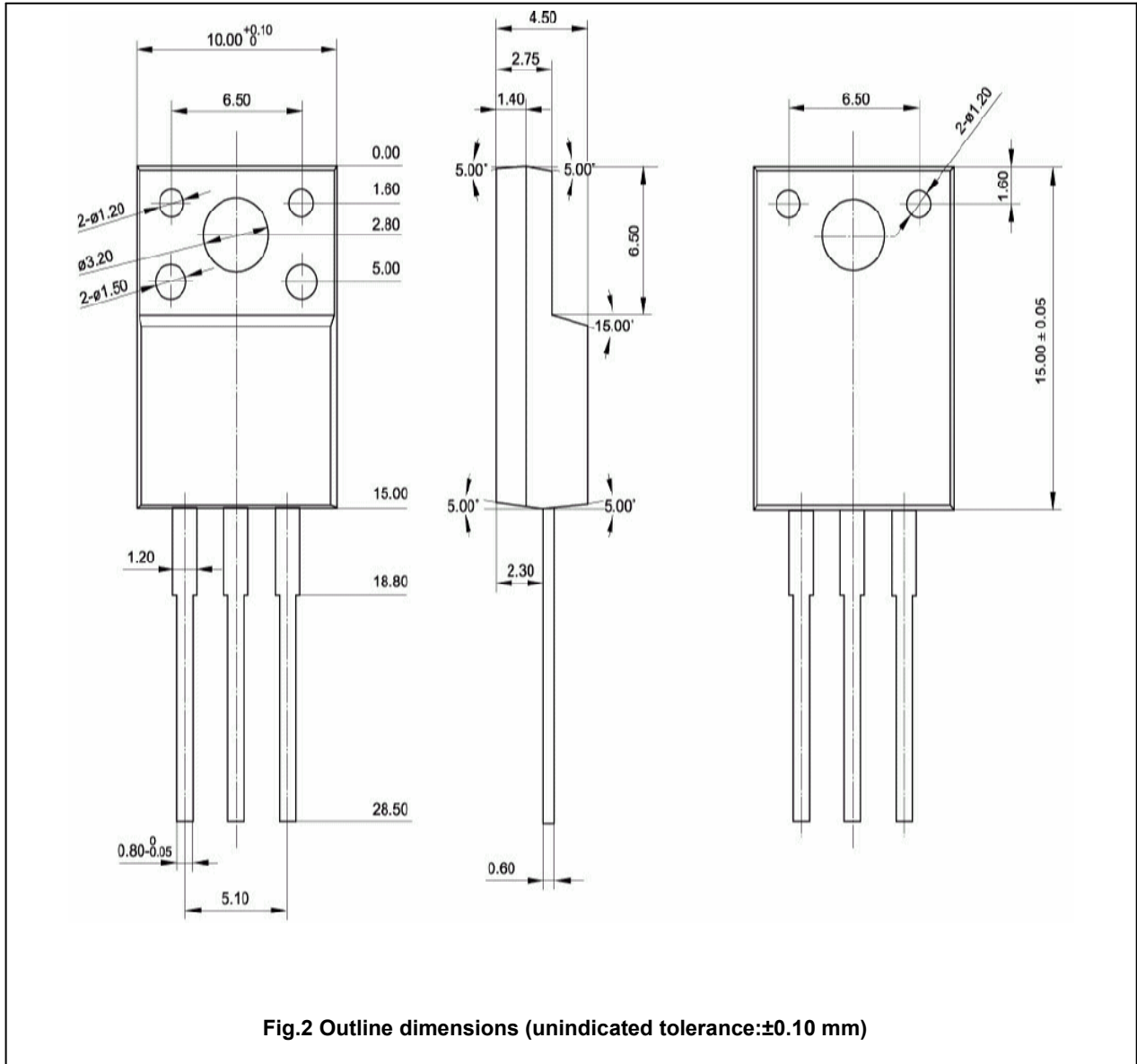

Fig.2 Outline dimensions (unindicated tolerance: ± 0.10 mm)

Silicon NPN Power Transistors

2SC4881

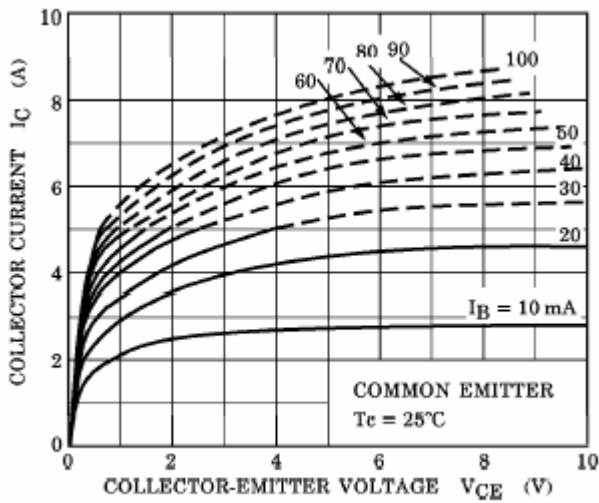

Fig.3 Static Characteristic

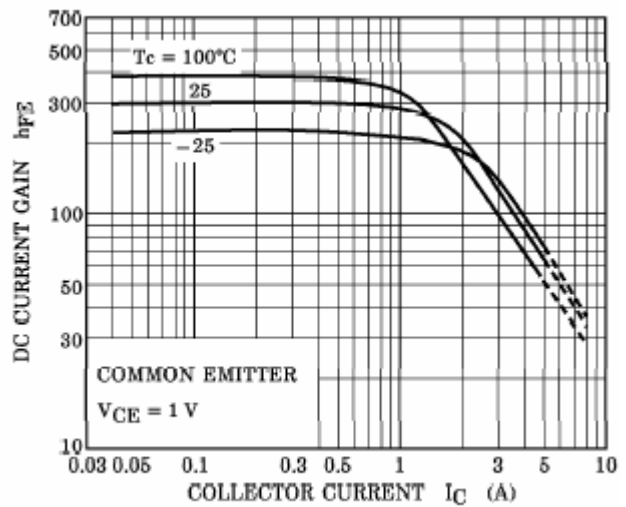

Fig.4 DC current Gain

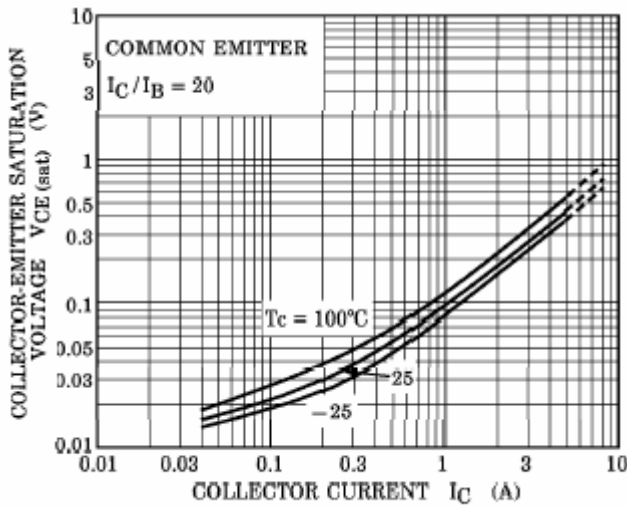

Fig.5 Collector-Emitter Saturation Voltage

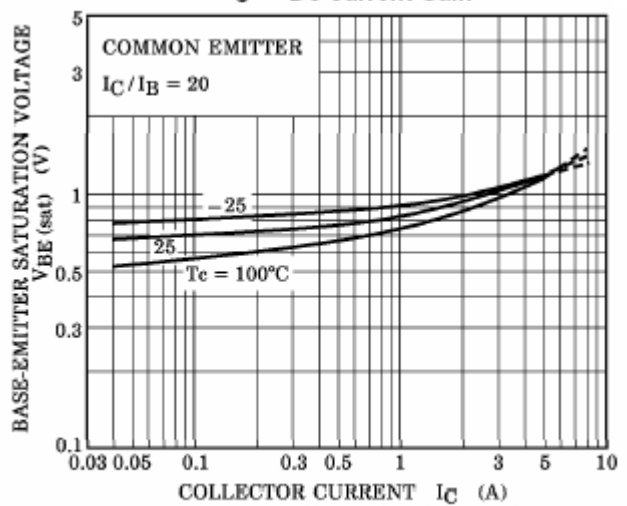

Fig.6 Base-Emitter Saturation Voltage

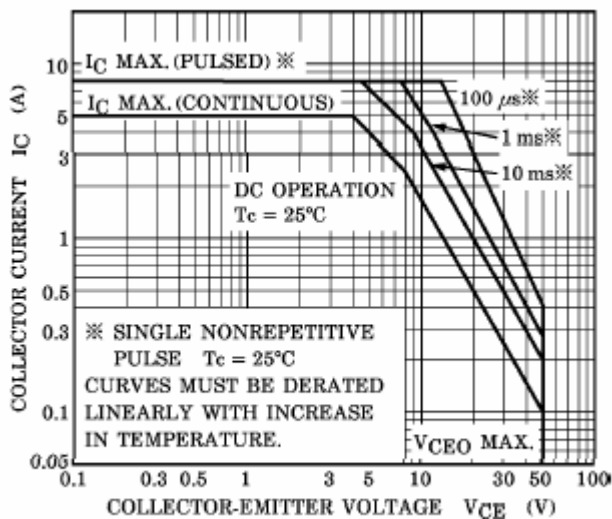

Fig.7 Safe Operating Area