

# C4D30120D–Silicon Carbide Schottky Diode

## Z-REC™ RECTIFIER

$V_{RRM}$	=	1200 V
$I_F, T_c < 135^\circ\text{C}$	=	43 A
$Q_c$	=	192 nC

### Features

- 1.2kV Schottky Rectifier
- Zero Reverse Recovery Current
- High-Frequency Operation
- Temperature-Independent Switching
- Extremely Fast Switching

### Benefits

- Replace Bipolar with Unipolar Rectifiers
- Essentially No Switching Losses
- Higher Efficiency
- Reduction of Heat Sink Requirements
- Parallel Devices Without Thermal Runaway

### Applications

- Switch Mode Power Supplies
- Power Factor Correction
- Motor Drives

### Package

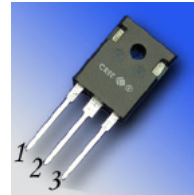

TO-247-3

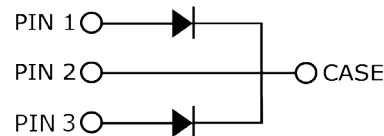

Part Number	Package	Marking
C4D30120D	TO-247-3	C4D30120

### Maximum Ratings ( $T_c=25^\circ\text{C}$ unless otherwise specified)

Symbol	Parameter	Value	Unit	Test Conditions	Note
$V_{RRM}$	Repetitive Peak Reverse Voltage	1200	V		
$V_{RSM}$	Surge Peak Reverse Voltage	1300	V		
$V_R$	DC Peak Reverse Voltage	1200	V		
$I_F$	Continuous DC Current (Per Leg/Device)	21.5/43	A	$T_c=135^\circ\text{C}$ , no AC component	
$I_{FRM}$	Repetitive Peak Forward Surge Current	68* 44*	A	$T_c=25^\circ\text{C}$ , $t_p=10$ ms, Half Sine Pulse $T_c=110^\circ\text{C}$ , $t_p=10$ ms, Half Sine Pulse	
$I_{FSM}$	Non-Repetitive Forward Surge Current	130* 117*	A	$T_c=25^\circ\text{C}$ , $t_p=10$ ms, Half Sine Pulse $T_c=110^\circ\text{C}$ , $t_p=10$ ms, Half Sine Pulse	
$P_{tot}$	Power Dissipation (Per Leg/Device)	220/440 95/190	W	$T_c=25^\circ\text{C}$ $T_c=110^\circ\text{C}$	
$T_c$	Maximum Case Temperature	135	$^\circ\text{C}$		
$T_j$	Operating Junction Range	-55 to +175	$^\circ\text{C}$		
$T_{stg}$	Storage Temperature Range	-55 to +135	$^\circ\text{C}$		
	TO-247 Mounting Torque	1 8.8	Nm lbf-in	M3 Screw 6-32 Screw	

\*\* Per Device, \* Per Leg

### Electrical Characteristics

Symbol	Parameter	Typ.	Max.	Unit	Test Conditions	Note
$V_F$	Forward Voltage	1.6 2.3	1.8 3	V	$I_F = 15\text{ A } T_J = 25^\circ\text{C}$ $I_F = 15\text{ A } T_J = 175^\circ\text{C}$	
$I_R$	Reverse Current	35 120	200 300	$\mu\text{A}$	$V_R = 1200\text{ V } T_J = 25^\circ\text{C}$ $V_R = 1200\text{ V } T_J = 175^\circ\text{C}$	
$Q_C$	Total Capacitive Charge	96		nC	$V_R = 1200\text{ V}, I_F = 15\text{ A}$ $di/dt = 200\text{ A}/\mu\text{s}$ $T_J = 25^\circ\text{C}$	
C	Total Capacitance	1200 70 50		pF	$V_R = 0\text{ V}, T_J = 25^\circ\text{C}, f = 1\text{ MHz}$ $V_R = 400\text{ V}, T_J = 25^\circ\text{C}, f = 1\text{ MHz}$ $V_R = 800\text{ V}, T_J = 25^\circ\text{C}, f = 1\text{ MHz}$	

1. Note: This is a majority carrier diode, so there is no reverse recovery charge.

### Thermal Characteristics

Symbol	Parameter	Typ.	Max.	Unit	Test Conditions	Note
$R_{\theta JC}$	Thermal Resistance from Junction to Case	0.34** 0.68*		$^\circ\text{C}/\text{W}$		

\*\* Per Device, \* Per Leg

### Typical Performance (Per Leg)

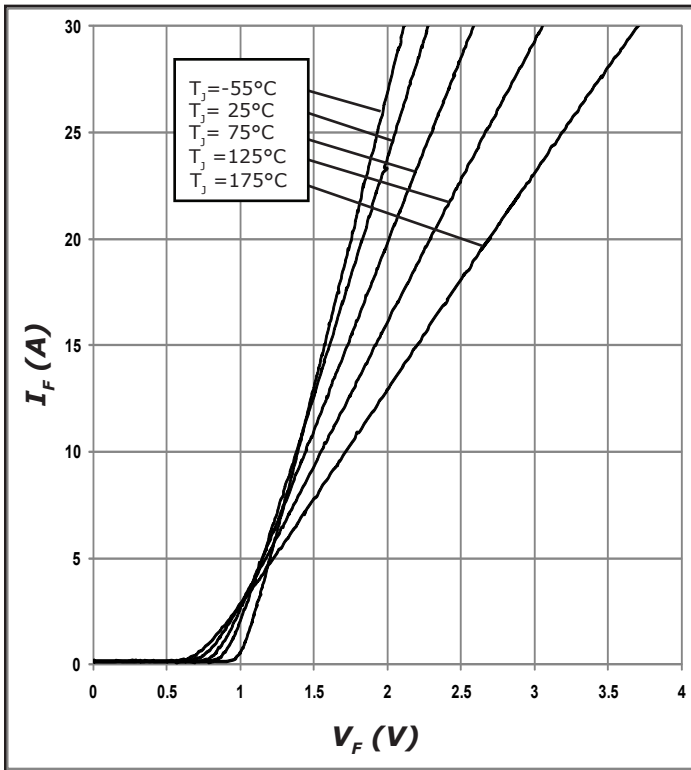

Figure 1. Forward Characteristics

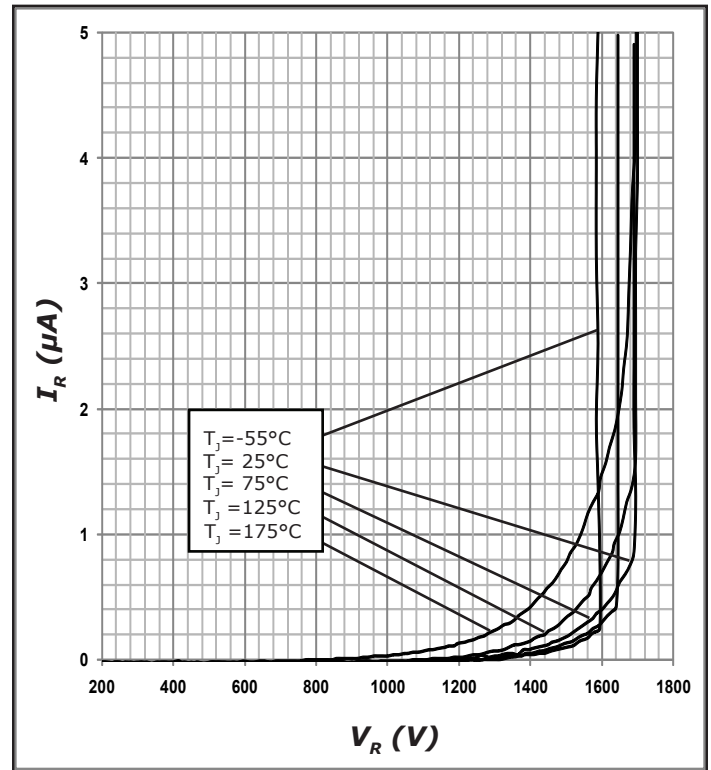

Figure 2. Reverse Characteristics

### Typical Performance (Per Leg)

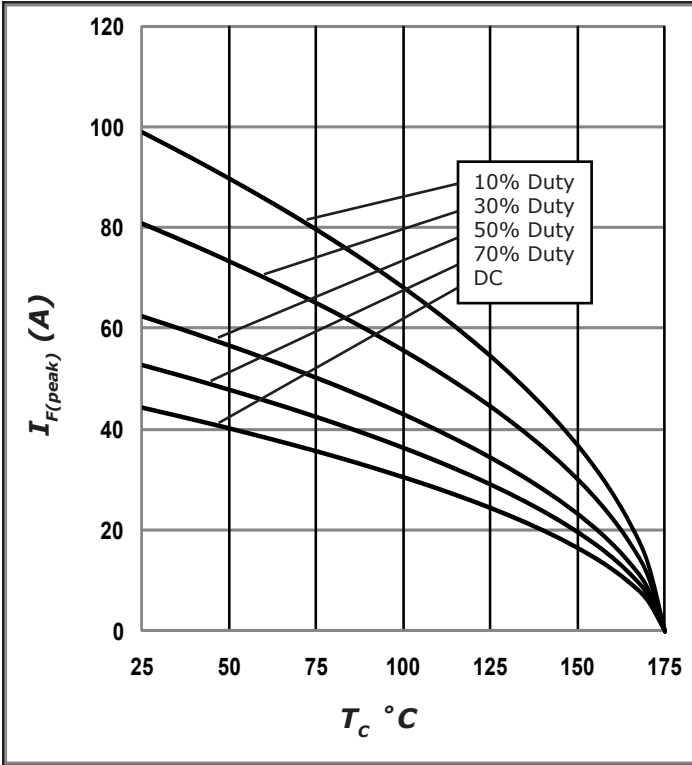

Figure 3. Current Derating

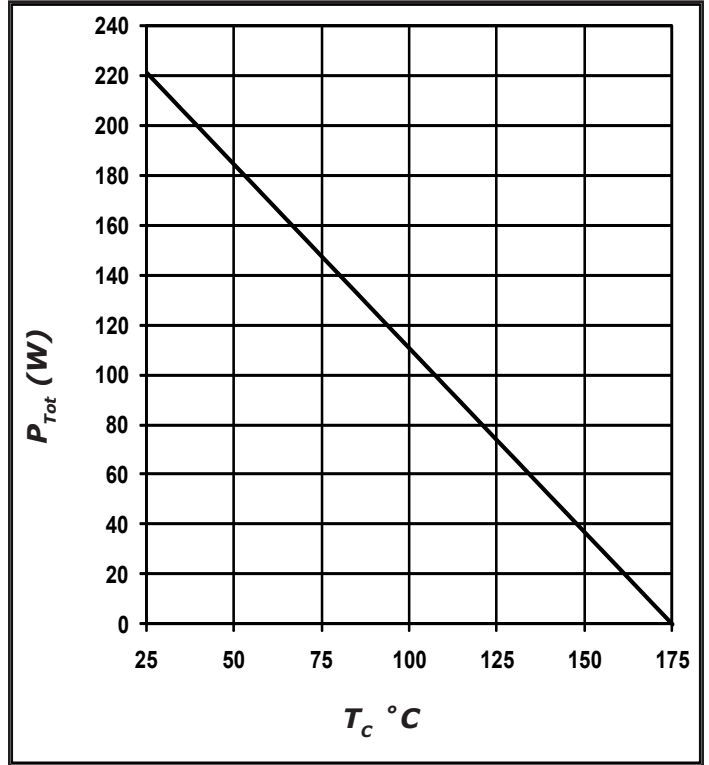

Figure 4. Power Derating

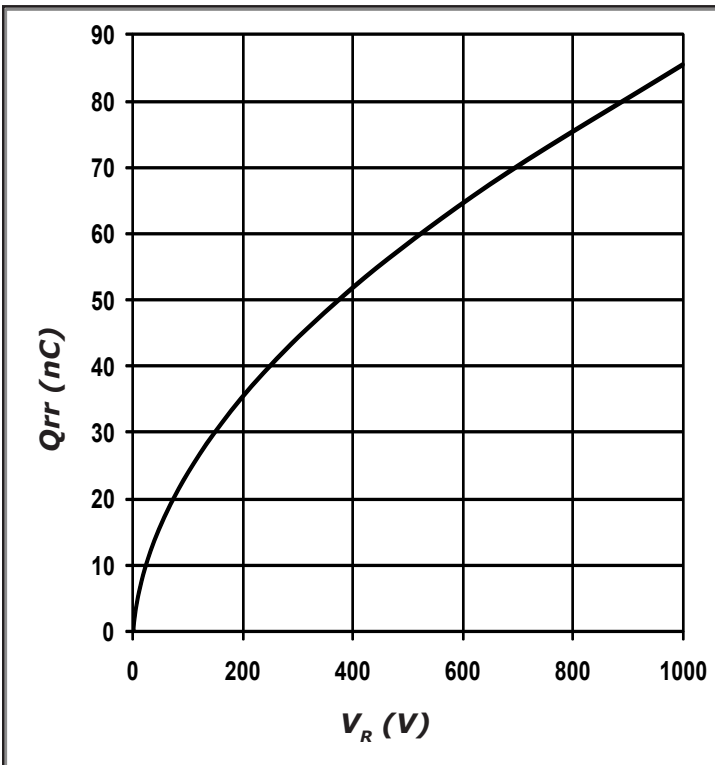

Figure 5. Recovery Charge vs. Reverse Voltage

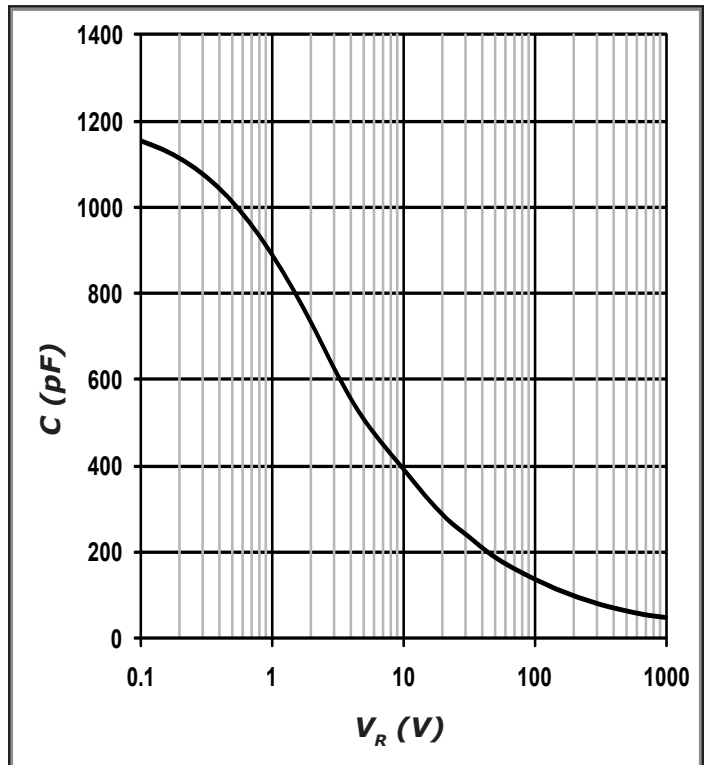

Figure 6. Capacitance vs. Reverse Voltage

## Typical Performance (Per Leg )

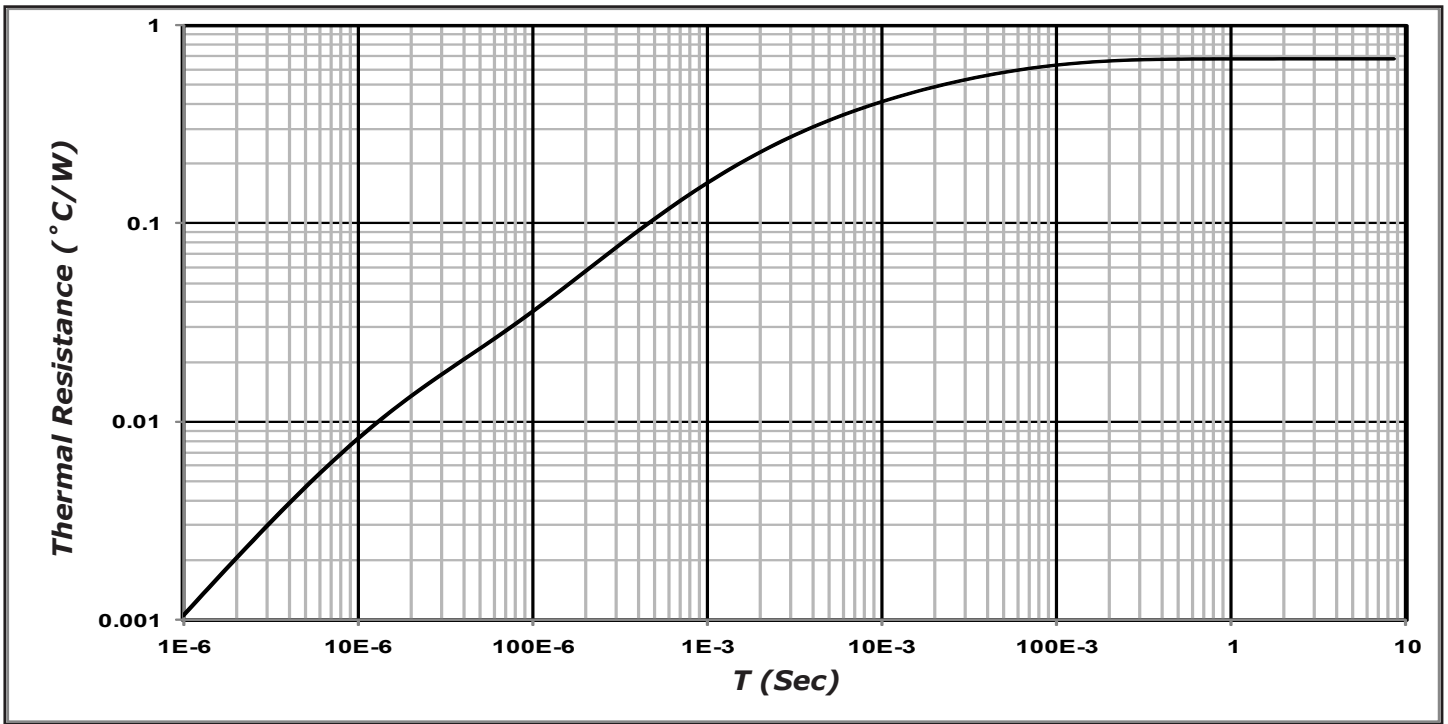
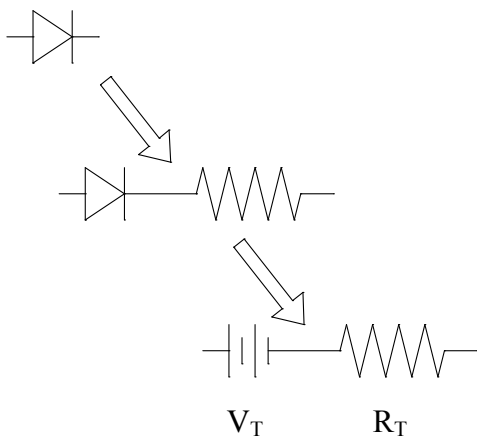

Figure 7. Transient Thermal Impedance

## Diode Model



$$Vf_T = V_T + If * R_T$$

$$V_T = 0.97 + (T_j * -2.12 * 10^{-3})$$

$$R_T = 0.031 + (T_j * 3.92 * 10^{-4})$$

Note:  $T_j$  is diode junction temperature in degrees Celsius

## Package Dimensions

Package TO-247-3

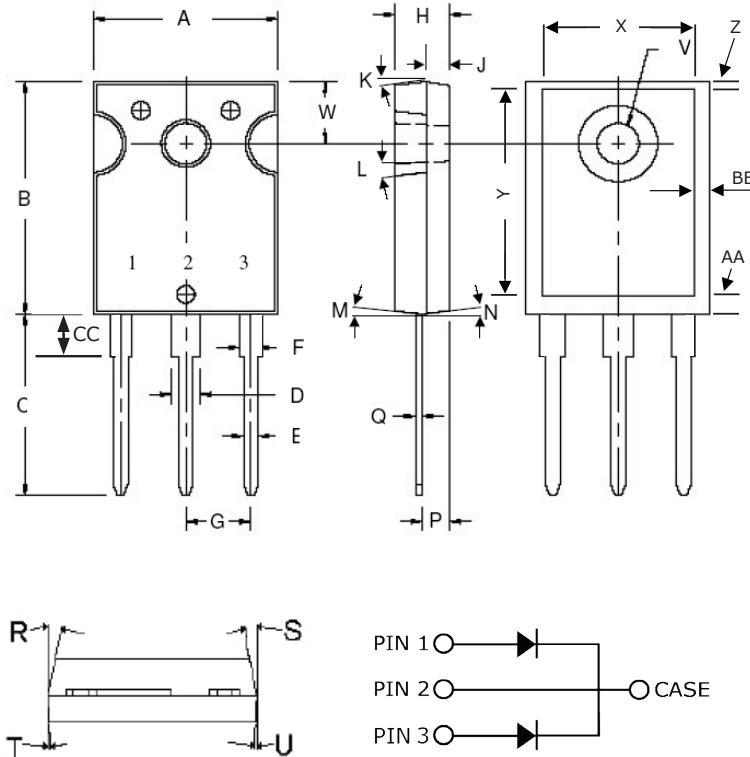

POS	Inches		Millimeters	
	Min	Max	Min	Max
A	.605	.635	15.367	16.130
B	.800	.831	20.320	21.10
C	.780	.800	19.810	20.320
D	.095	.133	2.413	3.380
E	.046	.052	1.168	1.321
F	.060	.095	1.524	2.410
G	.215 TYP		5.460 TYP	
H	.175	.205	4.450	5.210
J	.075	.085	1.910	2.160
K	6°	21°	6°	21°
L	4°	6°	4°	6°
M	2°	4°	2°	4°
N	2°	4°	2°	4°
P	.090	.100	2.286	2.540
Q	.020	.030	.508	.762
R	9°	11°	9°	11°
S	9°	11°	9°	11°
T	2°	8°	2°	8°
U	2°	8°	2°	8°
V	.137	.144	3.487	3.658
W	.210	.248	5.334	6.300
X	.502	.557	12.751	14.150
Y	.637	.695	16.180	17.653
Z	.038	.052	0.964	1.321
AA	.110	.140	2.794	3.556
BB	.030	.046	0.766	1.168
CC	.161	.176	4.100	4.472

## Recommended Solder Pad Layout

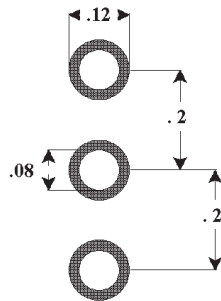

TO-247-3

Part Number	Package	Marking
C4D30120D	TO-247-3	C4D30120

"The levels of environmentally sensitive, persistent biologically toxic (PBT), persistent organic pollutants (POP), or otherwise restricted materials in this product are below the maximum concentration values (also referred to as the threshold limits) permitted for such substances, or are used in an exempted application, in accordance with EU Directive 2002/95/EC on the restriction of the use of certain hazardous substances in electrical and electronic equipment (RoHS), as amended through April 21, 2006."

This product has not been designed or tested for use in, and is not intended for use in, applications implanted into the human body nor in applications in which failure of the product could lead to death, personal injury or property damage, including but not limited to equipment used in the operation of nuclear facilities, life-support machines, cardiac defibrillators or similar emergency medical equipment, aircraft navigation or communication or control systems, air traffic control systems, or weapons systems.

Copyright © 2012 Cree, Inc. All rights reserved. The information in this document is subject to change without notice. Cree, the Cree logo, and Zero Recovery are registered trademarks of Cree, Inc.

Cree, Inc.  
4600 Silicon Drive  
Durham, NC 27703  
USA Tel: +1.919.313.5300  
Fax: +1.919.313.5451  
www.cree.com/power