

TOSHIBA Transistor Silicon NPN Epitaxial Planar Type

# 2SC5094

## VHF~UHF Band Low Noise Amplifier Applications

Unit: mm

- Low noise figure, high gain.
- $NF = 1.8\text{dB}$ ,  $|S_{21e}|^2 = 7.5\text{dB}$  ( $f = 2\text{GHz}$ )

### Maximum Ratings ( $T_a = 25^\circ\text{C}$ )

Characteristics	Symbol	Rating	Unit
Collector-base voltage	$V_{CBO}$	20	V
Collector-emitter voltage	$V_{CEO}$	10	V
Emitter-base voltage	$V_{EBO}$	1.5	V
Base current	$I_B$	7	mA
Collector current	$I_C$	15	mA
Collector power dissipation	$P_C$	150	mW
Junction temperature	$T_j$	125	$^\circ\text{C}$
Storage temperature range	$T_{stg}$	-55~125	$^\circ\text{C}$

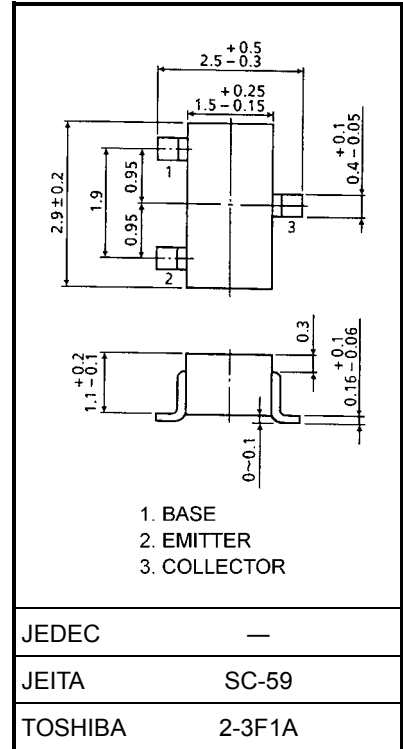

### Microwave Characteristics ( $T_a = 25^\circ\text{C}$ )

Weight: 0.012 g (typ.)

Characteristics	Symbol	Test Condition	Min	Typ.	Max	Unit
Transition frequency	$f_T$	$V_{CE} = 6\text{V}$ , $I_C = 7\text{mA}$	7	10	—	GHz
Insertion gain	$ S_{21e} ^2 (1)$	$V_{CE} = 6\text{V}$ , $I_C = 7\text{mA}$ , $f = 1\text{GHz}$	—	13	—	dB
	$ S_{21e} ^2 (2)$	$V_{CE} = 6\text{V}$ , $I_C = 7\text{mA}$ , $f = 2\text{GHz}$	4.5	7.5	—	
Noise figure	NF (1)	$V_{CE} = 6\text{V}$ , $I_C = 3\text{mA}$ , $f = 1\text{GHz}$	—	1.4	—	dB
	NF (2)	$V_{CE} = 6\text{V}$ , $I_C = 3\text{mA}$ , $f = 2\text{GHz}$	—	1.8	3.0	

### Electrical Characteristics ( $T_a = 25^\circ\text{C}$ )

Characteristics	Symbol	Test Condition	Min	Typ.	Max	Unit
Collector cut-off current	$I_{CBO}$	$V_{CB} = 10\text{V}$ , $I_E = 0$	—	—	1	$\mu\text{A}$
Emitter cut-off current	$I_{EBO}$	$V_{EB} = 1\text{V}$ , $I_C = 0$	—	—	1	$\mu\text{A}$
DC current gain	$h_{FE}$ (Note 1)	$V_{CE} = 6\text{V}$ , $I_C = 7\text{mA}$	50	—	160	
Output capacitance	$C_{ob}$	$V_{CB} = 10\text{V}$ , $I_E = 0$ , $f = 1\text{MHz}$ (Note 2)	—	0.5	—	pF
Reverse transfer capacitance	$C_{re}$		—	0.4	0.85	pF

Note 1:  $h_{FE}$  classification R: 50~100, O: 80~160

Note 2:  $C_{re}$  is measured by 3 terminal method with capacitance bridge.

**Marking**

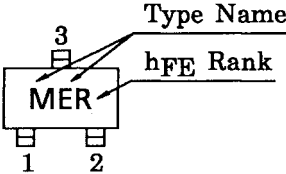

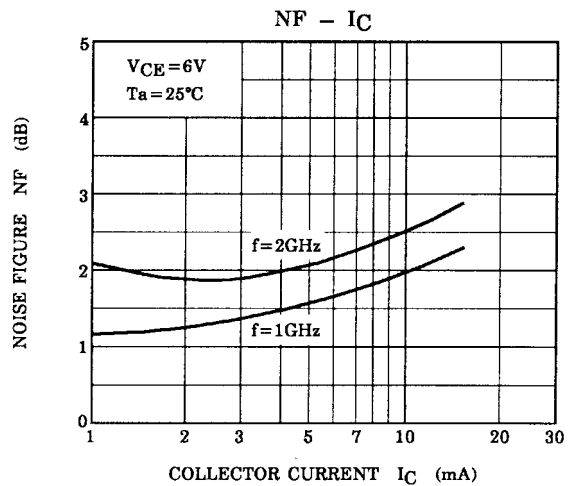
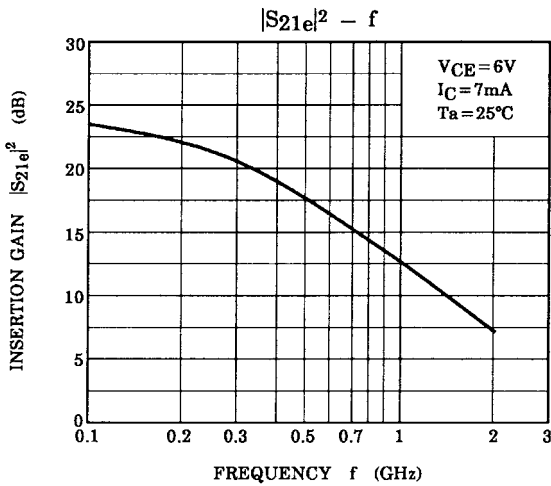
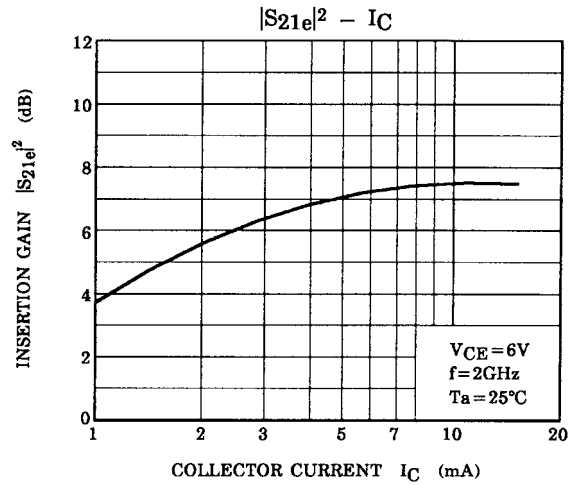
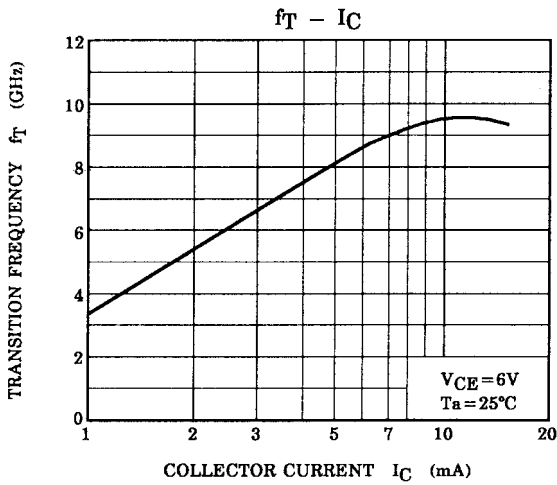
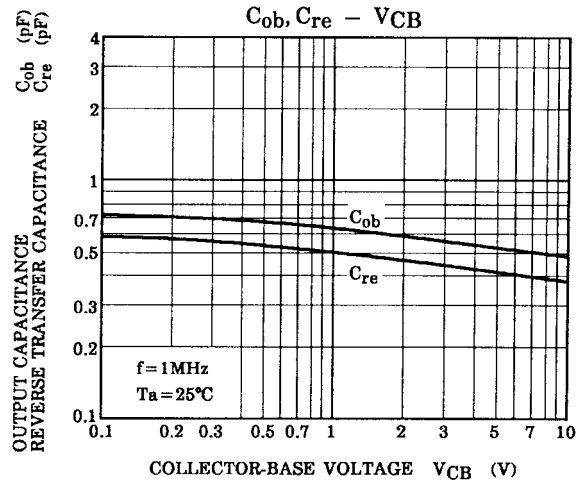
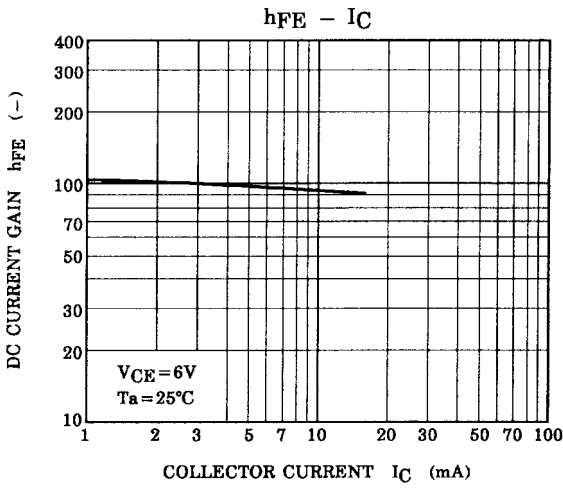

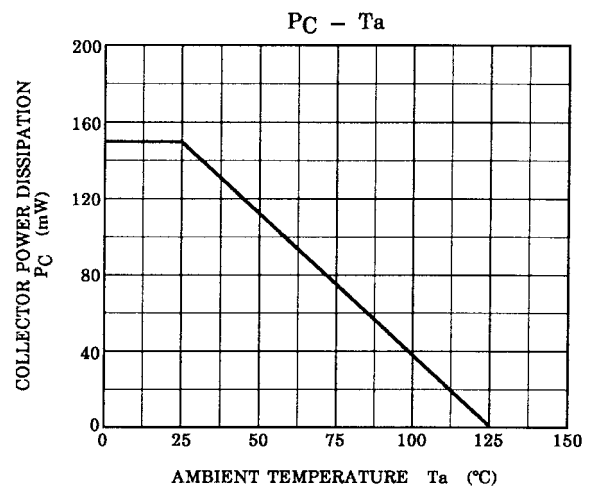
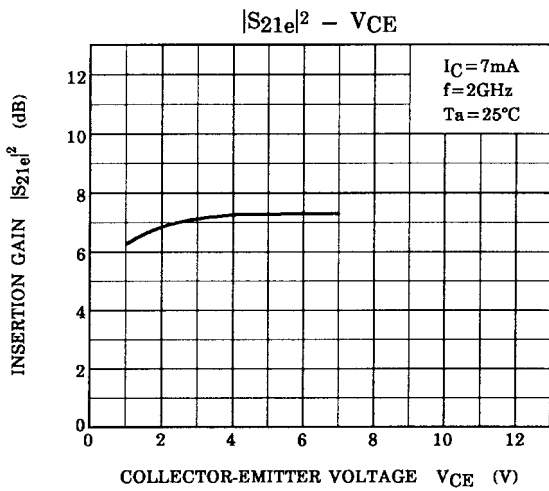

**S-Parameter  $Z_0 = 50 \Omega, T_a = 25^\circ C$**

**$V_{CE} = 6 V, I_C = 3 mA$**

Frequency (MHz)	S11		S21		S12		S22	
	Mag.	Ang.	Mag.	Ang.	Mag.	Ang.	Mag.	Ang.
200	0.817	-25.8	7.113	150.2	0.044	71.4	0.898	-18.6
400	0.647	-46.3	6.028	129.5	0.073	61.8	0.746	-28.7
600	0.477	-61.4	5.061	113.9	0.092	57.2	0.636	-33.4
800	0.356	-71.3	4.197	102.8	0.108	55.7	0.565	-35.4
1000	0.265	-78.9	3.583	93.9	0.123	55.3	0.518	-36.8
1200	0.194	-85.6	3.135	86.7	0.137	55.7	0.486	-37.5
1400	0.136	-90.5	2.778	80.2	0.153	55.8	0.467	-38.8
1600	0.093	-97.7	2.490	74.4	0.169	55.3	0.449	-40.4
1800	0.058	-109.0	2.260	69.6	0.183	54.8	0.433	-42.6
2000	0.028	-134.7	2.089	65.2	0.199	55.2	0.418	-43.9

**$V_{CE} = 6 V, I_C = 7 mA$**

Frequency (MHz)	S11		S21		S12		S22	
	Mag.	Ang.	Mag.	Ang.	Mag.	Ang.	Mag.	Ang.
200	0.630	-39.7	12.332	138.1	0.037	68.5	0.783	-25.6
400	0.392	-64.1	8.847	114.7	0.059	64.3	0.586	-31.8
600	0.248	-78.3	6.514	101.4	0.077	64.1	0.495	-32.0
800	0.161	-87.5	5.094	92.6	0.096	64.7	0.449	-31.2
1000	0.105	-95.3	4.213	85.9	0.114	64.9	0.423	-30.5
1200	0.060	-106.3	3.589	80.3	0.133	65.0	0.412	-30.8
1400	0.028	-121.7	3.139	74.9	0.154	64.0	0.406	-32.1
1600	0.021	-158.4	2.786	70.1	0.173	62.5	0.398	-34.0
1800	0.035	171.6	2.498	66.0	0.190	61.2	0.387	-36.7
2000	0.054	144.0	2.300	62.3	0.210	60.7	0.377	-38.4

S11e  
 VCE=6V  
 IC=3mA  
 Ta=25°C  
 (UNIT : Ω)

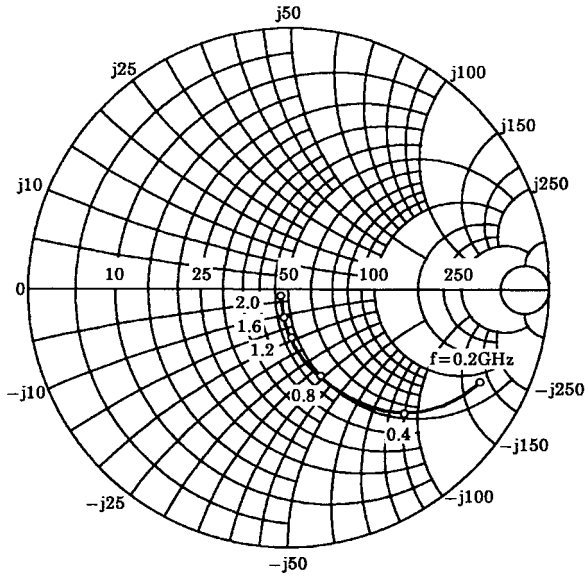

S21e  
 VCE=6V  
 IC=3mA  
 Ta=25°C

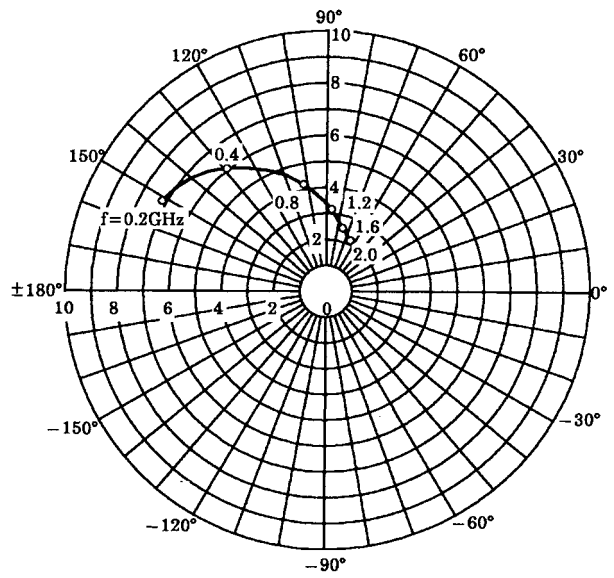

S12e  
 VCE=6V  
 IC=3mA  
 Ta=25°C

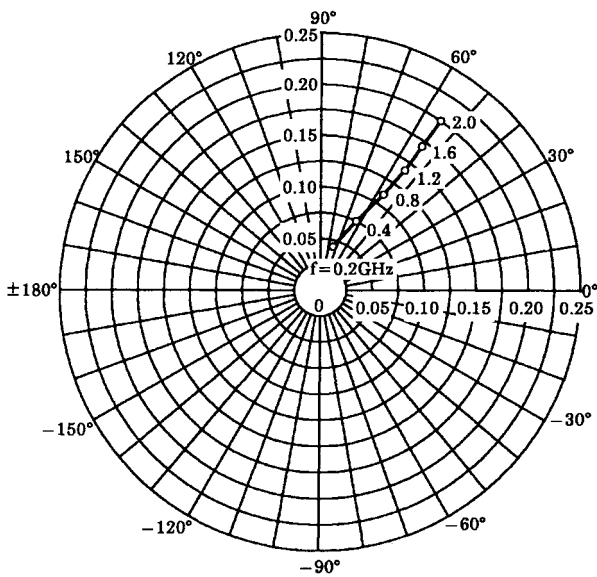

S22e  
 VCE=6V  
 IC=3mA  
 Ta=25°C  
 (UNIT : Ω)

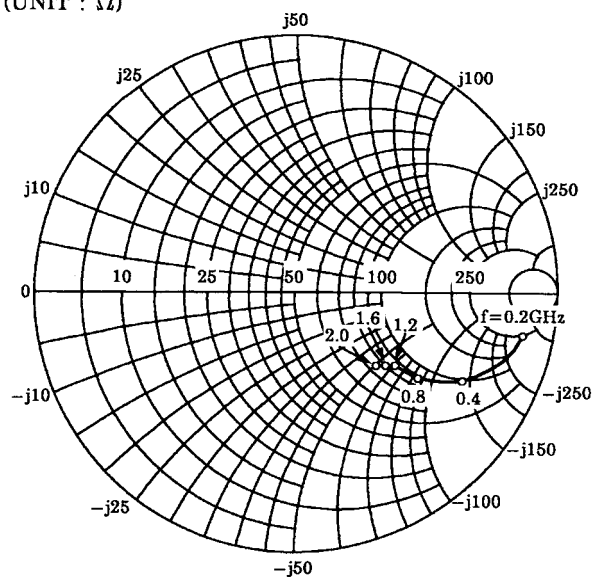

S11e  
 VCE = 6V  
 IC = 7mA  
 Ta = 25°C  
 (UNIT : Ω)

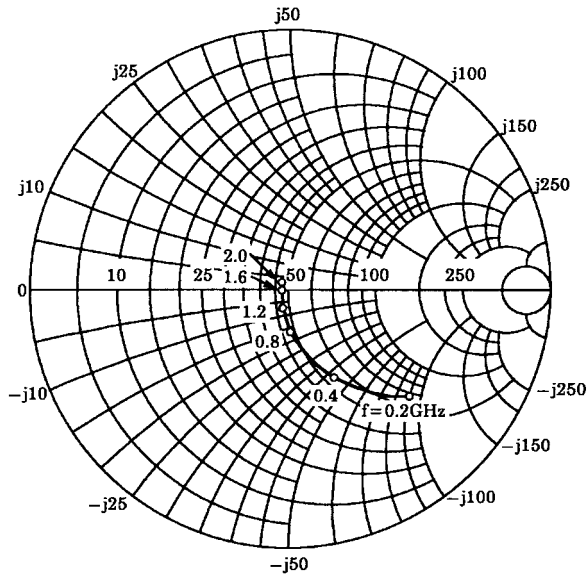

S21e  
 VCE = 6V  
 IC = 7mA  
 Ta = 25°C

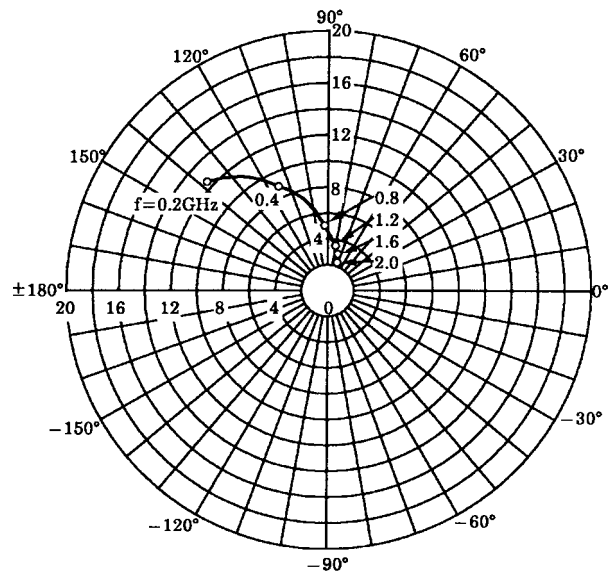

S12e  
 VCE = 6V  
 IC = 7mA  
 Ta = 25°C

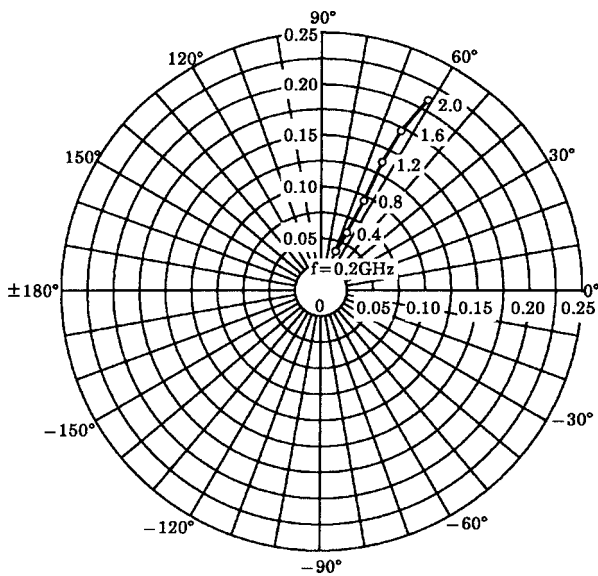

S22e  
 VCE = 6V  
 IC = 7mA  
 Ta = 25°C  
 (UNIT : Ω)

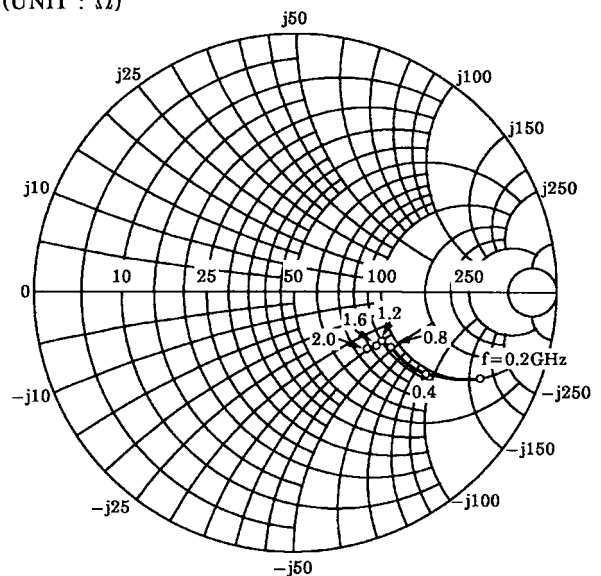

**RESTRICTIONS ON PRODUCT USE**

000707EAA

- TOSHIBA is continually working to improve the quality and reliability of its products. Nevertheless, semiconductor devices in general can malfunction or fail due to their inherent electrical sensitivity and vulnerability to physical stress. It is the responsibility of the buyer, when utilizing TOSHIBA products, to comply with the standards of safety in making a safe design for the entire system, and to avoid situations in which a malfunction or failure of such TOSHIBA products could cause loss of human life, bodily injury or damage to property.  
In developing your designs, please ensure that TOSHIBA products are used within specified operating ranges as set forth in the most recent TOSHIBA products specifications. Also, please keep in mind the precautions and conditions set forth in the "Handling Guide for Semiconductor Devices," or "TOSHIBA Semiconductor Reliability Handbook" etc..
- The TOSHIBA products listed in this document are intended for usage in general electronics applications (computer, personal equipment, office equipment, measuring equipment, industrial robotics, domestic appliances, etc.). These TOSHIBA products are neither intended nor warranted for usage in equipment that requires extraordinarily high quality and/or reliability or a malfunction or failure of which may cause loss of human life or bodily injury ("Unintended Usage"). Unintended Usage include atomic energy control instruments, airplane or spaceship instruments, transportation instruments, traffic signal instruments, combustion control instruments, medical instruments, all types of safety devices, etc.. Unintended Usage of TOSHIBA products listed in this document shall be made at the customer's own risk.
- The information contained herein is presented only as a guide for the applications of our products. No responsibility is assumed by TOSHIBA CORPORATION for any infringements of intellectual property or other rights of the third parties which may result from its use. No license is granted by implication or otherwise under any intellectual property or other rights of TOSHIBA CORPORATION or others.
- The information contained herein is subject to change without notice.