

SHINDENGEN

Switching Power Transistor

FX Series

2SC5241**5A NPN**

OUTLINE DIMENSIONS

Case : FTO-220

Unit : mm

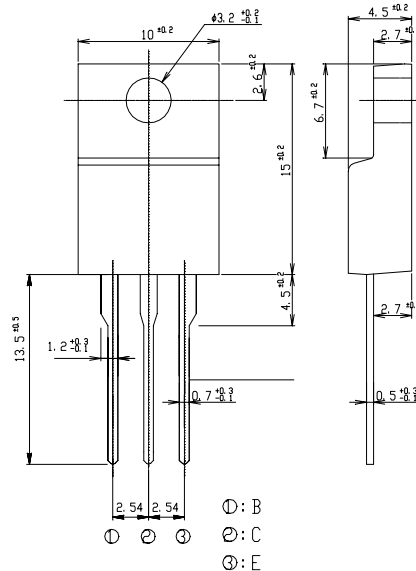

RATINGS

● Absolute Maximum Ratings

Item	Symbol	Conditions	Ratings	Unit
Storage Temperature	T _{stg}		-55~150	°C
Junction Temperature	T _j		150	°C
Collector to Base Voltage	V _{CBO}		600	V
Collector to Emitter Voltage	V _{CEO}		450	V
	V _{CEX}	V _{EB} = 5V	600	V
Emitter to Base Voltage	V _{EBO}		7	V
Collector Current DC	I _C		5	A
Collector Current Peak	I _{CP}		10	A
Base Current DC	I _B		2	A
Base Current Peak	I _{BP}		4	A
Total Transistor Dissipation	P _T		30	W
Dielectric Strength	V _{dis}	Terminals to case, AC 1 minute	2	kV
Mounting Torque	TOR	(Recommended torque)	0.5(0.3)	N·m

● Electrical Characteristics (T_c=25°C)

Item	Symbol	Conditions	Ratings	Unit
Collector to Emitter Sustaining Voltage	V _{CEO(sus)}	I _C = 0.1A	Min 450	V
Collector Cutoff Current	I _{CBO}	rated V _{CBO}	Max 0.1	mA
	I _{CEO}	rated V _{CEO}	Max 0.1	mA
Emitter Cutoff Current	I _{EBO}	rated V _{EBO}	Max 0.1	mA
DC Current Gain	h _{FE}	V _{CE} = 5V, I _C = 2.5A	Min 10	
	h _{FEL}	V _{CE} = 5V, I _C = 1mA	Min 5	
Collector to Emitter Saturation Voltage	V _{CE(sat)}	I _C = 2.5A	Max 1.0	V
Base to Emitter Saturation Voltage	V _{BE(sat)}	I _B = 0.5A	Max 1.5	V
Thermal Resistance	θ _{jc}	Junction to case	Max 4.16	°C/W
Transition Frequency	f _T	V _{CE} = 10V, I _C = 0.5A	STD 20	MHz
Turn on Time	t _{on}	I _C = 2.5A	Max 0.5	μs
Storage Time	t _s	I _{B1} = 0.5A, I _{B2} = 1A	Max 2.0	
Fall Time	t _f	R _L = 60Ω, V _{BB2} = 4V	Max 0.2	

2SC5241

$h_{FE} - I_C$

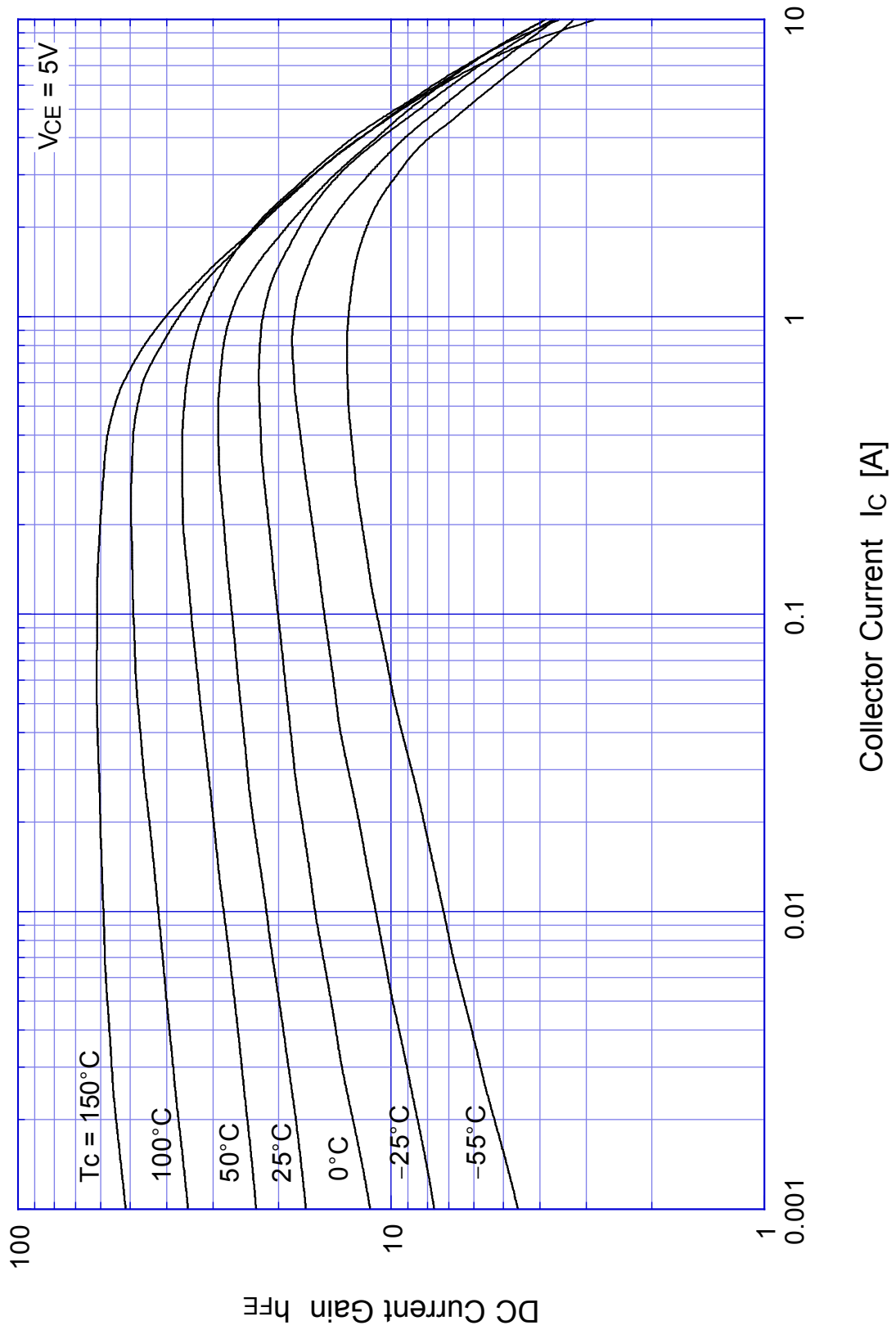

2SC5241 Saturation Voltage

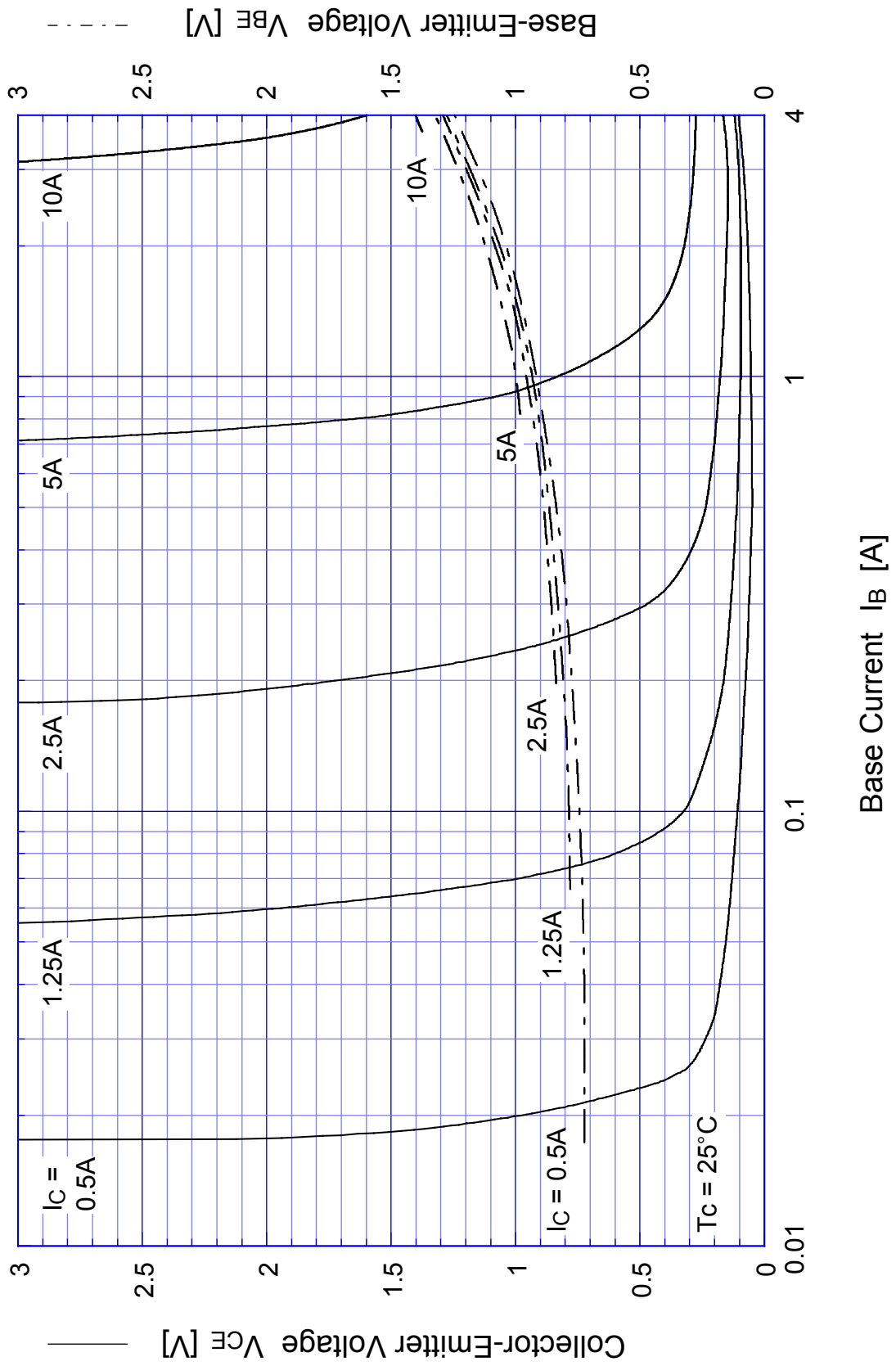

2SC5241 Switching Time - I_C

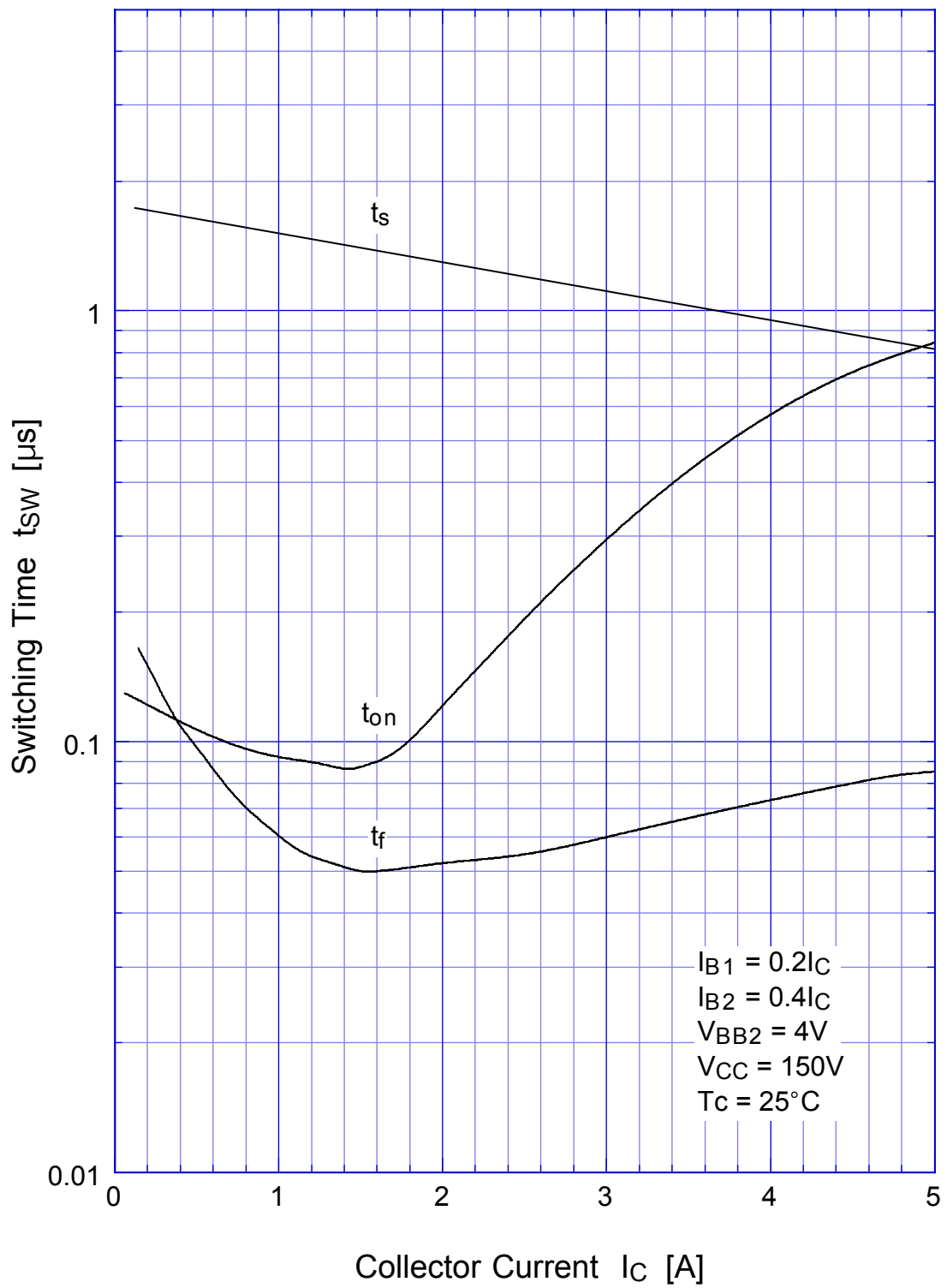

2SC5241 Switching Time - V_{CC}

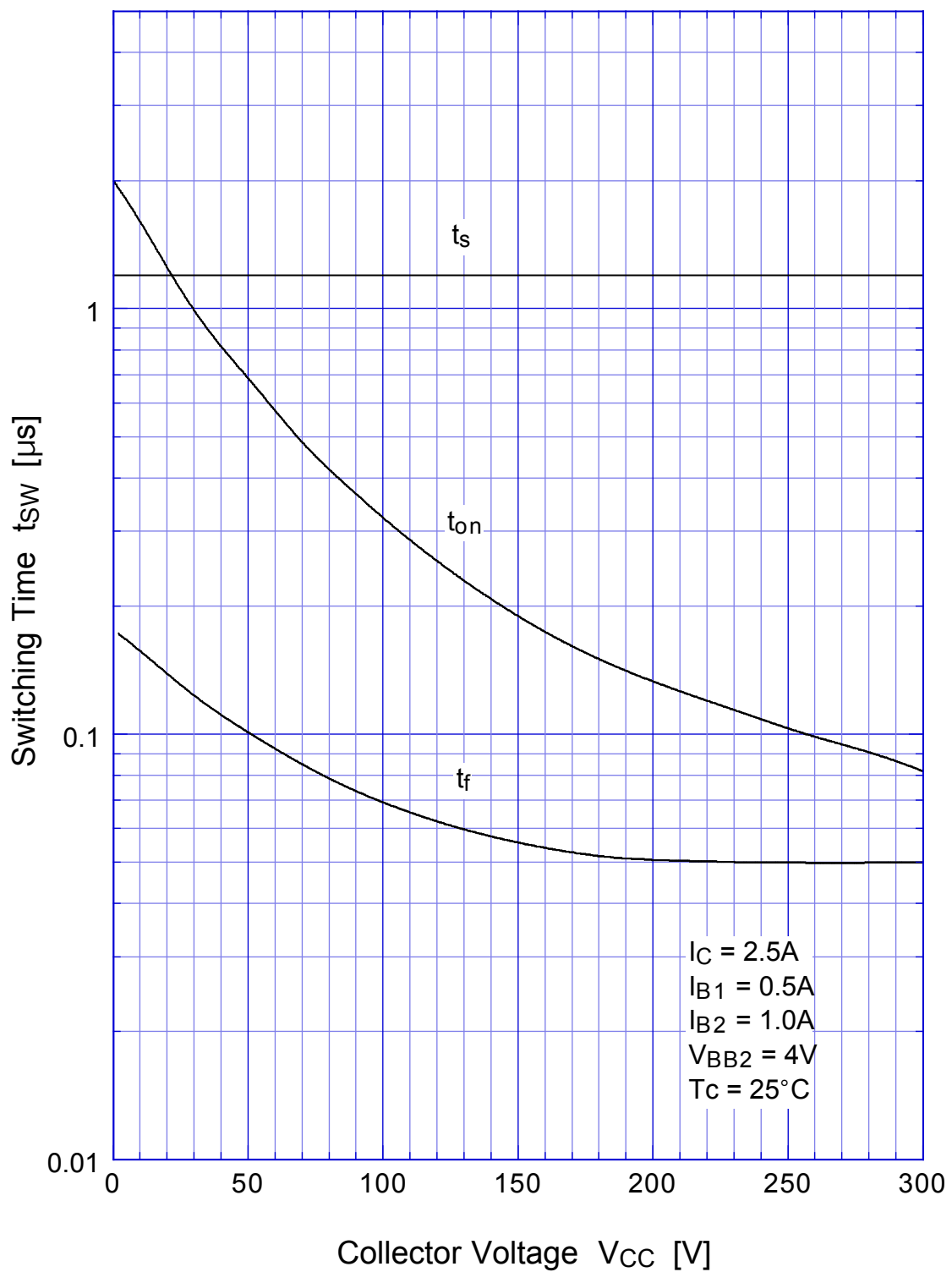

2SC5241 Switching Time - Tc

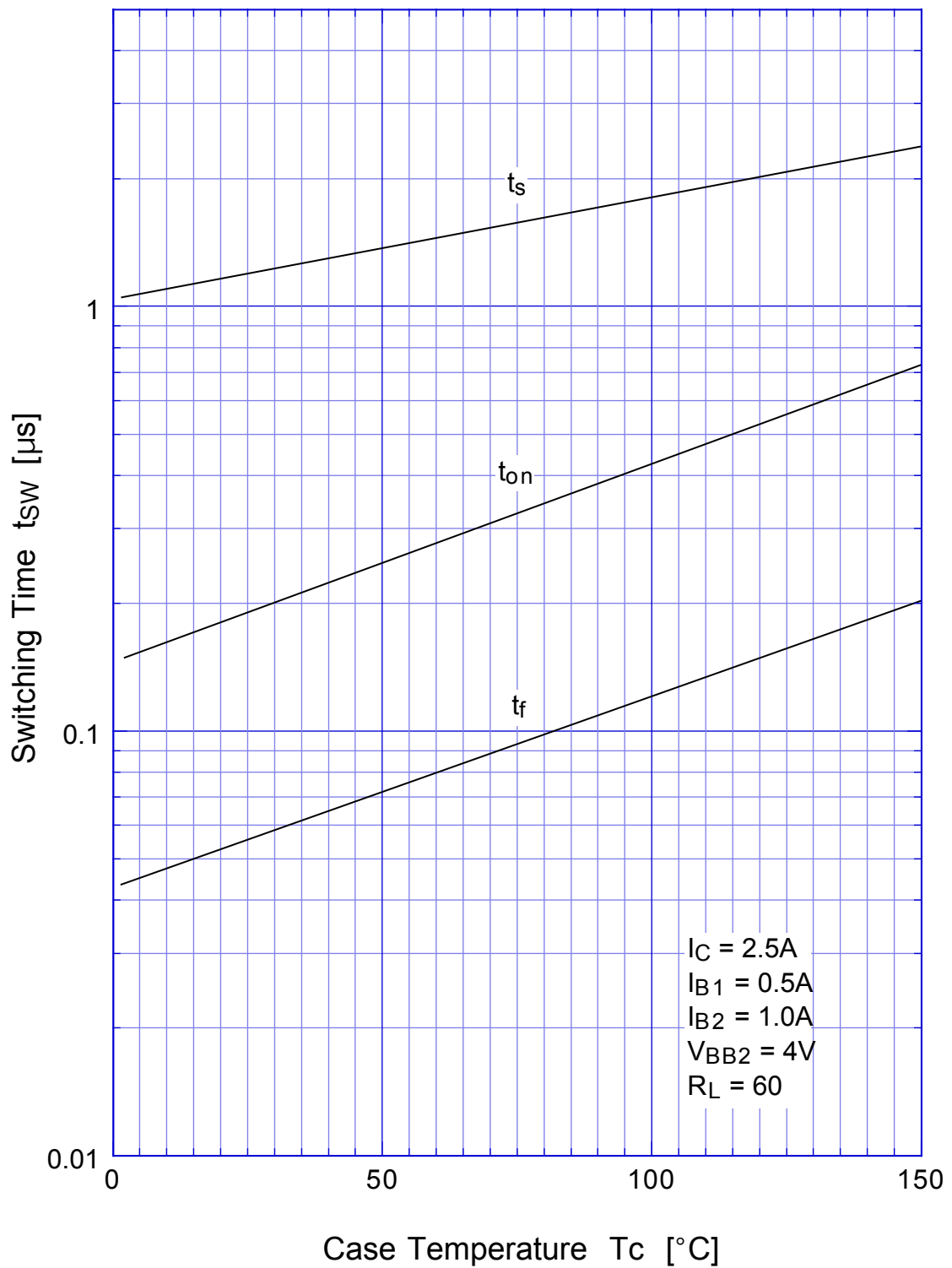

2SC5241 L-Load Switching Time - I_C

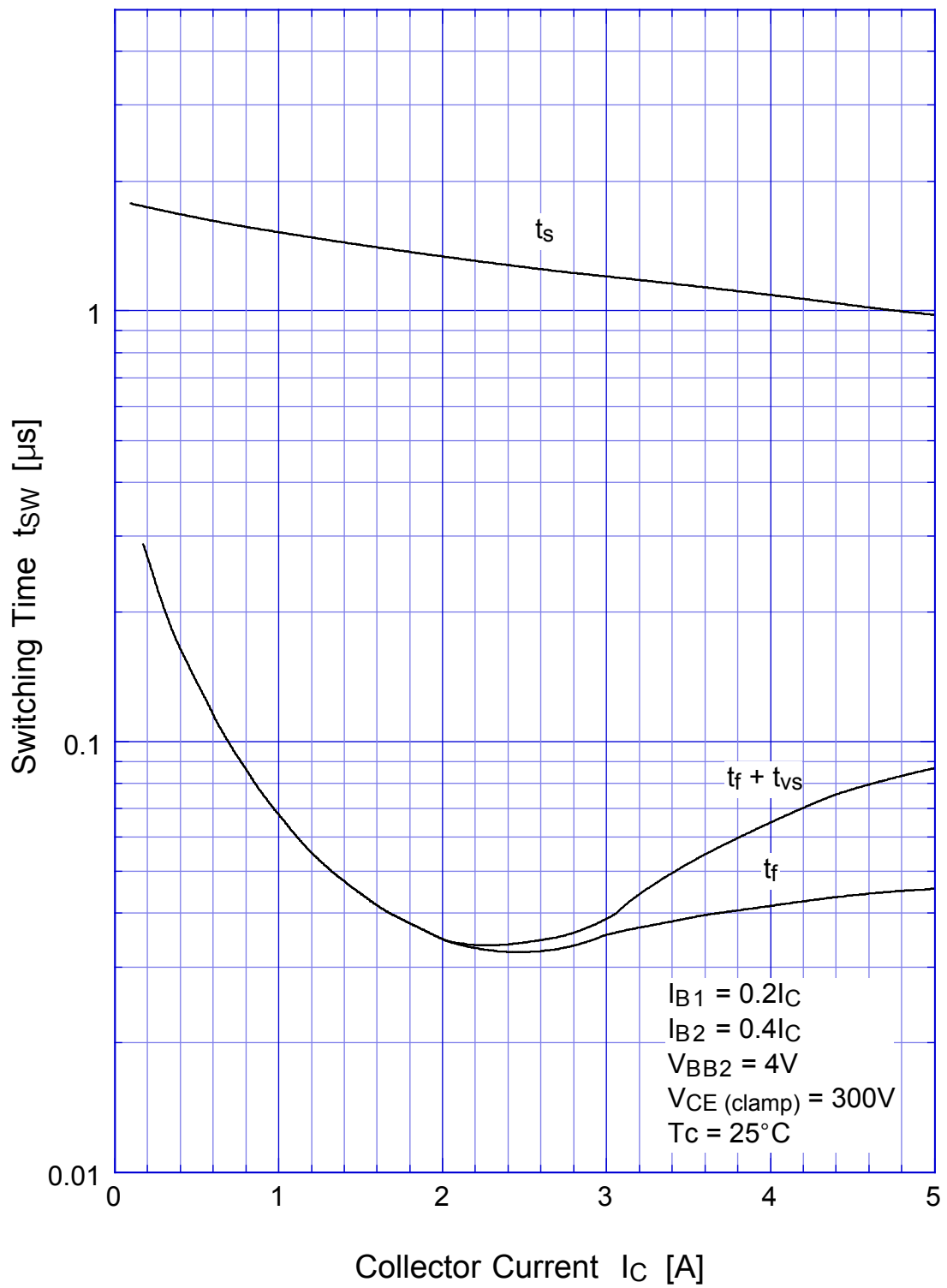

2SC5241 L-Load Switching Time - I_C (At High Temperature)

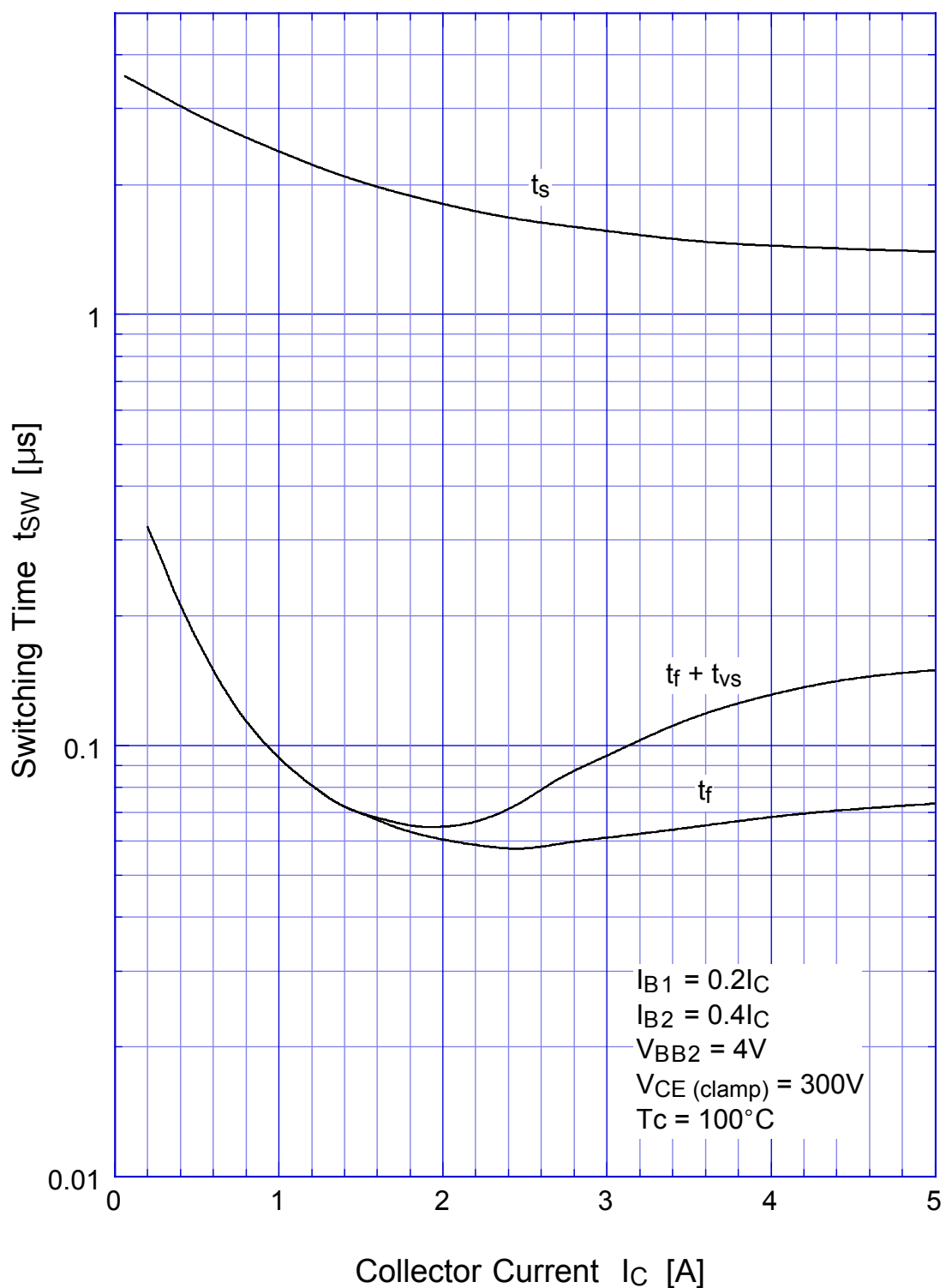

2SC5241 Transient Thermal Impedance

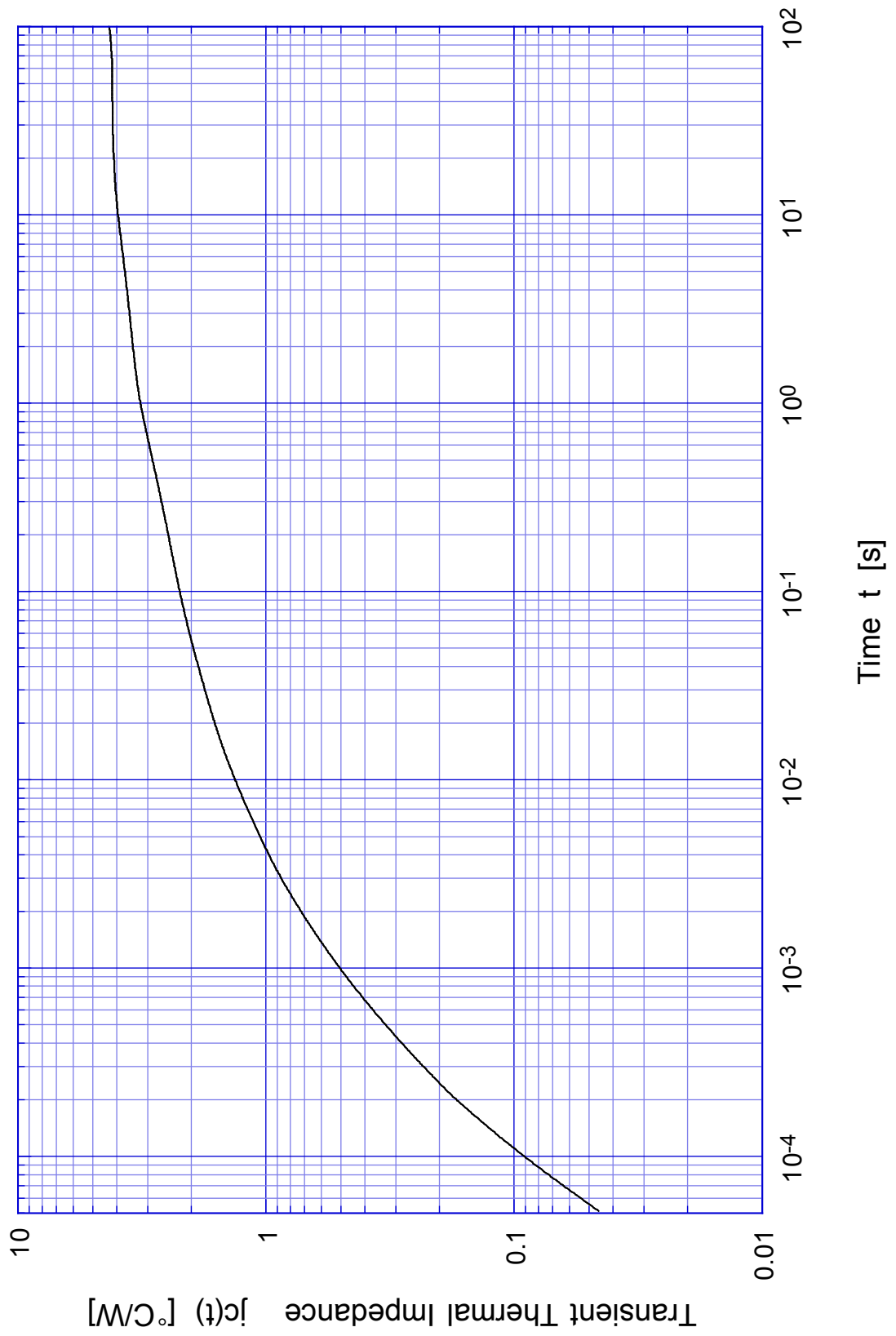

2SC5241 Forward Bias SOA

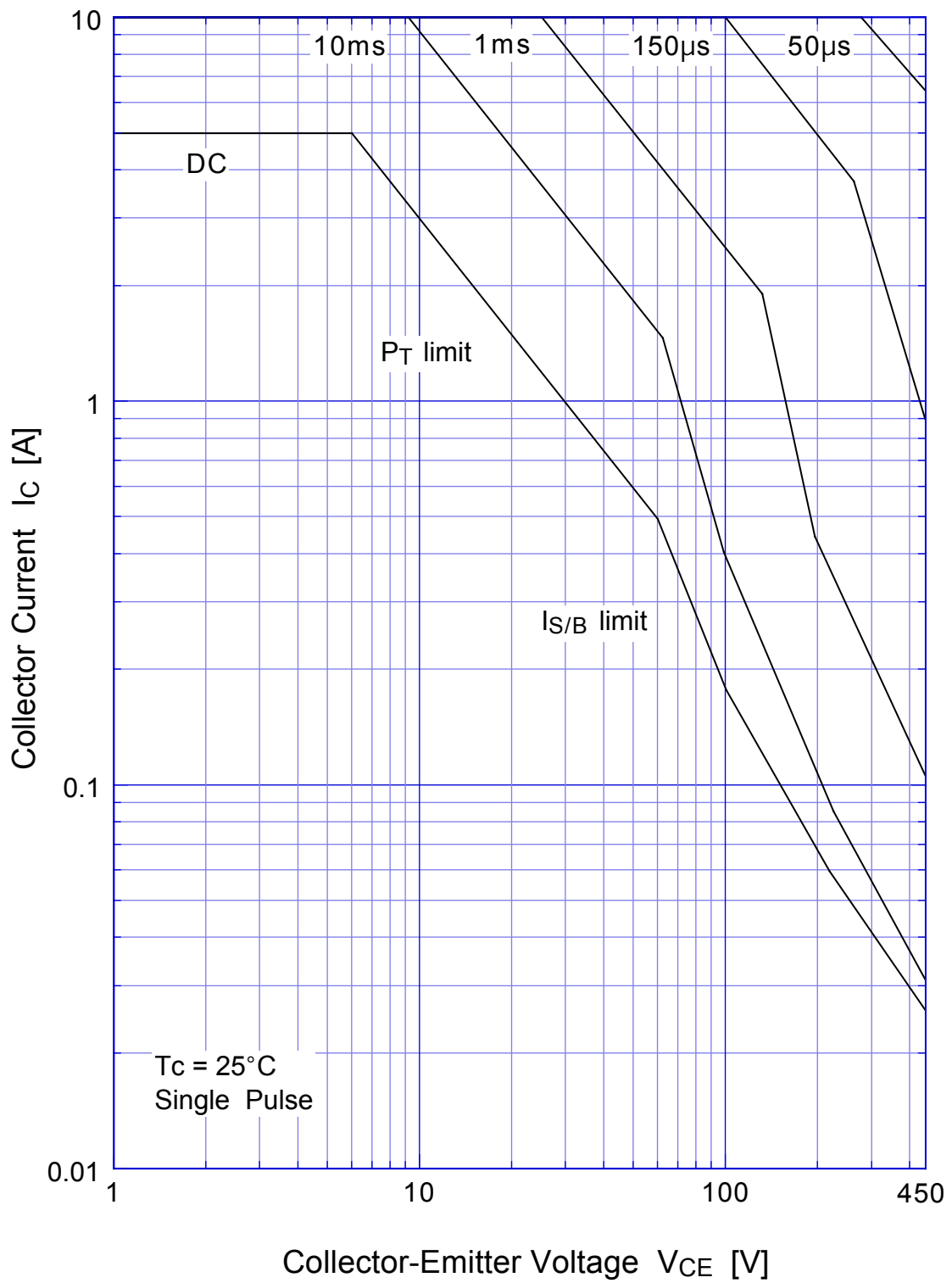

2SC5241 Collector Current Derating

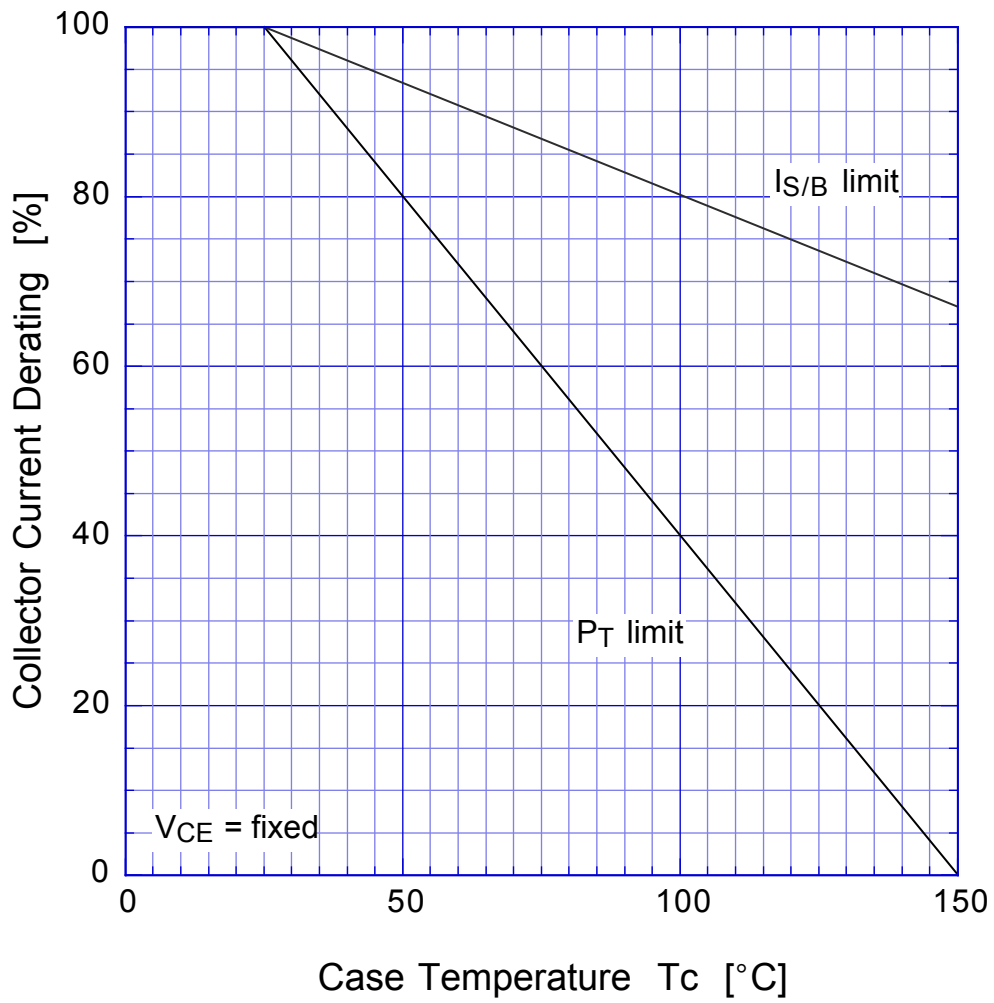

2SC5241 Reverse Bias SOA

