

2SC5383

FOR LOW FREQUENCY AMPLIFY APPLICATION
SILICON NPN EPITAXIAL TYPE(Ultra super mini type)

DESCRIPTION

2SC5383 is a ultra super mini package resin sealed silicon NPN epitaxial transistor, It is designed for low frequency voltage application.

FEATURE

- Small collector to emitter saturation voltage.
VCE(sat)=0.3V max (@Ic=100mA, IB=10mA)
- Excellent linearity of DC forward gain.
- Ultra super mini package for easy mounting

APPLICATION

For Hybrid IC, small type machine low frequency voltage Amplify application.

MAXIMUM RATINGS (Ta=25°C)

Symbol	Parameter	Ratings	Unit
V _{CBO}	Collector to Base voltage	50	V
V _{CEO}	Collector to Emitter voltage	50	V
V _{EBO}	Emitter to Base voltage	6	V
I _O	Collector current	200	mA
P _c	Collector dissipation	150	mW
T _j	Junction temperature	+150	°C
T _{stg}	Storage temperature	-55~+150	°C

OUTLINE DRAWING

Unit: mm

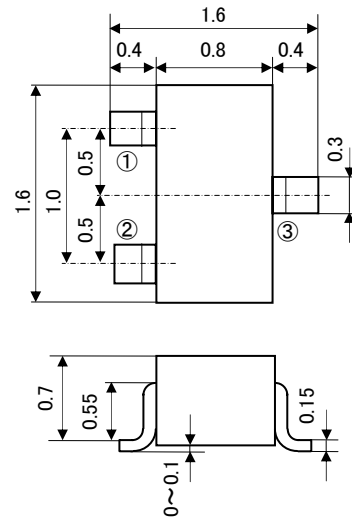

JEITA: SC-75A

JEDEC: -

TERMINAL CONNECTER

- ①: BASE
- ②: EMITTER
- ③: COLLECTOR

ELECTRICAL CHARACTERISTICS (Ta=25°C)

Parameter	Symbol	Test conditions	Limits			Unit
			Min	Typ	Max	
C to E break down voltage	V(BR) _{CEO}	I _C =100μA, R _{BE} =∞	50	-	-	V
Collector cut off current	ICBO	V _{CB} =50V, I _E =0mA	-	-	0.1	μA
Emitter cut off current	IEBO	V _{EB} =6V, I _C =0mA	-	-	0.1	μA
DC forward current gain	hFE	V _{CE} =6V, I _C =1mA	150	-	800	
DC forward current gain	hFE	V _{CE} =6V, I _C =0.1mA	90	-	-	
C to E Saturation Voltage	VCE(sat)	I _C =100mA, I _B =10mA	-	-	0.3	V
Gain bandwidth product	fT	V _{CE} =6V, I _E =-10mA	-	200	-	MHz
Collector output capacitance	Cob	V _{CB} =6V, I _E =0, f=1MHz	-	2.5	-	pF
Noise figure	NF	V _{CE} =6V, I _E =-0.1mA, f=1kHz, RG=2kΩ	-	-	15	dB

※) It shows hFE classification in below table.

Item	E	F	G
hFE Item	150~300	250~500	400~800

FOR LOW FREQUENCY AMPLIFY APPLICATION
SILICON NPN EPITAXIAL TYPE(Ultra super mini type)

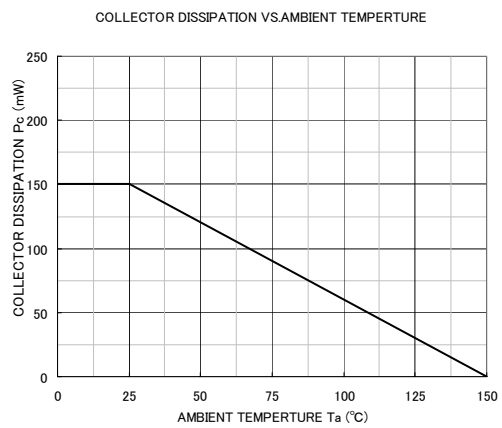
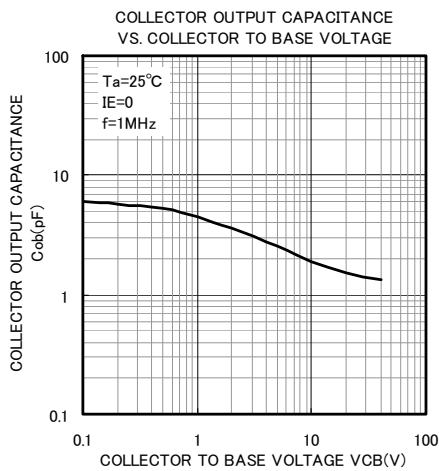
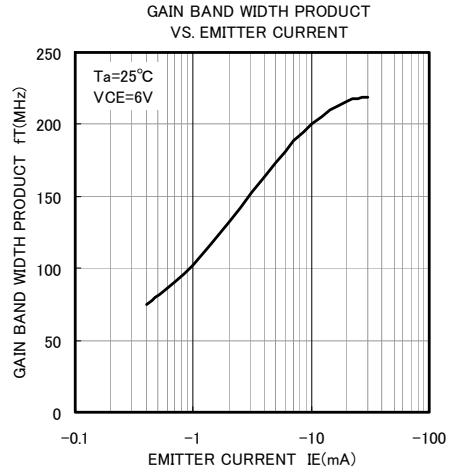
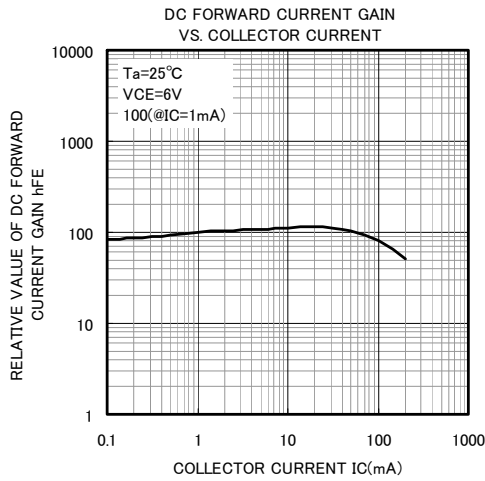
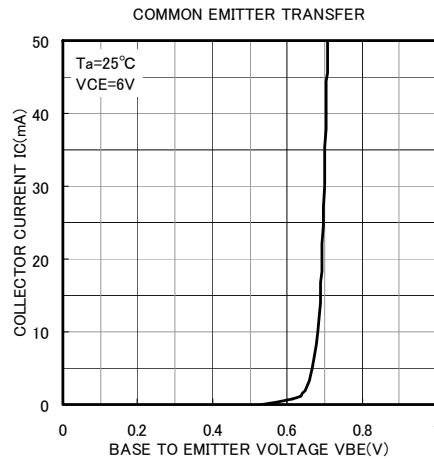
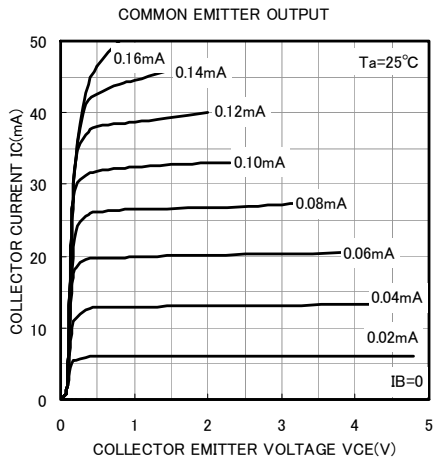

FOR LOW FREQUENCY AMPLIFY APPLICATION
 SILICON NPN EPITAXIAL TYPE(Ultra super mini type)

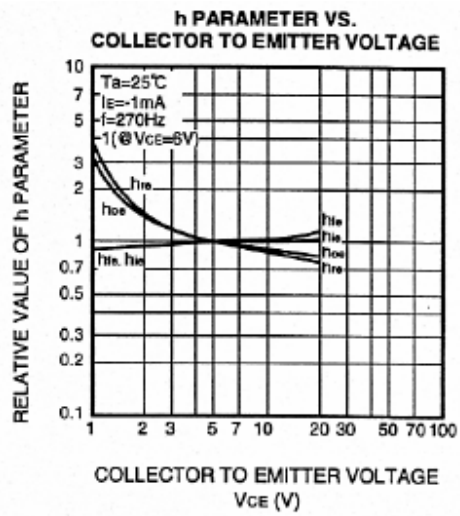
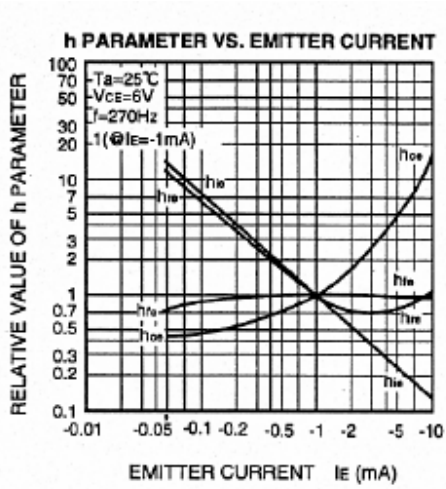

COMMON EMITTER h PARAMETER (TYPICAL VALUE)

Symbol	Parameter	Test conditions	Limits	Unit
h_{ie}	Closed loop small signal input impedance	$T_a=25^\circ\text{C}$ $V_{CE}=6\text{V}$ $I_E=-1\text{mA}$ $f=270\text{Hz}$	8.5	$\text{k}\Omega$
h_{re}	Open loop small signal reverse voltage amplification factor		0.1	$\times 10^{-3}$
h_{fe}	Closed loop small signal forward current amplification factor		300	—
h_{oe}	Open loop small signal output admittance		5.5	μS