

# CAS300M12BM2

## 1.2kV, 4.2 mΩ All-Silicon Carbide Half-Bridge Module

### C2M MOSFET and Z-Rec™ Diode

$V_{DS}$	1.2 kV
$E_{sw, Total @ 300A}$	12 mJ
$R_{DS(on)}$	4.2 mΩ

#### Features

- Ultra Low Loss
- High-Frequency Operation
- Zero Reverse Recovery Current from Diode
- Zero Turn-off Tail Current from MOSFET
- Normally-off, Fail-safe Device Operation
- Ease of Paralleling
- Copper Baseplate and Aluminum Nitride Insulator

#### System Benefits

- Enables Compact and Lightweight Systems
- High Efficiency Operation
- Mitigates Over-voltage Protection
- Reduced Thermal Requirements
- Reduced System Cost

#### Applications

- Induction Heating
- Motor Drives
- Solar and Wind Inverters
- UPS and SMPS
- Traction

**Package 62mm x 106mm x 30mm**



Part Number	Package	Marking
CAS300M12BM2	Half-Bridge Module	CAS300M12BM2

#### Maximum Ratings ( $T_c = 25^\circ\text{C}$ unless otherwise specified)

Symbol	Parameter	Value	Unit	Test Conditions	Notes
$V_{DSmax}$	Drain - Source Voltage	1.2	kV		
$V_{GSmax}$	Gate - Source Voltage	-10/+25	V	Absolute Maximum values	
$V_{GSop}$	Gate - Source Voltage	-5/+20	V	Recommended Operational Values	
$I_D$	Continuous Drain Current	423	A	$V_{GS} = 20\text{ V}, T_c = 25^\circ\text{C}$	Fig. 26
		293		$V_{GS} = 20\text{ V}, T_c = 90^\circ\text{C}$	
$I_{D(pulse)}$	Pulsed Drain Current	1500	A	Pulse width $t_p$ limited by $T_{jmax}$	
$T_{jmax}$	Junction Temperature	150	$^\circ\text{C}$		
$T_c, T_{STG}$	Case and Storage Temperature Range	-40 to +125	$^\circ\text{C}$		
$V_{isol}$	Case Isolation Voltage	5.0	kV	AC, 50 Hz, 1 min	
$L_{Stray}$	Stray Inductance	15	nH	Measured between terminals 2 and 3	
$P_D$	Power Dissipation	1668	W	$T_c = 25^\circ\text{C}, T_j = 150^\circ\text{C}$	Fig. 25



## Electrical Characteristics ( $T_c = 25^\circ\text{C}$ unless otherwise specified)

Symbol	Parameter	Min.	Typ.	Max.	Unit	Test Conditions	Note
$V_{DSS}$	Drain - Source Blocking Voltage	1.2			kV	$V_{GS} = 0\text{ V}, I_D = 2\text{ mA}$	
$V_{GS(th)}$	Gate Threshold Voltage	1.8	2.5		V	$V_{DS} = 10\text{ V}, I_D = 15\text{ mA}$	Fig 7
$I_{DSS}$	Zero Gate Voltage Drain Current		600	2000	$\mu\text{A}$	$V_{DS} = 1.2\text{ kV}, V_{GS} = 0\text{V}$	
			1500			$V_{DS} = 1.2\text{ kV}, V_{GS} = 0\text{V}, T_J = 150^\circ\text{C}$	
$I_{GSS}$	Gate-Source Leakage Current		1	100	nA	$V_{GS} = 20\text{ V}, V_{DS} = 0\text{V}$	
$R_{DS(on)}$	On State Resistance		4.2	5.3	m $\Omega$	$V_{GS} = 20\text{ V}, I_{DS} = 300\text{ A}$	Fig. 4, 5, 6
			7.7			$V_{GS} = 20\text{ V}, I_{DS} = 300\text{ A}, T_J = 150^\circ\text{C}$	
$g_{fs}$	Transconductance		156		S	$V_{DS} = 20\text{ V}, I_{DS} = 300\text{ A}$	Fig. 8
			144			$V_{DS} = 20\text{ V}, I_D = 300\text{ A}, T_J = 150^\circ\text{C}$	
$C_{iss}$	Input Capacitance		19.3		nF	$V_{DS} = 600\text{ V}, f = 200\text{ kHz}, V_{AC} = 25\text{ mV}$	Fig. 16, 17
$C_{oss}$	Output Capacitance		2.57				
$C_{rss}$	Reverse Transfer Capacitance		0.12				
$E_{on}$	Turn-On Switching Energy		5.8		mJ	$V_{DD} = 600\text{ V}, V_{GS} = -5\text{V}/+20\text{V}$ $I_D = 300\text{ A}, R_{G(ext)} = 2.5\ \Omega$ Load = 77 $\mu\text{H}$ , $T_J = 150^\circ\text{C}$ Note: IEC 60747-8-4 Definitions	Fig. 22
$E_{off}$	Turn-Off Switching Energy		6.1		mJ		
$R_{G(int)}$	Internal Gate Resistance		3.0		$\Omega$	$f = 200\text{ kHz}, V_{AC} = 25\text{ mV}$	
$Q_{GS}$	Gate-Source Charge		166		nC	$V_{DD} = 800\text{ V}, V_{GS} = -5\text{V}/+20\text{V}, I_D = 300\text{ A}$ , Per JEDEC24 pg 27	Fig. 15
$Q_{GD}$	Gate-Drain Charge		475				
$Q_G$	Total Gate Charge		1025				
$t_{d(on)}$	Turn-on delay time		76		ns	$V_{DD} = 600\text{V}, V_{GS} = -5/+20\text{V}, I_D = 300\text{ A}, R_{G(ext)} = 2.5\ \Omega$ , Timing relative to $V_{DS}$ Note: IEC 60747-8-4, pg 83 Inductive load	Fig. 23
$t_r$	Rise Time		68		ns		
$t_{d(off)}$	Turn-off delay time		168		ns		
$t_f$	Fall Time		43		ns		
$V_{SD}$	Diode Forward Voltage		1.6	2.0	V	$I_F = 300\text{ A}, V_{GS} = 0$	Fig. 10
			2.0			$I_F = 300\text{ A}, T_J = 150^\circ\text{C}, V_{GS} = 0$	Fig. 11
$Q_C$	Total Capacitive Charge		3.2		$\mu\text{C}$		

Note: The reverse recovery is purely capacitive

## Thermal Characteristics

Symbol	Parameter	Min.	Typ.	Max.	Unit	Test Conditions	Note
$R_{thJCM}$	Thermal Resistance Junction-to-Case for MOSFET		0.070	0.075	$^\circ\text{C}/\text{W}$	$T_c = 90^\circ\text{C}, P_D = 150\text{ W}$	Fig. 27
$R_{thJCD}$	Thermal Resistance Junction-to-Case for Diode		0.073	0.076		$T_c = 90^\circ\text{C}, P_D = 130\text{ W}$	Fig. 28

## Additional Module Data

Symbol	Parameter	Max.	Unit	Test Condition
W	Weight	300	g	
M	Mounting Torque	5	Nm	To heatsink and terminals
	Clearance Distance	9	mm	Terminal to terminal
	Creepage Distance	30	mm	Terminal to terminal
		40	mm	Terminal to baseplate

# Typical Performance

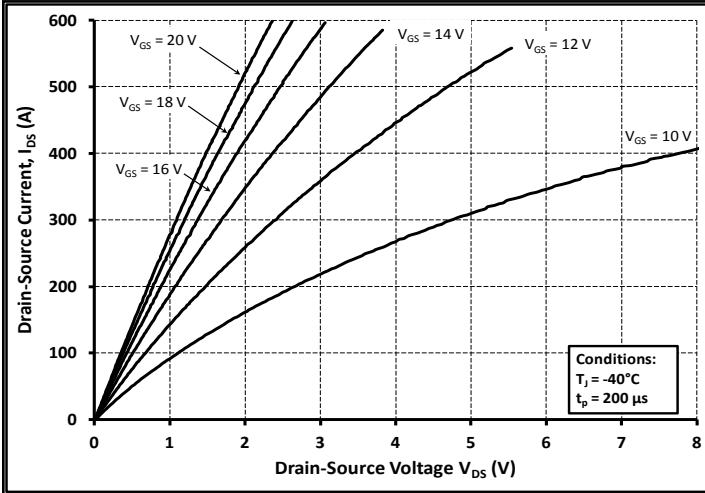

Figure 1. Output Characteristics  $T_J = -40\text{ }^\circ\text{C}$

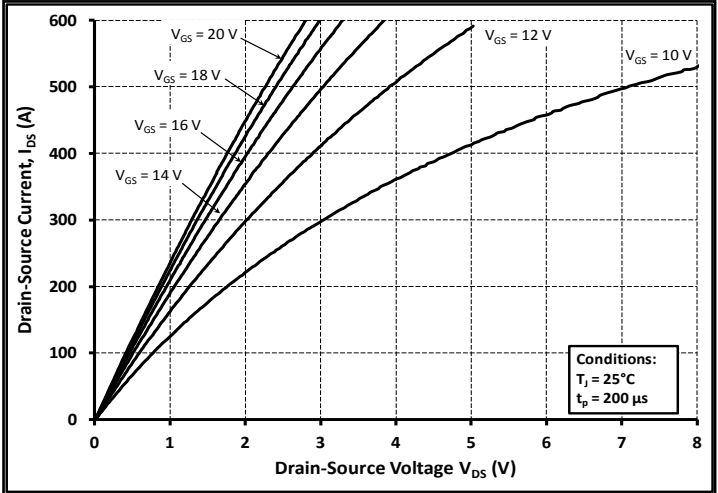

Figure 2. Output Characteristics  $T_J = 25\text{ }^\circ\text{C}$

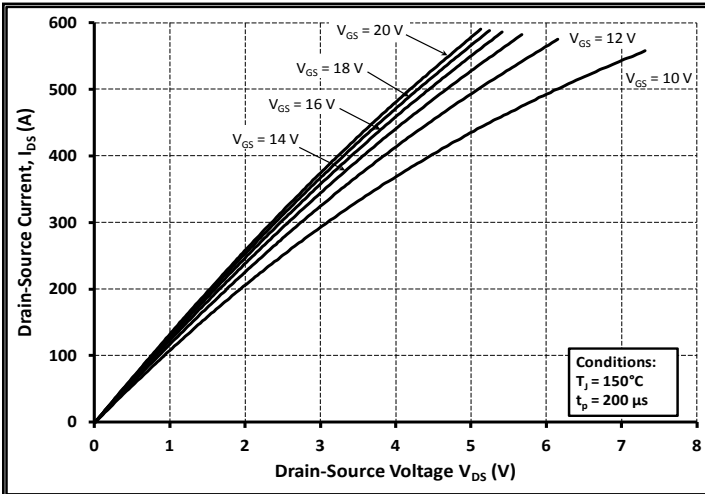

Figure 3. Output Characteristics  $T_J = 150\text{ }^\circ\text{C}$

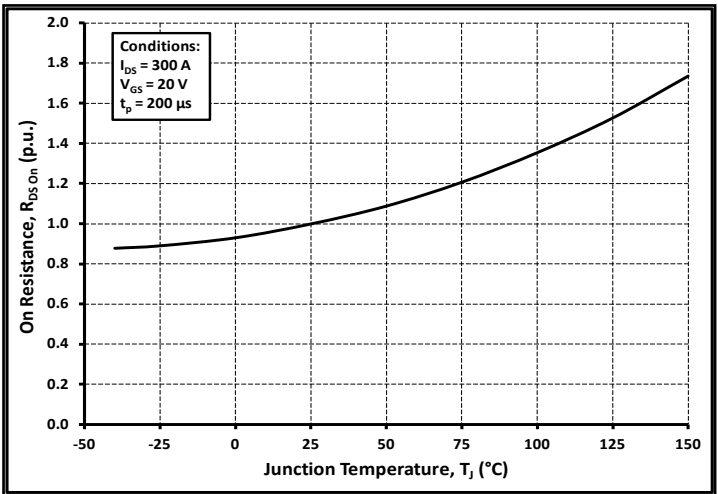

Figure 4. Normalized On-Resistance vs. Temperature

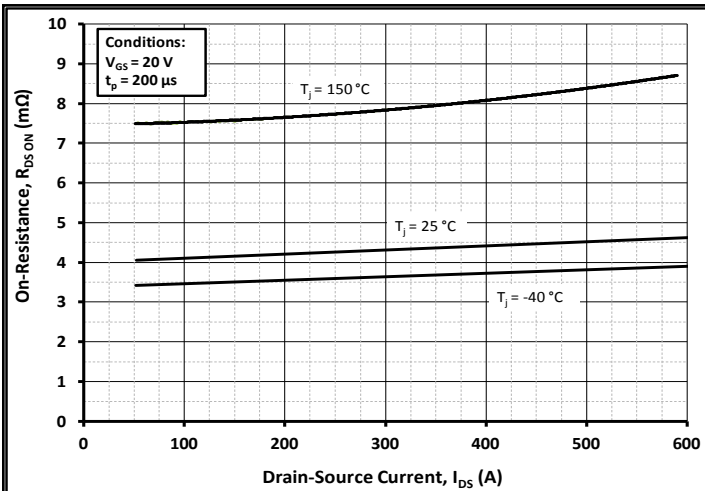

Figure 5. On-Resistance vs. Drain Current for Various Temperatures

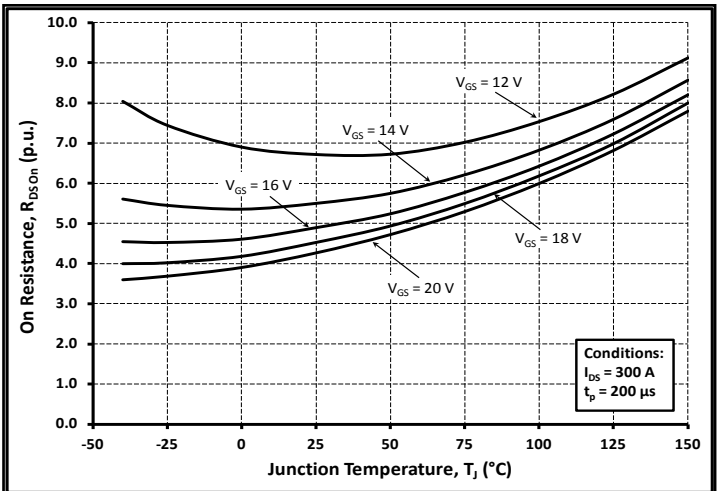

Figure 6. On-Resistance vs. Temperature for Various Gate-Source Voltage

# Typical Performance

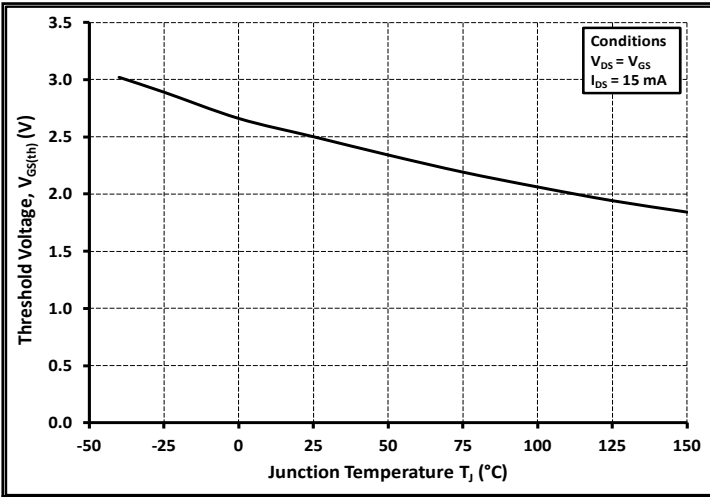

Figure 7. Threshold Voltage vs. Temperature

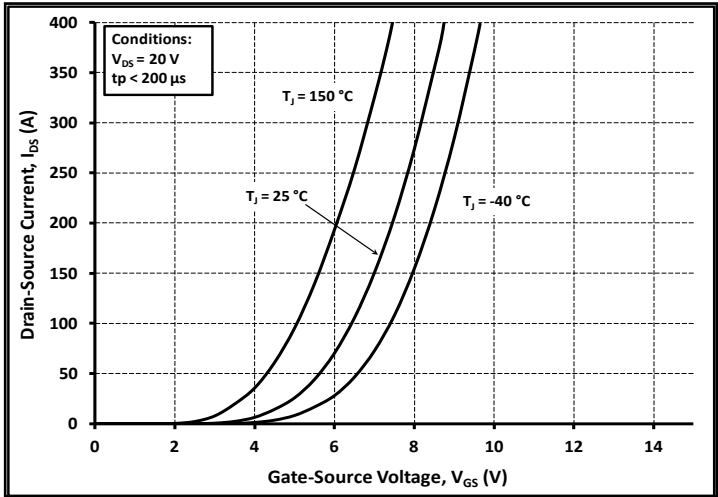

Figure 8. Transfer Characteristic for Various Junction Temperatures

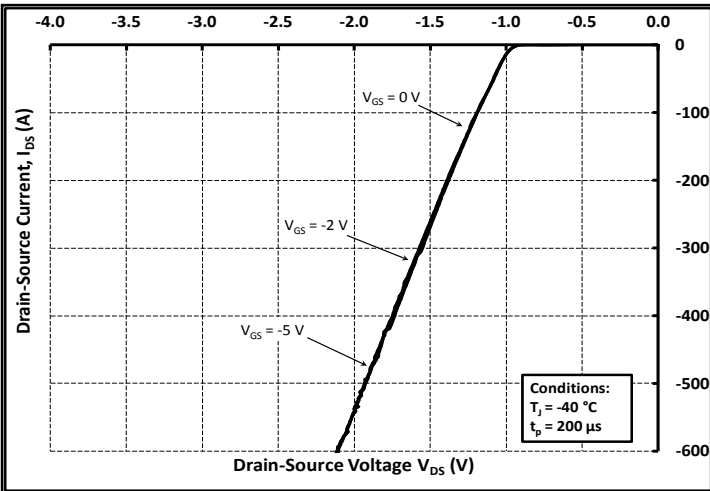

Figure 9. Diode Characteristic at -40 °C

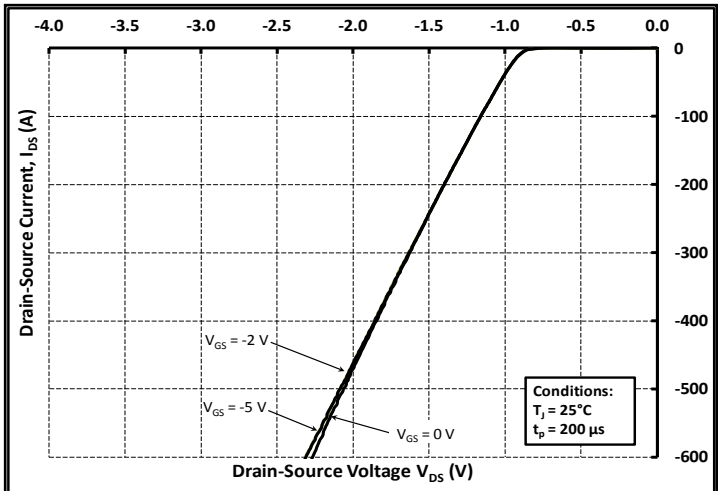

Figure 10. Diode Characteristic at 25 °C

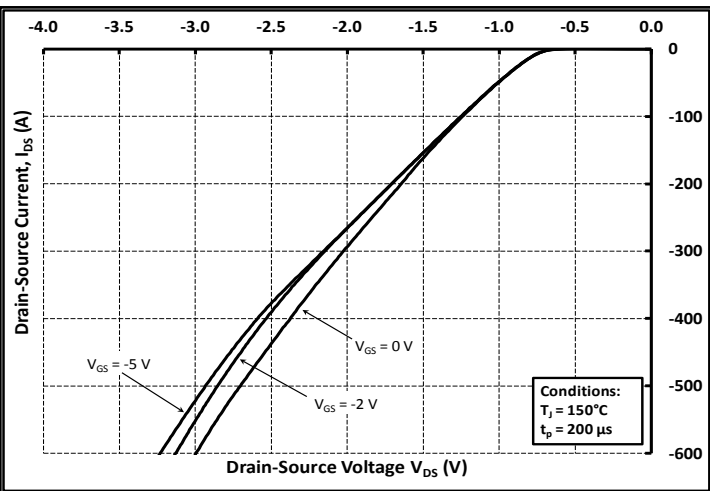

Figure 11. Diode Characteristic at 150 °C

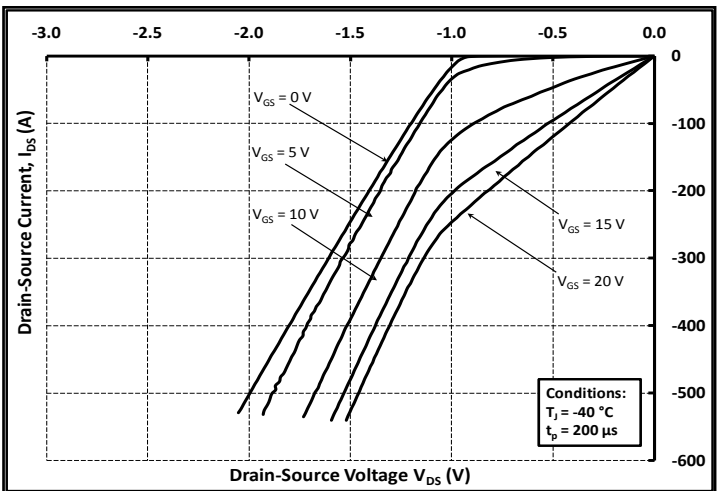

Figure 12. 3<sup>rd</sup> Quadrant Characteristic at -40 °C

# Typical Performance

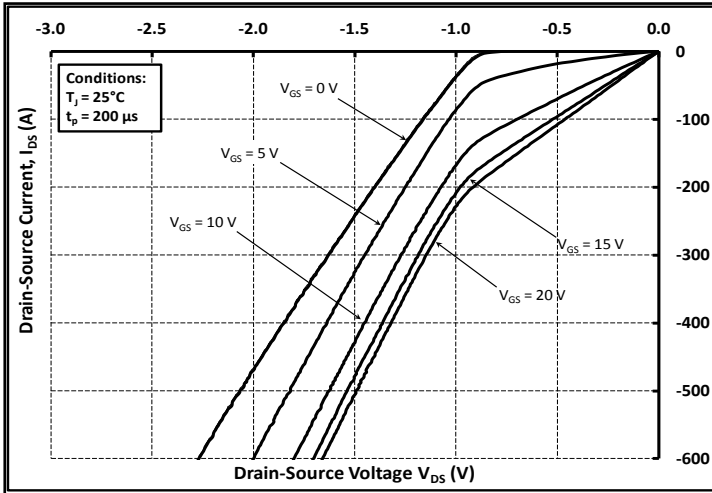

Figure 13. 3<sup>rd</sup> Quadrant Characteristic at 25 °C

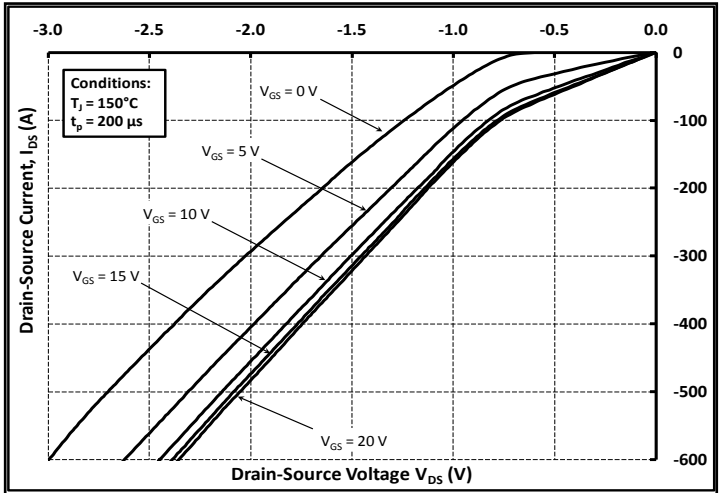

Figure 14. 3<sup>rd</sup> Quadrant Characteristic at 150 °C

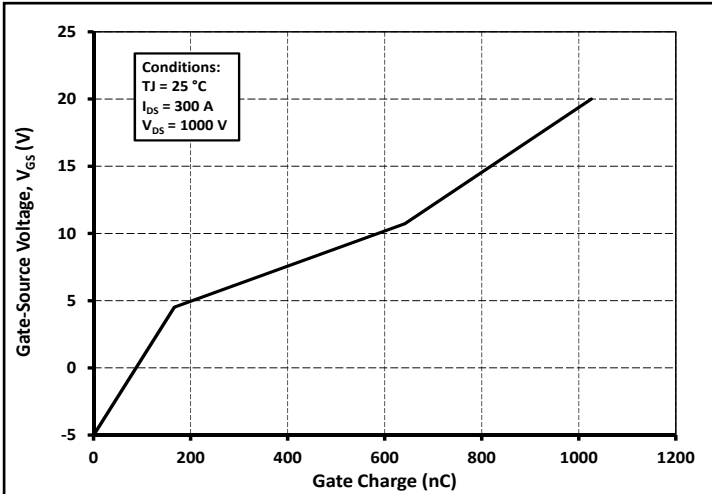

Figure 15. Typical Gate Charge Characteristics

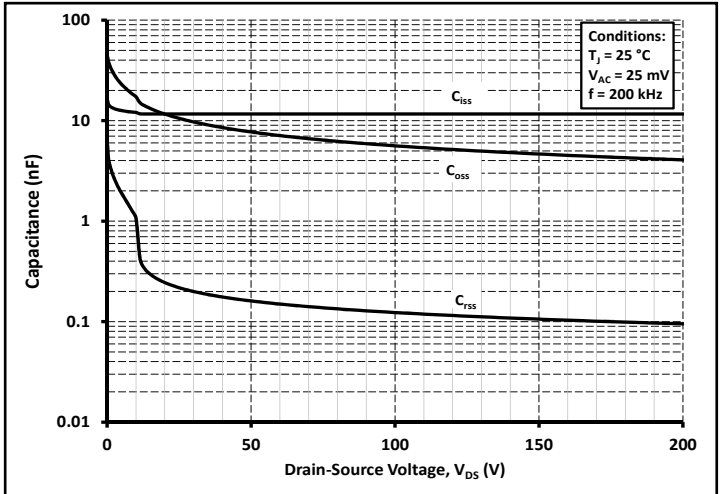

Figure 16. Typical Capacitances vs. Drain-Source Voltage (0 - 200 V)

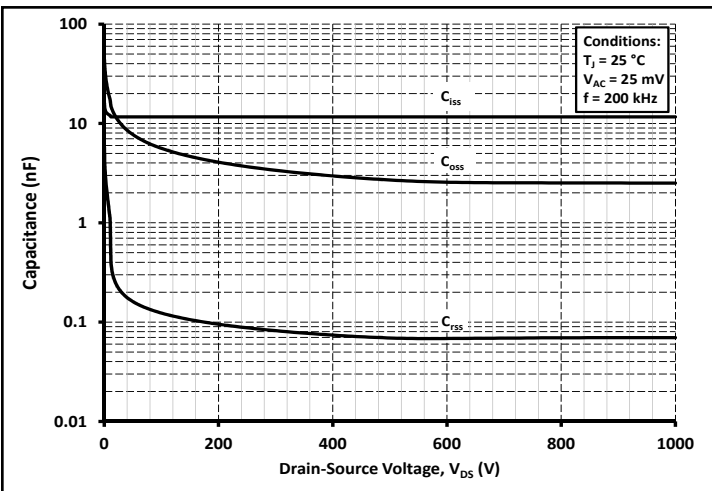

Figure 17. Typical Capacitances vs. Drain-Source Voltage (0 - 1 kV)

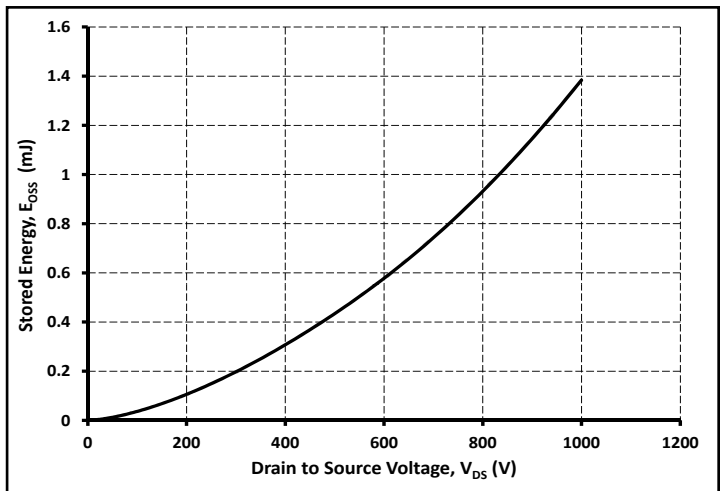

Figure 18. Typical Output Capacitor Stored Energy

## Typical Performance

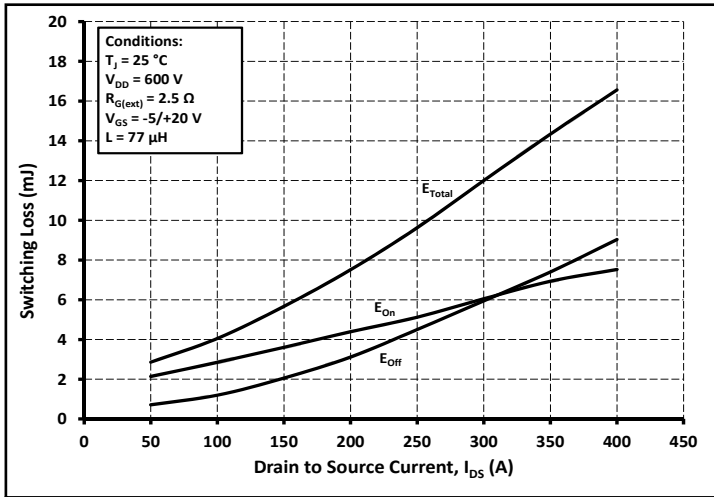

Figure 19. Inductive Switching Energy vs. Drain Current For  $V_{DS} = 600V$ ,  $R_G = 2.5 \Omega$

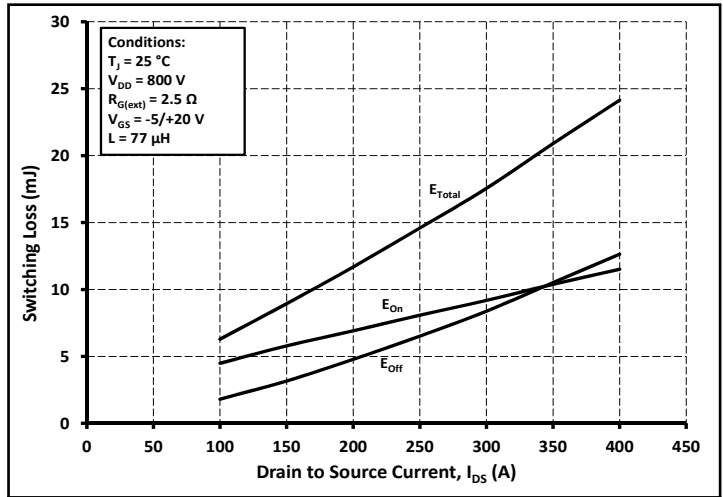

Figure 20. Inductive Switching Energy vs. Drain Current For  $V_{DS} = 800V$ ,  $R_G = 2.5 \Omega$

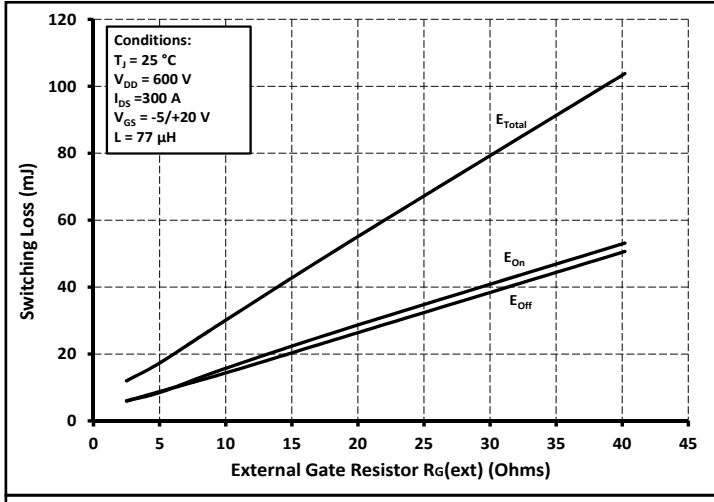

Figure 21. Inductive Switching Energy vs.  $R_{G(ext)}$

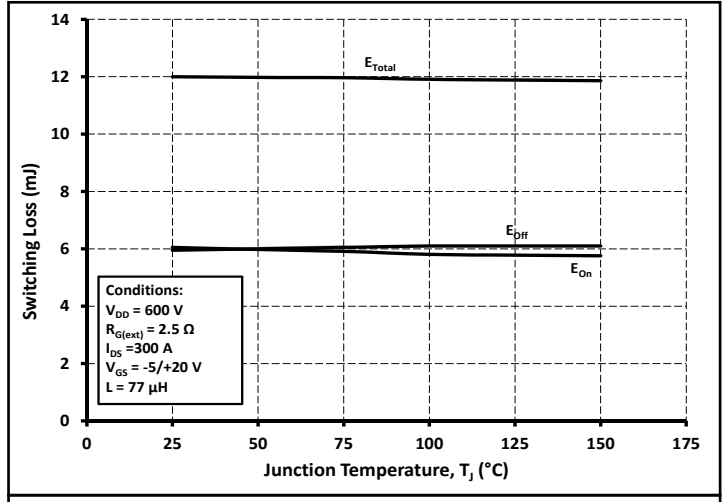

Figure 22. Inductive Switching Energy vs. Temperature

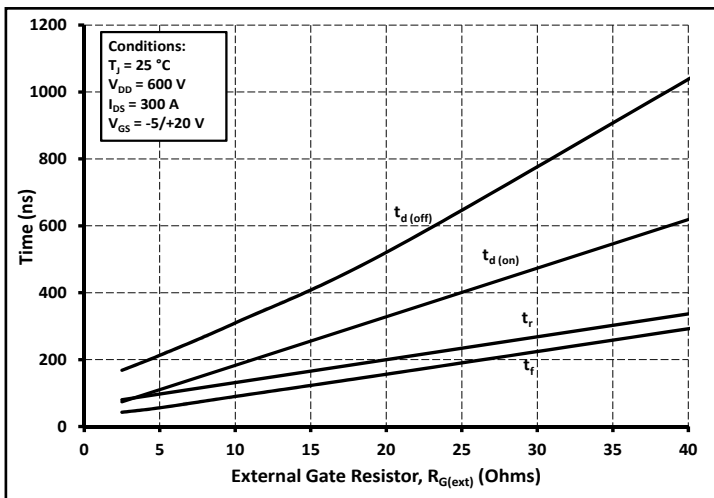

Figure 23. Timing vs  $R_{G(ext)}$

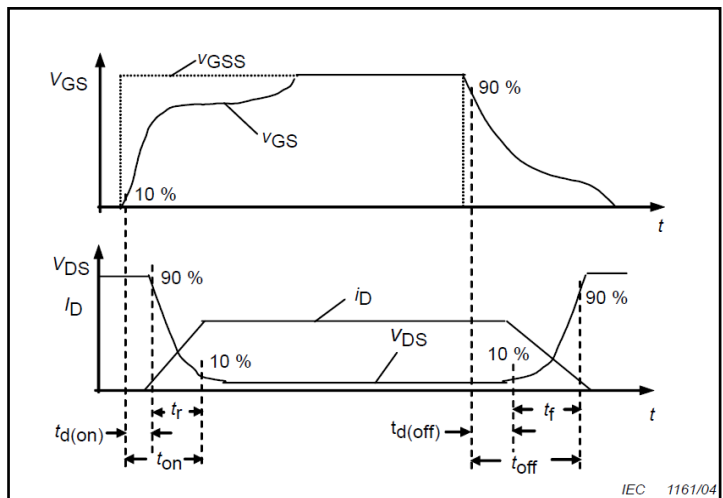

Figure 24. Resistive Switching Time Description

IEC 1161/04

# Typical Performance

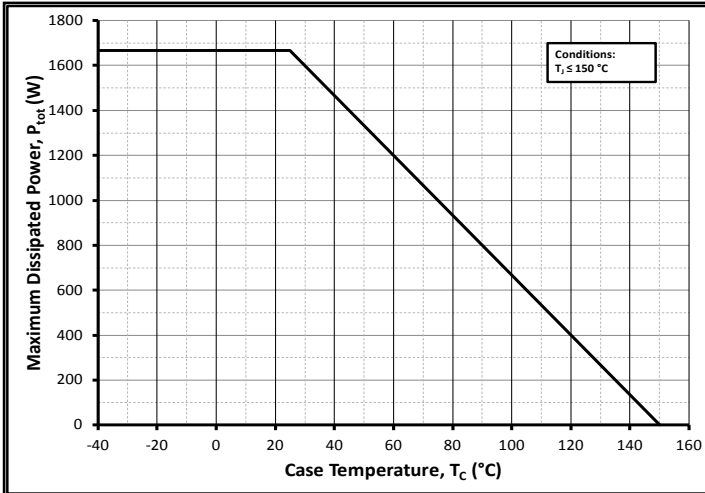

Figure 25. Maximum Power Dissipation (MOSFET) Derating vs Case Temperature

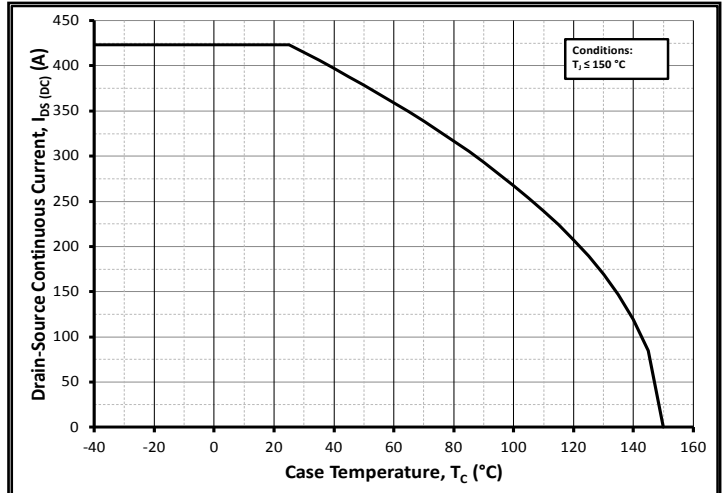

Figure 26. Continuous Drain Current Derating vs Case Temperature

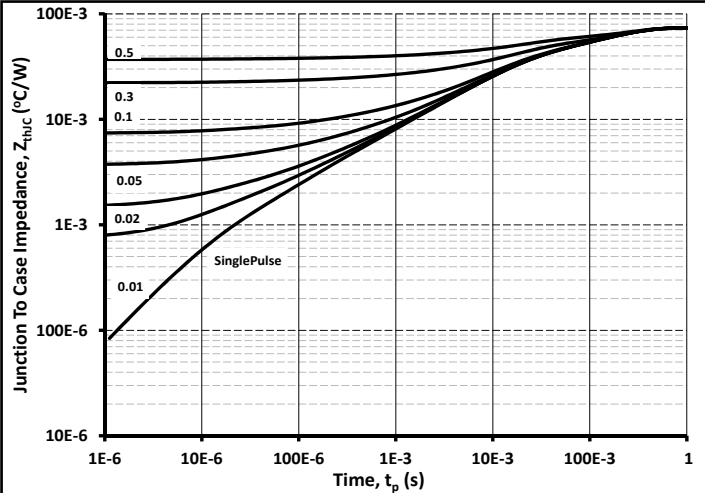

Figure 27. MOSFET Junction to Case Thermal Impedance

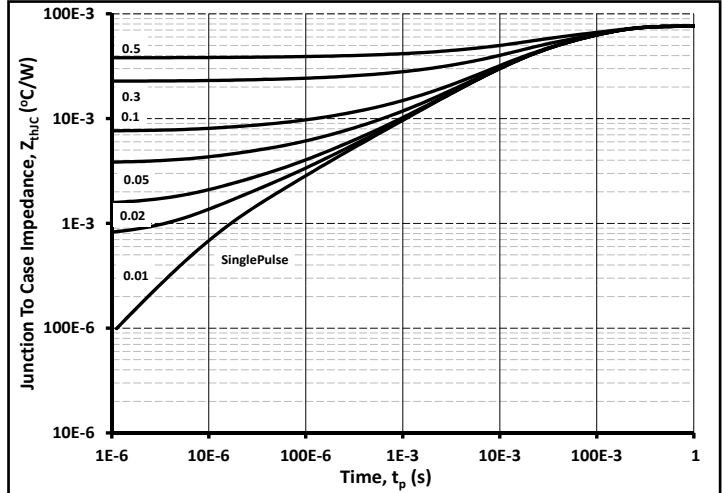

Figure 28. Diode Junction to Case Thermal Impedance

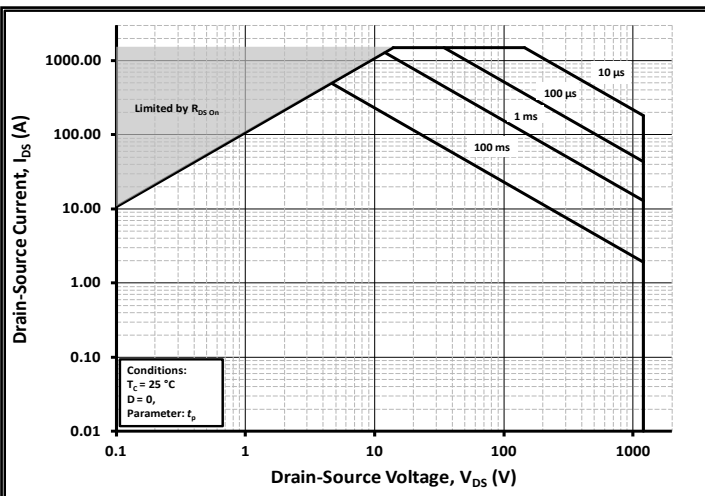
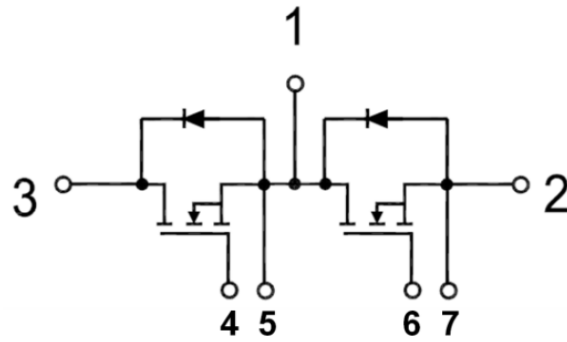
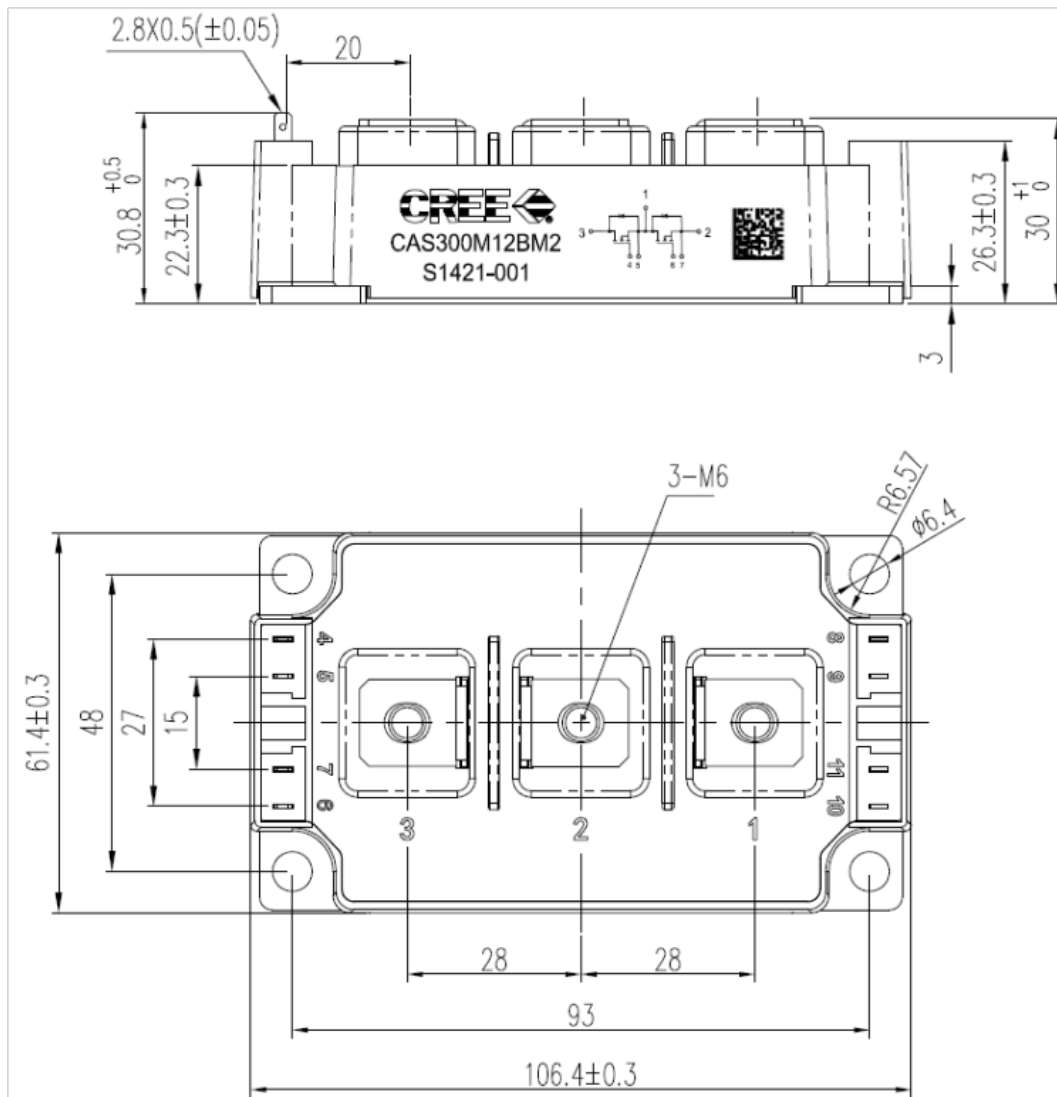

Figure 29. Safe Operating Area

**Schematic**



**Package Dimensions (mm)**







## Notes

---

- **RoHS Compliance**

The levels of RoHS restricted materials in this product are below the maximum concentration values (also referred to as the threshold limits) permitted for such substances, or are used in an exempted application, in accordance with EU Directive 2011/65/EC (RoHS2), as implemented January 2, 2013. RoHS Declarations for this product can be obtained from your Cree representative or from the Product Documentation sections of [www.cree.com](http://www.cree.com).

- **REACH Compliance**

REACH substances of high concern (SVHCs) information is available for this product. Since the European Chemical Agency (ECHA) has published notice of their intent to frequently revise the SVHC listing for the foreseeable future, please contact a Cree representative to insure you get the most up-to-date REACH SVHC Declaration. REACH banned substance information (REACH Article 67) is also available upon request.

- This product has not been designed or tested for use in, and is not intended for use in, applications implanted into the human body nor in applications in which failure of the product could lead to death, personal injury or property damage, including but not limited to equipment used in the operation of nuclear facilities, life-support machines, cardiac defibrillators or similar emergency medical equipment, aircraft navigation or communication or control systems, air traffic control systems.