

# CAT28C16A

## 16 kb CMOS Parallel EEPROM

### Description

The CAT28C16A is a fast, low power, 5V-only CMOS Parallel EEPROM organized as 2K x 8-bits. It requires a simple interface for in-system programming. On-chip address and data latches, self-timed write cycle with auto-clear and  $V_{CC}$  power up/down write protection eliminate additional timing and protection hardware.  $\overline{DATA}$  Polling signals the start and end of the self-timed write cycle. Additionally, the CAT28C16A features hardware write protection.

The CAT28C16A is manufactured using ON Semiconductor's advanced CMOS floating gate technology. It is designed to endure 100,000 program/erase cycles and has a data retention of 100 years. The device is available in JEDEC approved 24-pin DIP and SOIC or 32-pin PLCC packages.

### Features

- Fast Read Access Times: 90 ns, 120 ns, 200 ns
- Low Power CMOS Dissipation:
  - Active: 25 mA Max.
  - Standby: 100  $\mu$ A Max.
- Simple Write Operation:
  - On-chip Address and Data Latches
  - Self-timed Write Cycle with Auto-clear
- Fast Write Cycle Time: 10 ms Max
- End of Write Detection:  $\overline{DATA}$  Polling
- Hardware Write Protection
- CMOS and TTL Compatible I/O
- 100,000 Program/Erase Cycles
- 100 Year Data Retention
- Commercial, Industrial and Automotive Temperature Ranges

### PIN CONFIGURATION

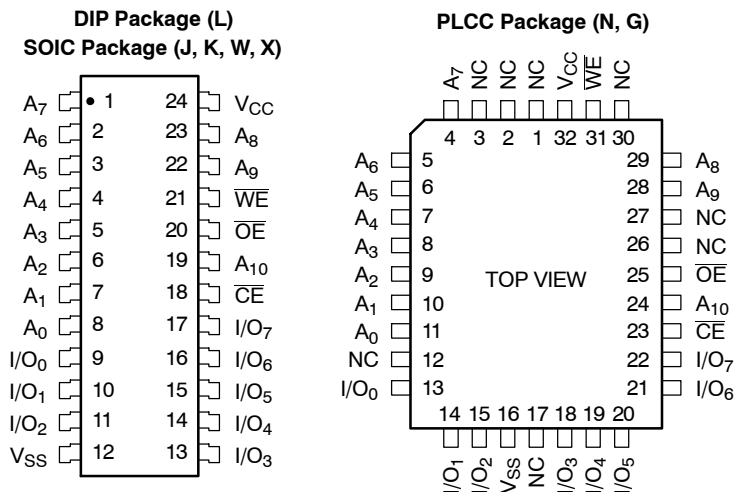

**ON Semiconductor®**

<http://onsemi.com>

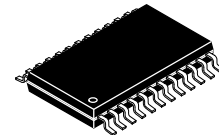

SOIC-24  
J, K, W, X SUFFIX  
CASE 751BK

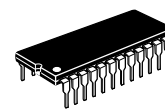

PDIP-24  
L SUFFIX  
CASE 646AD

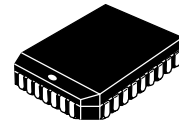

PLCC-32  
N, G SUFFIX  
CASE 776AK

### PIN FUNCTION

Pin Name	Function
$A_0$ - $A_{10}$	Address Inputs
$I/O_0$ - $I/O_7$	Data Inputs/Outputs
$\overline{CE}$	Chip Enable
$\overline{OE}$	Output Enable
$\overline{WE}$	Write Enable
$V_{CC}$	5 V Supply
$V_{SS}$	Ground
NC	No Connect

### ORDERING INFORMATION

See detailed ordering and shipping information in the package dimensions section on page 10 of this data sheet.

# CAT28C16A

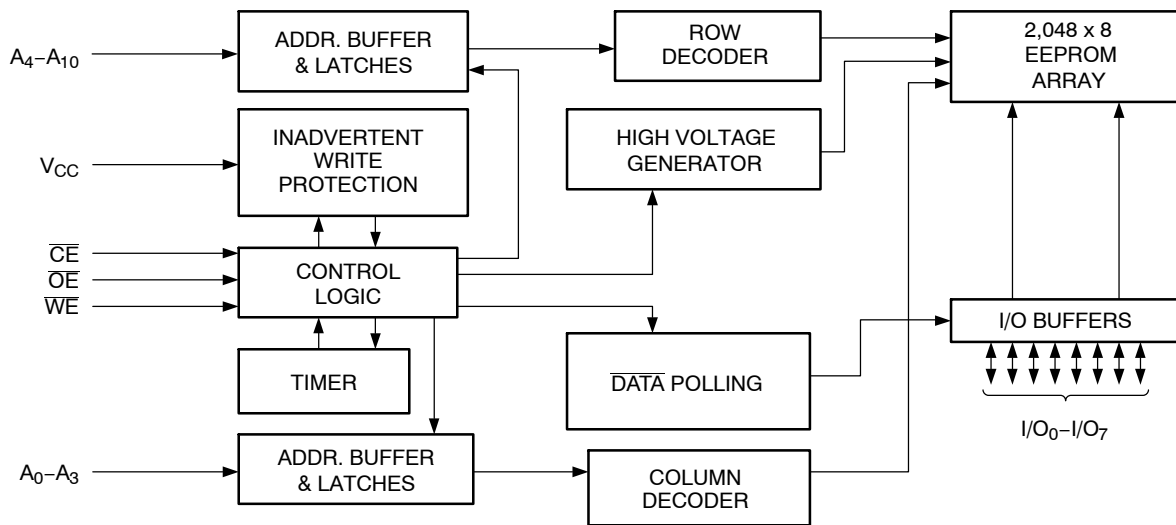

Figure 1. Block Diagram

Table 1. MODE SELECTION

Mode	CE	WE	OE	I/O	Power
Read	L	H	L	D <sub>OUT</sub>	ACTIVE
Byte Write (WE Controlled)	L		H	D <sub>IN</sub>	ACTIVE
Byte Write (CE Controlled)		L	H	D <sub>IN</sub>	ACTIVE
Standby, and Write Inhibit	H	X	X	High-Z	STANDBY
Read and Write Inhibit	X	H	H	High-Z	ACTIVE

Table 2. CAPACITANCE (T<sub>A</sub> = 25°C, f = 1.0 MHz, V<sub>CC</sub> = 5 V)

Symbol	Test	Max	Conditions	Units
C <sub>I/O</sub> (Note 1)	Input/Output Capacitance	10	V <sub>I/O</sub> = 0 V	pF
C <sub>IN</sub> (Note 1)	Input Capacitance	6	V <sub>IN</sub> = 0 V	pF

1. This parameter is tested initially and after a design or process change that affects the parameter.

Table 3. ABSOLUTE MAXIMUM RATINGS

Parameters	Ratings	Units
Temperature Under Bias	-55 to +125	°C
Storage Temperature	-65 to +150	°C
Voltage on Any Pin with Respect to Ground (Note 2)	-2.0 V to +V <sub>CC</sub> + 2.0 V	V
V <sub>CC</sub> with Respect to Ground	-2.0 to +7.0	V
Package Power Dissipation Capability (T <sub>A</sub> = 25°C)	1.0	W
Lead Soldering Temperature (10 secs)	300	°C
Output Short Circuit Current (Note 3)	100	mA

Stresses exceeding Maximum Ratings may damage the device. Maximum Ratings are stress ratings only. Functional operation above the Recommended Operating Conditions is not implied. Extended exposure to stresses above the Recommended Operating Conditions may affect device reliability.

2. The minimum DC input voltage is -0.5 V. During transitions, inputs may undershoot to -2.0 V for periods of less than 20 ns. Maximum DC voltage on output pins is V<sub>CC</sub> + 0.5 V, which may overshoot to V<sub>CC</sub> + 2.0 V for periods of less than 20 ns.

3. Output shorted for no more than one second. No more than one output shorted at a time.

# CAT28C16A

**Table 4. RELIABILITY CHARACTERISTICS** (Note 4)

Symbol	Parameter	Min	Max	Units
$N_{END}$ (Note 5)	Endurance	100,000		Cycles/Byte
$T_{DR}$ (Notes 5)	Data Retention	100		Years
$V_{ZAP}$	ESD Susceptibility	2,000		V
$I_{LTH}$ (Note 6)	Latch-Up	100		mA

4. This parameter is tested initially and after a design or process change that affects the parameter.  
 5. For the CAT28C16A-20, the minimum endurance is 10,000 cycles and the minimum data retention is 10 years.  
 6. Latch-up protection is provided for stresses up to 100 mA on address and data pins from -1 V to  $V_{CC} + 1$  V.

**Table 5. D.C. OPERATING CHARACTERISTICS** ( $V_{CC} = 5$  V  $\pm 10\%$ , unless otherwise specified.)

Symbol	Parameter	Test Conditions	Limits			Units
			Min	Typ	Max	
$I_{CC}$	$V_{CC}$ Current (Operating, TTL)	$\overline{CE} = \overline{OE} = V_{IL}$ , $f = 1/t_{RC}$ min, All I/O's Open			35	mA
$I_{CCC}$ (Note 7)	$V_{CC}$ Current (Operating, CMOS)	$\overline{CE} = \overline{OE} = V_{ILC}$ , $f = 1/t_{RC}$ min, All I/O's Open			25	mA
$I_{SB}$	$V_{CC}$ Current (Standby, TTL)	$\overline{CE} = V_{IH}$ , All I/O's Open			1	mA
$I_{SBC}$ (Note 8)	$V_{CC}$ Current (Standby, CMOS)	$\overline{CE} = V_{IHC}$ , All I/O's Open			100	$\mu$ A
$I_{LI}$	Input Leakage Current	$V_{IN} = GND$ to $V_{CC}$	-10		10	$\mu$ A
$I_{LO}$	Output Leakage Current	$V_{OUT} = GND$ to $V_{CC}$ , $\overline{CE} = V_{IH}$	-10		10	$\mu$ A
$V_{IH}$ (Note 8)	High Level Input Voltage		2		$V_{CC} + 0.3$	V
$V_{IL}$ (Note 7)	Low Level Input Voltage		-0.3		0.8	V
$V_{OH}$	High Level Output Voltage	$I_{OH} = -400$ $\mu$ A	2.4			V
$V_{OL}$	Low Level Output Voltage	$I_{OL} = 2.1$ mA			0.4	V
$V_{WI}$	Write Inhibit Voltage		3.0			V

7.  $V_{ILC} = -0.3$  V to  $+0.3$  V  
 8.  $V_{IHC} = V_{CC} - 0.3$  V to  $V_{CC} + 0.3$  V

**Table 6. A.C. CHARACTERISTICS, READ CYCLE** ( $V_{CC} = 5$  V  $\pm 10\%$ , unless otherwise specified.)

Symbol	Parameter	28C16A-90		28C16A-12		28C16A-20		Units
		Min	Max	Min	Max	Min	Max	
$t_{RC}$	Read Cycle Time	90		120		200		ns
$t_{CE}$	$\overline{CE}$ Access Time		90		120		200	ns
$t_{AA}$	Address Access Time		90		120		200	ns
$t_{OE}$	$\overline{OE}$ Access Time		50		60		80	ns
$t_{LZ}$ (Note 9)	$\overline{CE}$ Low to Active Output	0		0		0		ns
$t_{OLZ}$ (Note 9)	$\overline{OE}$ Low to Active Output	0		0		0		ns
$t_{HZ}$ (Notes 9, 10)	$\overline{CE}$ High to High-Z Output		50		50		55	ns
$t_{OHZ}$ (Notes 9, 10)	$\overline{OE}$ High to High-Z Output		50		50		55	ns
$t_{OH}$ (Note 9)	Output Hold from Address Change	0		0		0		ns

9. This parameter is tested initially and after a design or process change that affects the parameter.  
 10. Output floating (High-Z) is defined as the state when the external data line is no longer driven by the output buffer.

# CAT28C16A

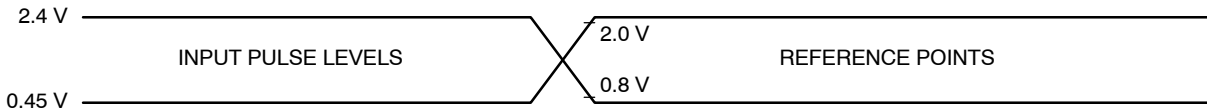
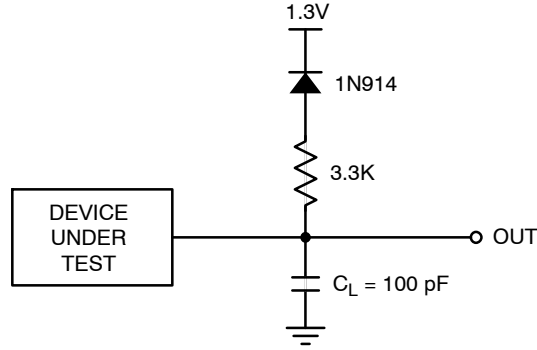

Figure 2. A.C. Testing Input/Output Waveform (Note 11)

11. Input rise and fall times (10% and 90%) < 10 ns.



$C_L$  INCLUDES JIG CAPACITANCE

Figure 3. A.C. Testing Load Circuit (example)

Table 7. A.C. CHARACTERISTICS, WRITE CYCLE ( $V_{CC} = 5 V \pm 10\%$ , unless otherwise specified.)

Symbol	Parameter	28C16A-90		28C16A-12		28C16A-20		Units
		Min	Max	Min	Max	Min	Max	
$t_{WC}$	Write Cycle Time		5		5		10	ms
$t_{AS}$	Address Setup Time	0		0		10		ns
$t_{AH}$	Address Hold Time	100		100		100		ns
$t_{CS}$	$\overline{CE}$ Setup Time	0		0		0		ns
$t_{CH}$	$\overline{CE}$ Hold Time	0		0		0		ns
$t_{CW}$ (Note 12)	$\overline{CE}$ Pulse Time	110		110		150		ns
$t_{OES}$	$\overline{OE}$ Setup Time	0		0		15		ns
$t_{OEH}$	$\overline{OE}$ Hold Time	0		0		15		ns
$t_{WP}$ (Note 12)	$\overline{WE}$ Pulse Width	110		110		150		ns
$t_{DS}$	Data Setup Time	60		60		50		ns
$t_{DH}$	Data Hold Time	0		0		10		ns
$t_{DL}$	Data Latch Time	5	10	5	10	50		ns
$t_{INIT}$ (Note 13)	Write Inhibit Period After Power-up	0.05	100	0.05	100	5	20	ms

12. A write pulse of less than 20 ns duration will not initiate a write cycle.

13. This parameter is tested initially and after a design or process change that affects the parameter.

# CAT28C16A

## DEVICE OPERATION

### Read

Data stored in the CAT28C16A is transferred to the data bus when  $\overline{WE}$  is held high, and both  $\overline{OE}$  and  $\overline{CE}$  are held low. The data bus is set to a high impedance state when either  $\overline{CE}$  or  $\overline{OE}$  goes high. This 2-line control architecture can be used to eliminate bus contention in a system environment.

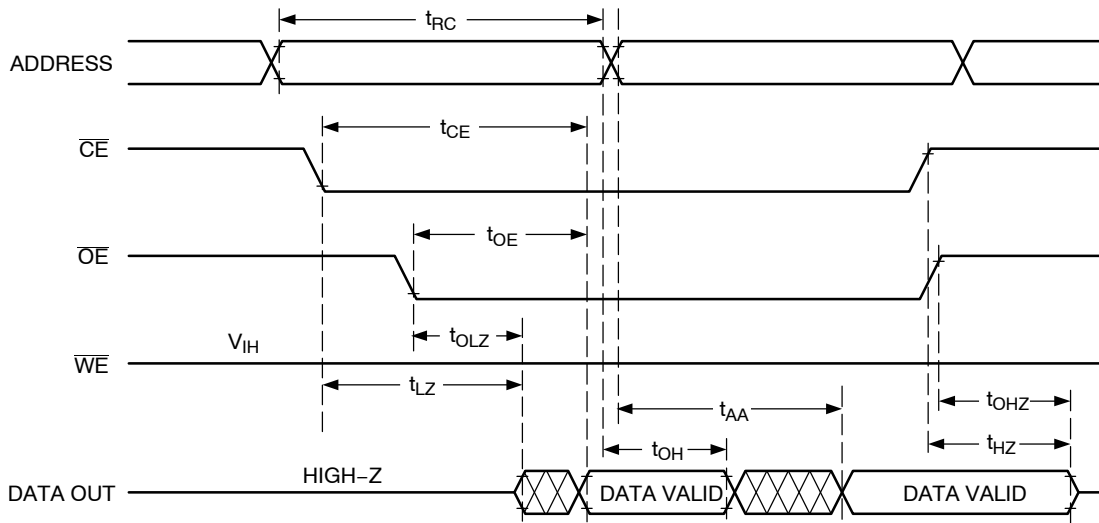

Figure 4. Read Cycle

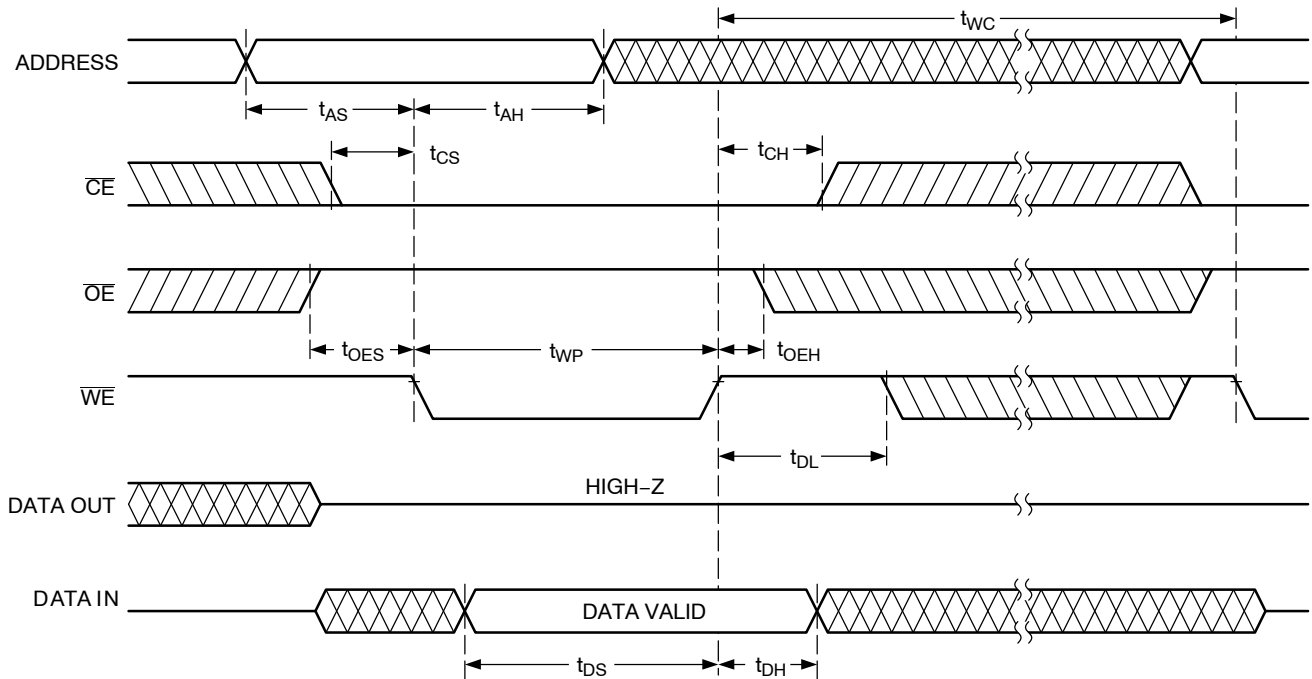

Figure 5. Byte Write Cycle [ $\overline{WE}$  Controlled]

### Byte Write

A write cycle is executed when both  $\overline{CE}$  and  $\overline{WE}$  are low, and  $\overline{OE}$  is high. Write cycles can be initiated using either  $\overline{WE}$  or  $\overline{CE}$ , with the address input being latched on the falling

edge of  $\overline{WE}$  or  $\overline{CE}$ , whichever occurs last. Data, conversely, is latched on the rising edge of  $\overline{WE}$  or  $\overline{CE}$ , whichever occurs first. Once initiated, a byte write cycle automatically erases the addressed byte and the new data is written within 10 ms.

# CAT28C16A

## DATA Polling

DATA polling is provided to indicate the completion of a byte write cycle. Once a byte write cycle is initiated, attempting to read the last byte written will output the

complement of that data on I/O<sub>7</sub> (I/O<sub>0</sub>–I/O<sub>6</sub> are indeterminate) until the programming cycle is complete. Upon completion of the self-timed byte write cycle, all I/O's will output true data during a read cycle.

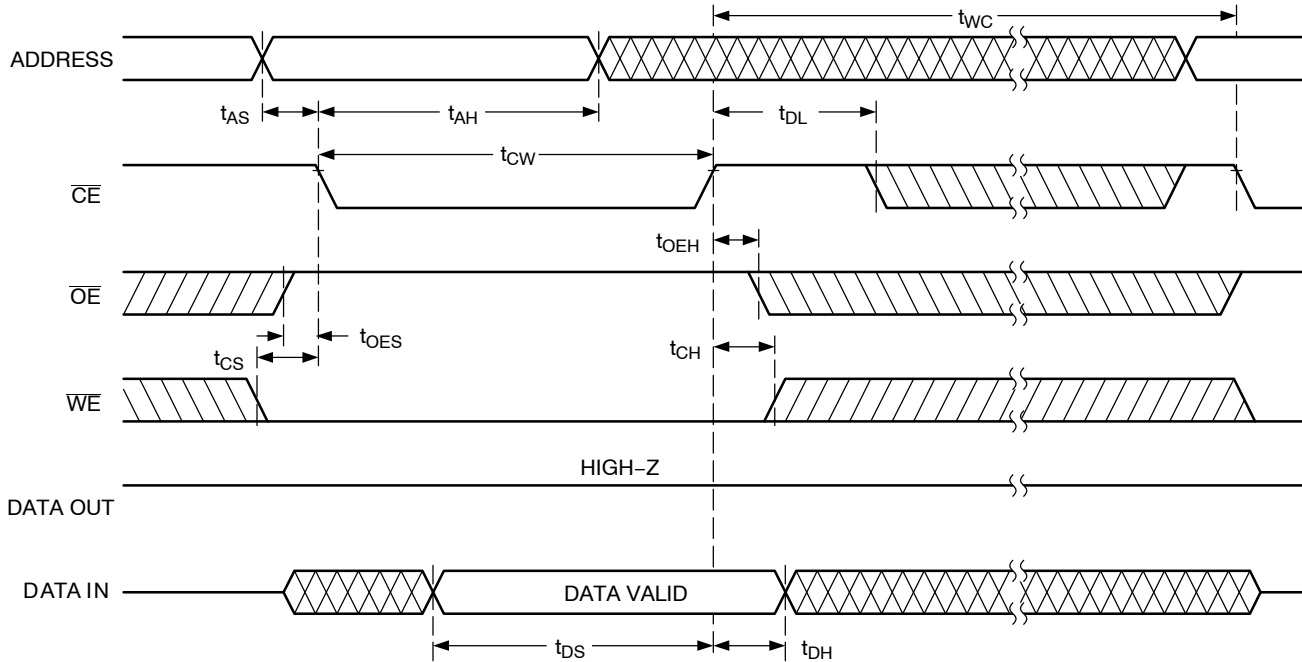

Figure 6. Byte Write Cycle [ $\overline{CE}$  Controlled]

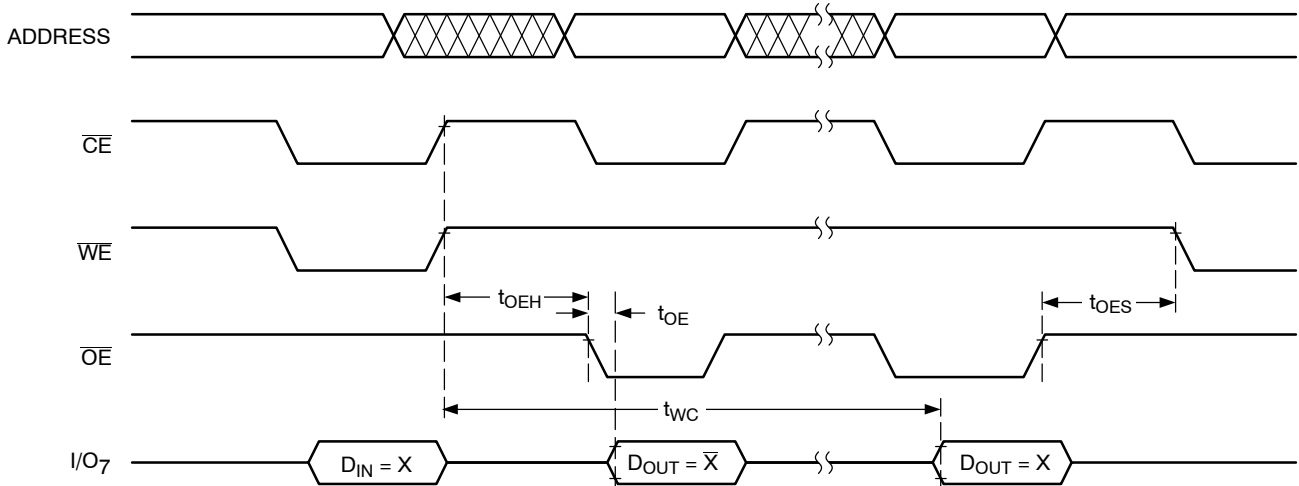

Figure 7. DATA Polling

## Hardware Data Protection

The following is a list of hardware data protection features that are incorporated into the CAT28C16A.

1.  $V_{CC}$  sense provides for write protection when  $V_{CC}$  falls below 3.0 V min.
2. A power on delay mechanism,  $t_{INIT}$  (see AC characteristics), provides a 5 to 20 ms delay before

a write sequence, after  $V_{CC}$  has reached 3.0 V min.

3. Write inhibit is activated by holding any one of  $\overline{OE}$  low,  $\overline{CE}$  high or  $\overline{WE}$  high.
4. Noise pulses of less than 20 ns on the  $\overline{WE}$  or  $\overline{CE}$  inputs will not result in a write cycle.

# CAT28C16A

## PACKAGE DIMENSIONS

PLCC 32  
CASE 776AK-01  
ISSUE O

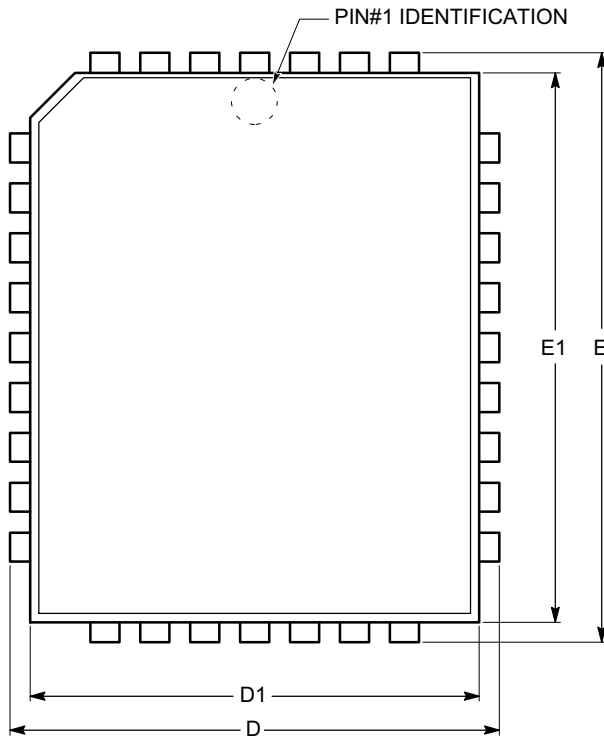

TOP VIEW

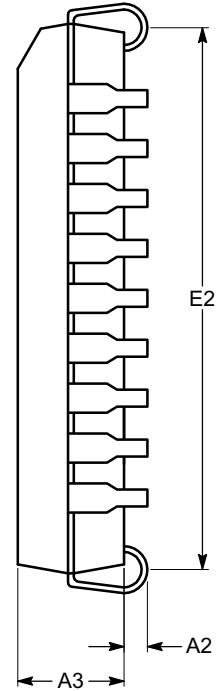

END VIEW

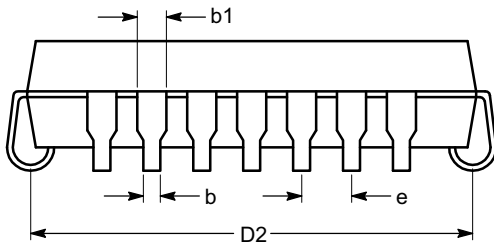

SIDE VIEW

**Notes:**

- (1) All dimensions are in millimeters.
- (2) Complies with JEDEC MS-016.

SYMBOL	MIN	NOM	MAX
A2	0.38		
A3	2.54		2.80
b	0.33		0.54
b1	0.66		0.82
D	12.32		12.57
D1	11.36		11.50
D2	9.56		11.32
E	14.86		15.11
E1	13.90		14.04
E2	12.10		13.86
e	1.27 BSC		

# CAT28C16A

## PACKAGE DIMENSIONS

SOIC-24, 300 mils  
CASE 751BK-01  
ISSUE O

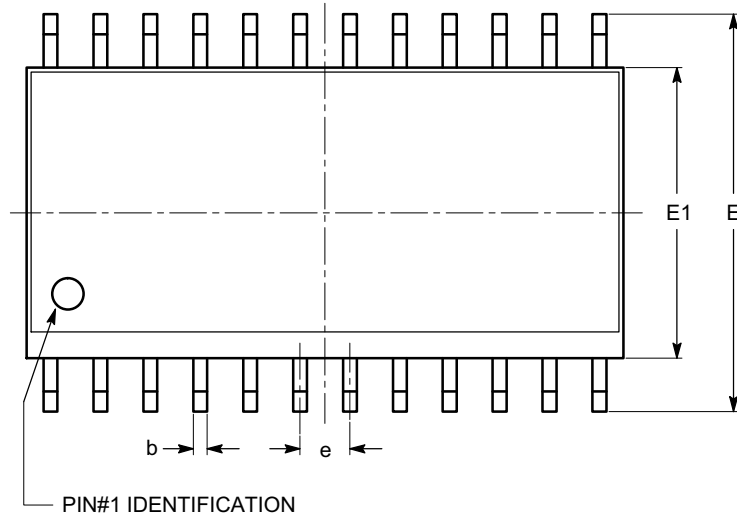

TOP VIEW

SYMBOL	MIN	NOM	MAX
A	2.35		2.65
A1	0.10		0.30
A2	2.05		2.55
b	0.31		0.51
c	0.20		0.33
D	15.20		15.40
E	10.11		10.51
E1	7.34		7.60
e	1.27 BSC		
h	0.25		0.75
L	0.40		1.27
$\theta$	0°		8°
$\theta 1$	5°		15°

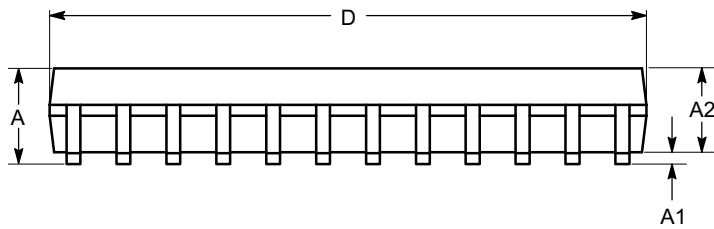

SIDE VIEW

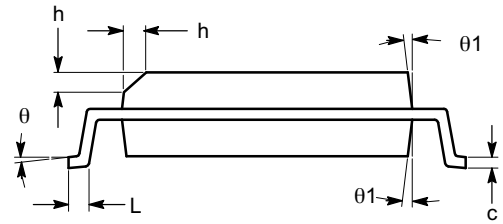

END VIEW

**Notes:**

- (1) All dimensions are in millimeters. Angles in degrees.
- (2) Complies with JEDEC MS-013.



# CAT28C16A

## PACKAGE DIMENSIONS

PDIP-24, 600 mils  
CASE 646AD-01  
ISSUE A

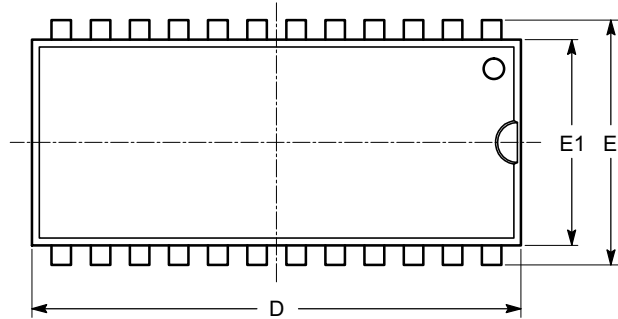

TOP VIEW

SYMBOL	MIN	NOM	MAX
A			6.35
A1	0.39		
A2	3.18		4.95
b	0.36		0.55
b1	0.77		1.77
c	0.21		0.38
D	31.50		32.25
E	15.24		15.87
E1	12.32		14.73
e	2.54 BSC		
eB	15.24		17.78
L	2.93		5.08

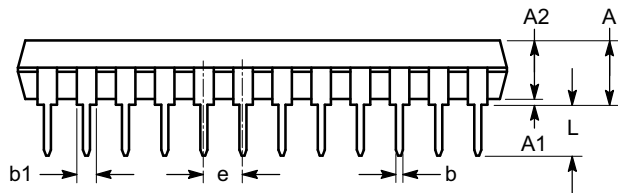

SIDE VIEW

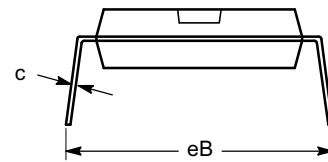

END VIEW

**Notes:**

- (1) All dimensions are in millimeters.
- (2) Complies with JEDEC MS-011.

# CAT28C16A

## Example of Ordering Information

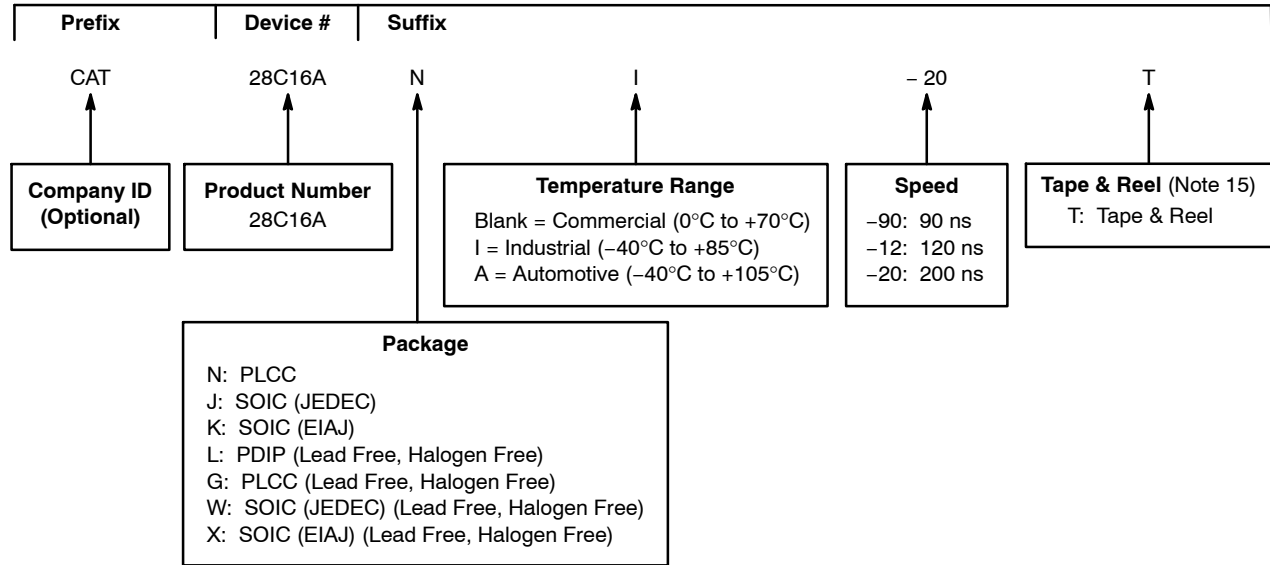

14. The device used in the above example is a CAT28C16ANI-20T (PLCC, Industrial Temperature, 200 ns Access Time, Tape & Reel).

15. For information on tape and reel specifications, including part orientation and tape sizes, please refer to our Tape and Reel Packaging Specifications Brochure, BRD8011/D.

ON Semiconductor and  are registered trademarks of Semiconductor Components Industries, LLC (SCILLC). SCILLC reserves the right to make changes without further notice to any products herein. SCILLC makes no warranty, representation or guarantee regarding the suitability of its products for any particular purpose, nor does SCILLC assume any liability arising out of the application or use of any product or circuit, and specifically disclaims any and all liability, including without limitation special, consequential or incidental damages. "Typical" parameters which may be provided in SCILLC data sheets and/or specifications can and do vary in different applications and actual performance may vary over time. All operating parameters, including "Typicals" must be validated for each customer application by customer's technical experts. SCILLC does not convey any license under its patent rights nor the rights of others. SCILLC products are not designed, intended, or authorized for use as components in systems intended for surgical implant into the body, or other applications intended to support or sustain life, or for any other application in which the failure of the SCILLC product could create a situation where personal injury or death may occur. Should Buyer purchase or use SCILLC products for any such unintended or unauthorized application, Buyer shall indemnify and hold SCILLC and its officers, employees, subsidiaries, affiliates, and distributors harmless against all claims, costs, damages, and expenses, and reasonable attorney fees arising out of, directly or indirectly, any claim of personal injury or death associated with such unintended or unauthorized use, even if such claim alleges that SCILLC was negligent regarding the design or manufacture of the part. SCILLC is an Equal Opportunity/Affirmative Action Employer. This literature is subject to all applicable copyright laws and is not for resale in any manner.

## PUBLICATION ORDERING INFORMATION

### LITERATURE FULFILLMENT:

Literature Distribution Center for ON Semiconductor  
 P.O. Box 5163, Denver, Colorado 80217 USA  
**Phone:** 303-675-2175 or 800-344-3860 Toll Free USA/Canada  
**Fax:** 303-675-2176 or 800-344-3867 Toll Free USA/Canada  
**Email:** orderlit@onsemi.com

**N. American Technical Support:** 800-282-9855 Toll Free  
 USA/Canada  
**Europe, Middle East and Africa Technical Support:**  
 Phone: 421 33 790 2910  
**Japan Customer Focus Center**  
 Phone: 81-3-5773-3850

**ON Semiconductor Website:** [www.onsemi.com](http://www.onsemi.com)

**Order Literature:** <http://www.onsemi.com/orderlit>

For additional information, please contact your local Sales Representative