



4-Channel Constant Current LED Driver with EZDim™

FEATURES

- Four LED current sinks with tight matching
- Low Dropout Driver 130mV at 30mA
- No switching noise
- Shutdown current < 1µA
- LED current set by external resistor
- Dimming via 1-wire EZDim™ interface
- Thermal shutdown protection
- RoHS Compliant
- 8-lead 2mm x 3mm TDFN package

APPLICATIONS

- LCD Display Backlight
- Cellular Phones
- Digital Still Cameras
- Handheld Devices

DESCRIPTION

The CAT4004 provides four matched low dropout current sources to drive LEDs. An external resistor on RSET sets the current in the LED channels. Each LED channel includes an individual control loop allowing the device to handle a wide range of LED forward voltages while still maintaining tight current matching.

The EN/DIM logic inputs supports device enable and a digital dimming interface for current setting of all LEDs. Six different current dimming ratios are available.

The device is aimed at “direct drive” battery applications. It is required that the battery or voltage source have enough headroom to drive the LED forward voltage and current sink (>150mV).

The device is available in a tiny 8-lead TDFN 2mm x 3mm package with a max height of 0.8mm.

www.DataSheet4U.com

ORDERING INFORMATION

Part Number	Package	Package Marking
CAT4004VP2-T3	TDFN-8 2x3mm ⁽¹⁾	FT

Notes:

- (1) Lead finish Matte-Tin
- (2) Quantity per reel is 3000

For Ordering Information details, see page 10.

PIN CONFIGURATION

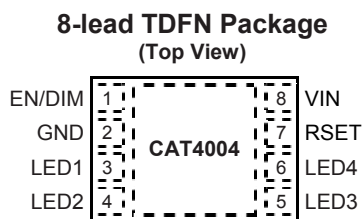

TYPICAL APPLICATION CIRCUIT

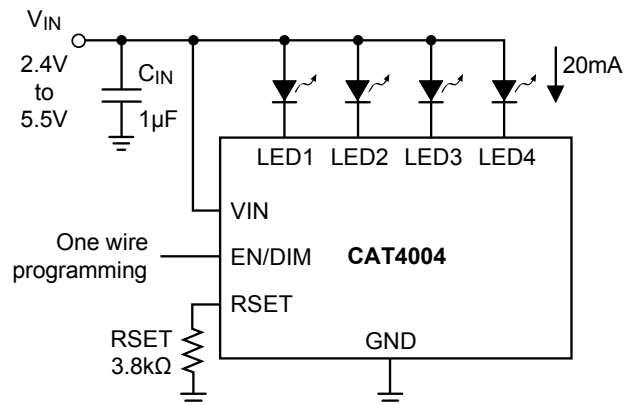

ABSOLUTE MAXIMUM RATINGS

Parameter	Rating	Unit
V _{IN} , LEDx, RSET	6	V
EN/DIM Voltage	V _{IN} + 0.7	V
Storage Temperature Range	-65 to +160	°C
Junction Temperature Range	-40 to +125	°C
Lead Temperature	300	°C

RECOMMENDED OPERATING CONDITIONS

Parameter	Rating	Unit
V _{IN}	2.4 to 5.5 ⁽¹⁾	V
Ambient Temperature Range	-40 to +85	°C
I _{LED} per LED pin	0 to 40	mA

Typical application circuit with external components is shown on page 1.

ELECTRICAL OPERATING CHARACTERISTICS

(over recommended operating conditions unless specified otherwise) V_{IN} = 4.0V, EN = High, T_{AMB} = 25°C

Symbol	Name	Conditions	Min	Typ	Max	Units
I _Q	Quiescent Current	No load, RSET = Float No load, RSET = 4.8kΩ		0.6 1.0		mA mA
I _{QSHDN}	Shutdown Current	V _{EN} = 0V			1	μA
I _{LED-ACC}	LED Current Accuracy	1mA ≤ I _{LED} ≤ 40mA		±1		%
I _{LED-DEV}	LED Channel Matching	$\frac{I_{LED} - I_{LEDAVG}}{I_{LED}}$	-5	±1	+5	%
V _{DOUT}	Dropout Voltage	I _{LED} = 30mA		130		mV
R _{EN/DIM} V _{HI} V _{LO}	EN/DIM Pin <ul style="list-style-type: none"> • Internal pull-down resistor • Logic High Level • Logic Low Level 		1.3	100	0.4	kΩ V V
T _{SD}	Thermal Shutdown			150		°C
T _{HYS}	Thermal Hysteresis			20		°C
V _{UVLO}	Undervoltage lockout (UVLO) threshold			1.8		V

RECOMMENDED EN/DIM TIMING

For $2.4 \leq V_{IN} \leq 5.5V$, over full ambient temperature range $-40^{\circ}C$ to $+85^{\circ}C$.

Symbol	Name	Conditions	Min	Typ	Max	Units
T_{SETUP}	EN/DIM setup from shutdown		10			μs
T_{LO}	EN/DIM program low time		0.2		100	μs
T_{HI}	EN/DIM program high time		0.2			μs
T_{PWRDWN}	EN/DIM low time to shutdown		1.5			ms
T_{LED}	LED current settling time			40		μs

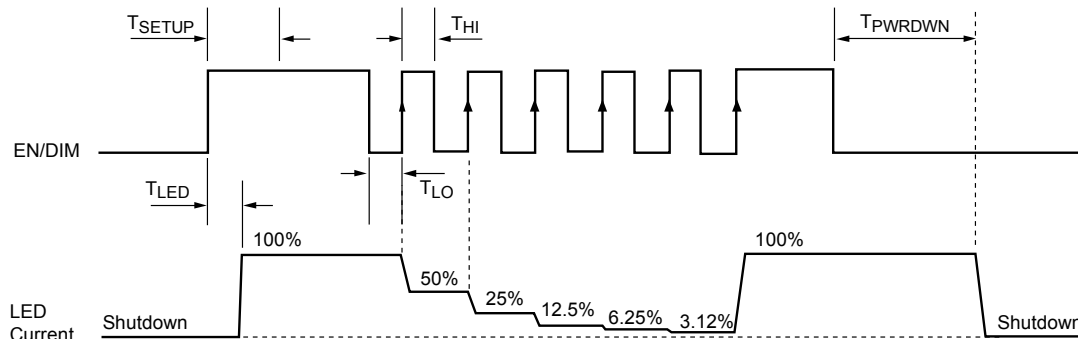

Figure 1. EN/DIM Dimming Timing Diagram

EN/DIM number of pulses *	R_{SET} Gain	LED Current
LOW	Shutdown mode	Zero
Transitions HIGH	132	$132 \times 0.6V/R_{SET}$
1 st	66	$66 \times 0.6V/R_{SET}$
2 nd	33	$33 \times 0.6V/R_{SET}$
3 rd	16.5	$16.5 \times 0.6V/R_{SET}$
4 th	8.25	$8.25 \times 0.6V/R_{SET}$
5 th	4.125	$4.125 \times 0.6V/R_{SET}$
6 th	132	$132 \times 0.6V/R_{SET}$
x th	Device will keep cycling through gain selection	$GAIN \times 0.6V/R_{SET}$

* The gain is changed on the rising edges of the EN/DIM input.

LED CURRENT SELECTION

At power-up, the initial LED current is set to full scale (100% brightness) by the external resistor R_{SET} as follows:

$$\text{LED current} = 132 \times \frac{0.6V}{R_{SET}}$$

The EN/DIM pin has two primary functions. One function enables and disables the device. The other function is LED current dimming with six different

levels by pulsing the input signal, as shown on Figure 3. On each consecutive pulse rising edge, the LED current is divided by half to 50%, then 25%, 12.5%, 6.25% and 3.125% dimming levels. Pulses faster than the minimum T_{LO} may be ignored and filtered by the device. Pulses longer than the maximum T_{LO} may shutdown the device.

The LED driver enters a “zero current” shutdown mode if EN/DIM is held low for 1.5ms or more.

CAT4004

TYPICAL PERFORMANCE CHARACTERISTICS

$V_{IN} = 4V$, $V_F = 3.3V$, $I_{OUT} = 80mA$ (4 LEDs at 20mA), $C_{IN} = 1\mu F$, $T_{AMB} = 25^\circ C$ unless otherwise specified.

Quiescent Current vs. Input Voltage

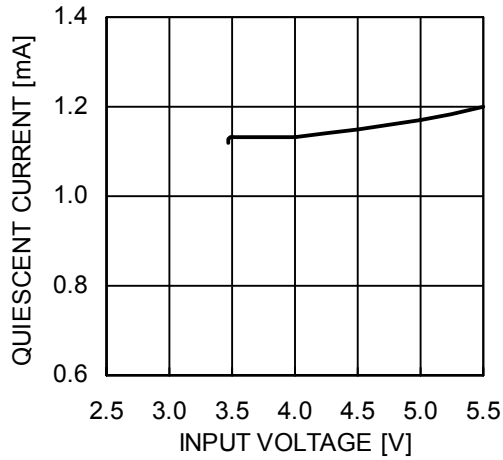

Quiescent Current vs. Temperature

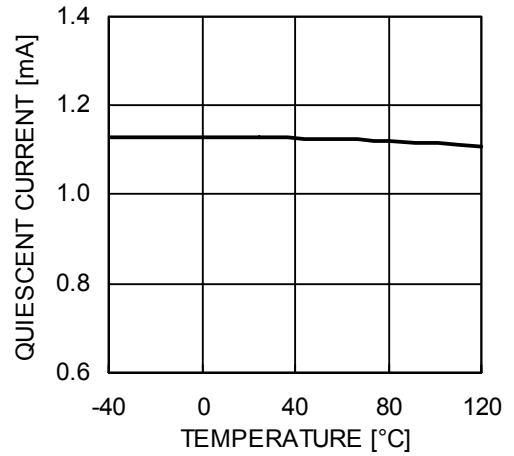

LED Current Change vs. Input Voltage

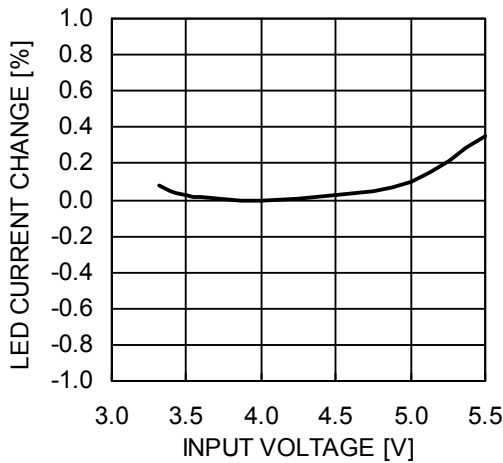

LED Current Change vs. Temperature

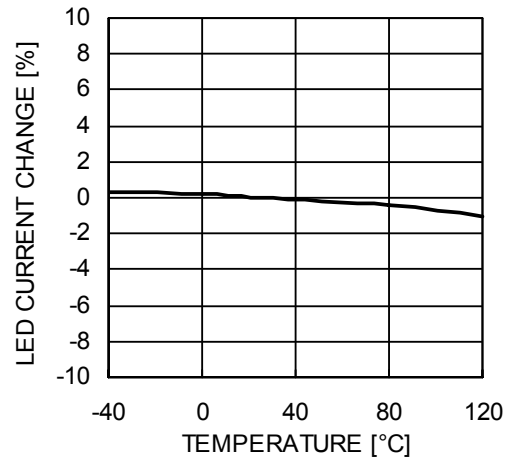

LED Current vs. RSET Resistor

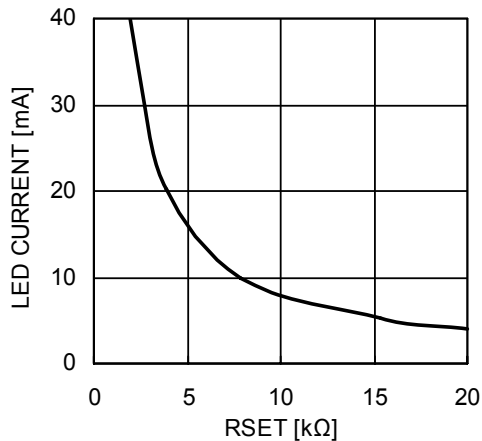

TYPICAL PERFORMANCE CHARACTERISTICS

$V_{IN} = 4V$, $V_F = 3.3V$, $I_{OUT} = 80mA$ (4 LEDs at 20mA), $C_{IN} = 1\mu F$, $T_{AMB} = 25^\circ C$ unless otherwise specified.

RSET Pin Voltage vs. Input Voltage

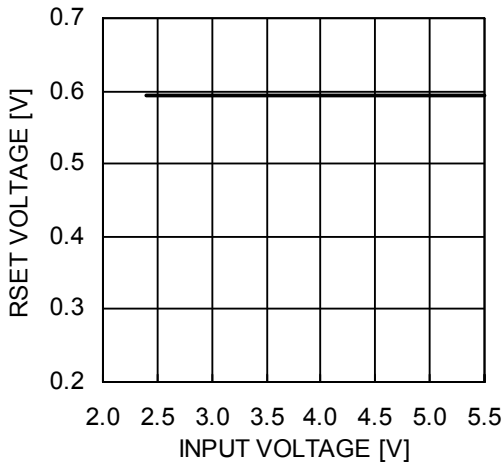

RSET Pin Voltage vs. Temperature

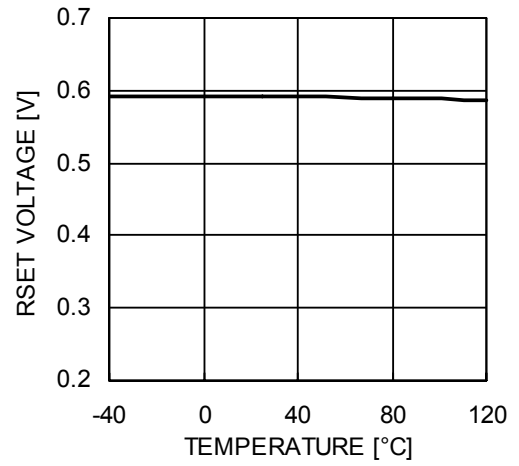

LED Current vs. LED Pin Voltage

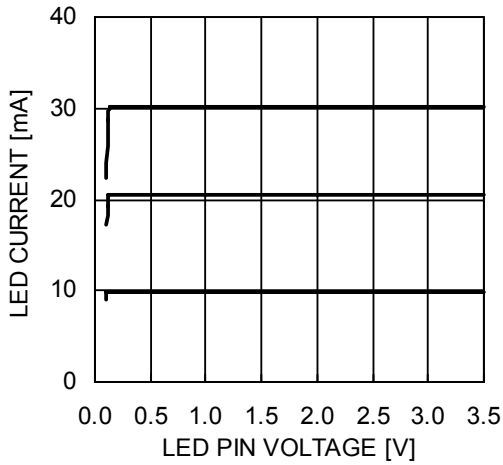

Dropout Characteristics

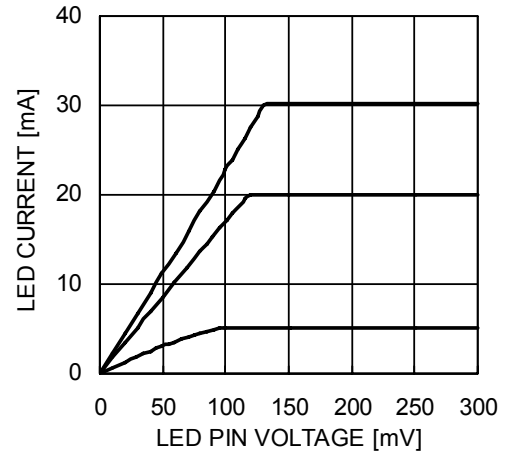

Efficiency vs. Input Voltage

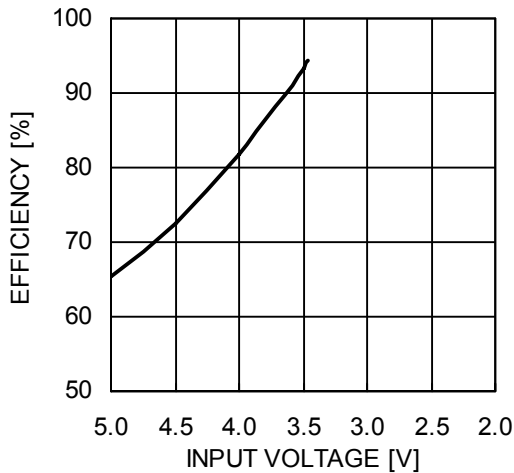

TYPICAL PERFORMANCE CHARACTERISTICS

$V_{IN} = 4V$, $V_F = 3.3V$, $I_{OUT} = 80mA$ (4 LEDs at 20mA), $C_{IN} = 1\mu F$, $T_{AMB} = 25^\circ C$ unless otherwise specified.

Power Up Waveform

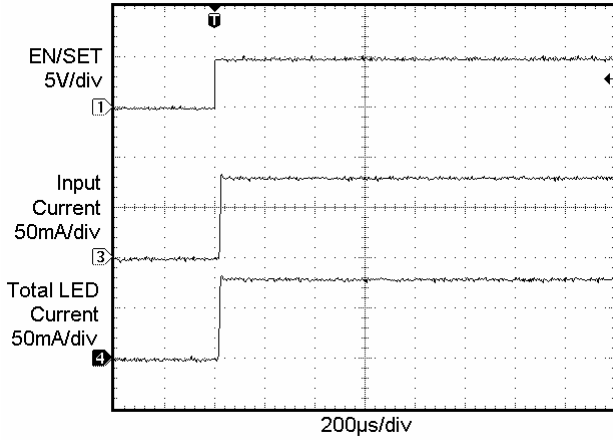

Power Down Waveform

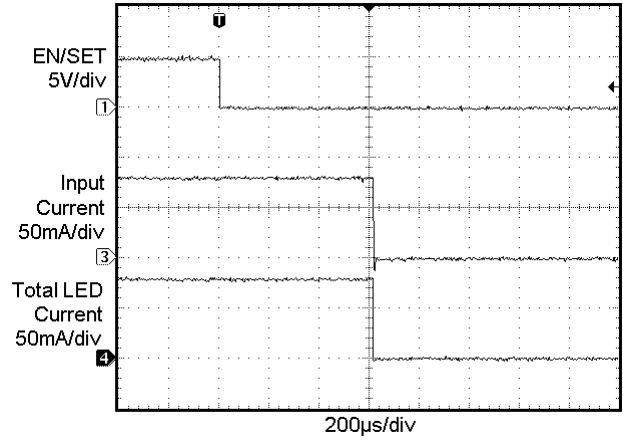

Line Transient Waveform 4V to 5.5V

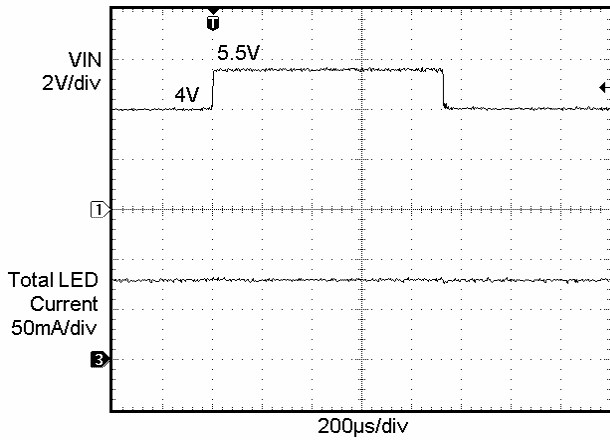

Dimming Waveform 80mA to 40mA

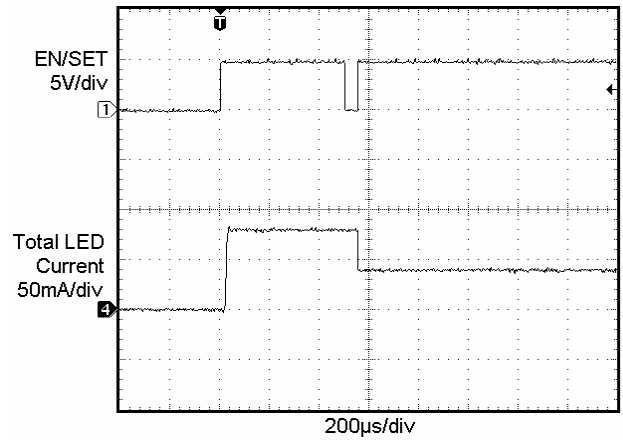

PIN DESCRIPTIONS

Pin #	Name	Function
1	EN/DIM	Device enable (active high) and dimming control
2	GND	Ground reference
3	LED1	LED1 cathode terminal
4	LED2	LED2 cathode terminal
5	LED3	LED3 cathode terminal
6	LED4	LED4 cathode terminal
7	RSET	RSET external LED mirror gain 128
8	VIN	Device supply input, connect to battery or supply
TAB	TAB	Connect to GND on the PCB

PIN FUNCTION

VIN is the supply pin for the charge pump. A small 1 μ F ceramic bypass capacitor is required between the VIN pin and ground near the device. The operating input voltage range is from 2.5V to 5.5V. Whenever the input supply falls below the under-voltage threshold (1.8V), all the LED channels are disabled and the device enters shutdown mode.

EN/DIM is the enable and one wire dimming input for all LED channels. Levels of logic high and logic low are set at 1.3V and 0.4V respectively. When EN/DIM is initially taken high, the device becomes enabled and all LED currents are set to the full scale according to the resistor R_{SET} . To place the device into “zero current” shutdown mode, the EN/DIM pin must be held low for at least 1.5ms.

LED1 to LED4 provide the internal regulated current for each of the LED cathodes. These pins enter a high

impedance zero current state whenever the device is placed in shutdown mode.

RSET is connected to the resistor (R_{SET}) to set the full scale current for the LEDs. The voltage at this pin is regulated to 0.6V. The ground side of the external resistor should be star connected back to the GND of the PCB. In shutdown mode, RSET becomes high impedance.

GND is the ground reference for the device. The pin must be connected to the ground plane on the PCB.

TAB is the exposed pad underneath the package. For best thermal performance, the tab should be soldered to the PCB and connected to the ground plane.

BLOCK DIAGRAM

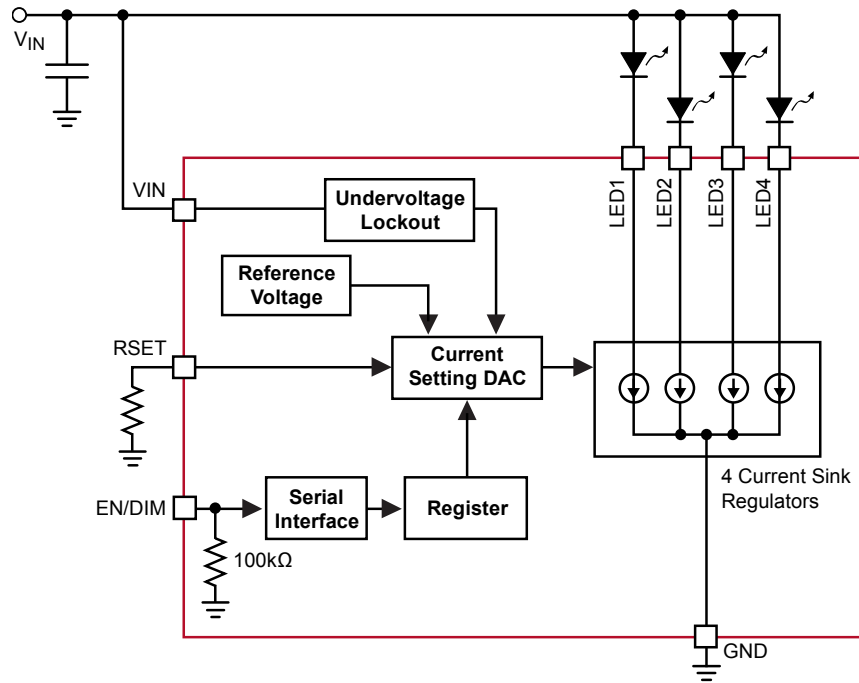

Figure 2. CAT4004 Functional Block Diagram

BASIC OPERATION

The CAT4004 uses four tightly matched current sinks to accurately regulate LED current in each channel proportional to the current sourced from the RSET pin.

$$I_{LED} = GAIN \times \frac{0.6V}{R_{SET}}$$

There are six different gain settings for LED brightness that can be set through the EN/DIM pin. The default gain on power-up is 132. Tight current regulation for all channels is possible over a wide range of input and LED voltages due to independent current sensing circuitry on each channel.

Each LED channel needs a minimum of 150mV headroom to sink constant regulated current. If the input supply falls below 1.8V, the under-voltage lockout circuit disables all LED channels and resets the circuit to default values. Any unused LED channels should be left open.

PACKAGE OUTLINES

8 LEAD TDFN (VP2) 2mm x 3mm

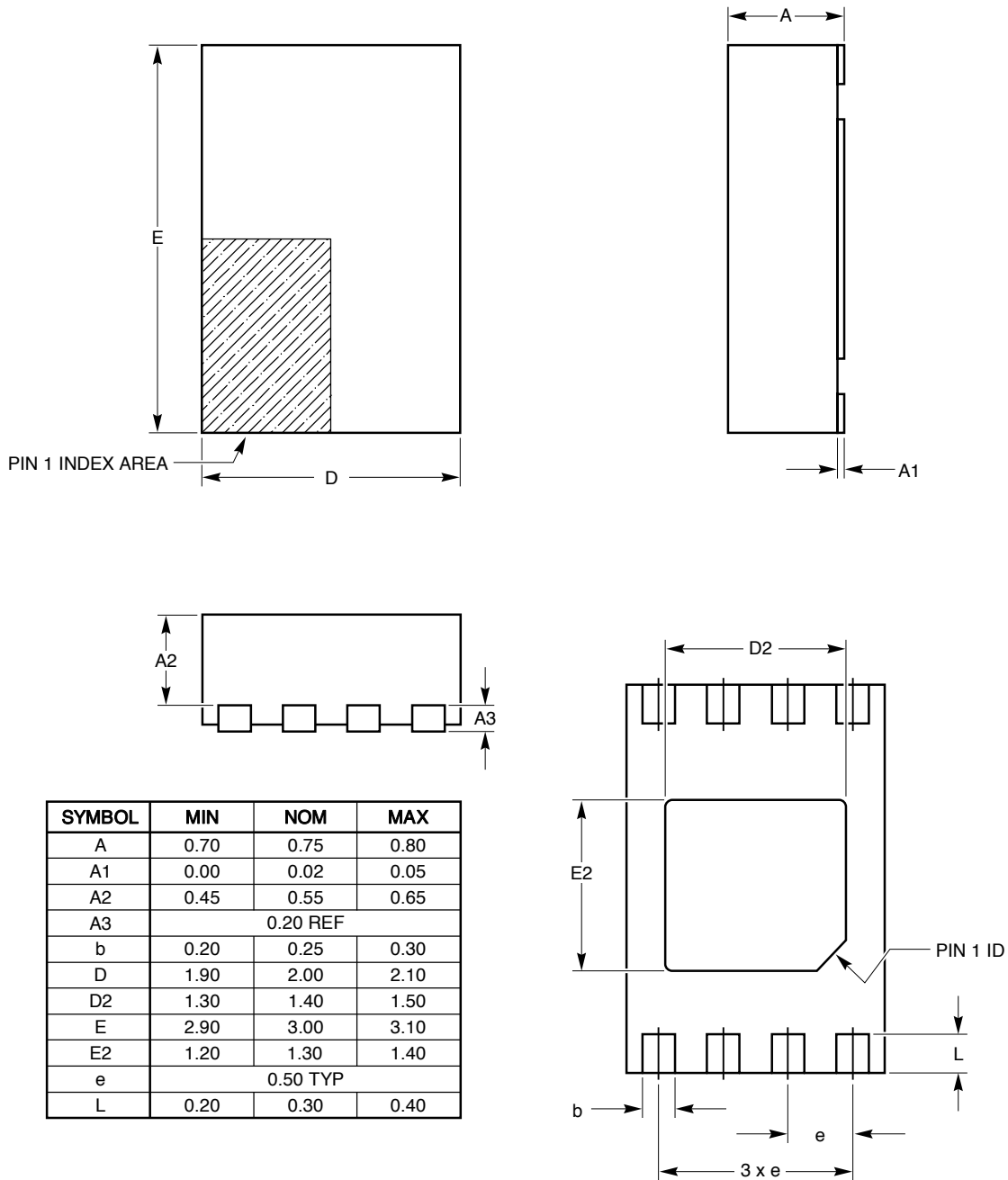

For current Tape & Reel information, download the pdf file from:
<http://www.catsemi.com/documents/tapeandreeel.pdf>

Notes:

- (1) All dimensions are in millimeters, angles in degrees.
- (2) Complies with JEDEC Standard MO-229

EXAMPLE OF ORDERING INFORMATION

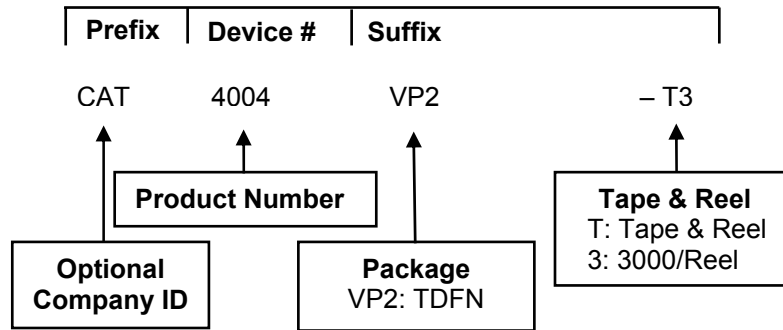

Notes:

- (1) All packages are RoHS-compliant (Lead-free, Halogen-free).
- (2) The standard lead finish is Matte-Tin.
- (3) The device used in the above example is a CAT4004VP2-T3 (TDFN, Tape & Reel).
- (4) For additional package and temperature options, please contact your nearest Catalyst Semiconductor Sales office.

REVISION HISTORY

Date	Rev.	Reason
03/15/2007	A	Initial Issue

Copyrights, Trademarks and Patents

Trademarks and registered trademarks of Catalyst Semiconductor include each of the following:

Beyond Memory™, DPP™, EZDim™, LDD™, MiniPot™, and Quad-Mode™

Catalyst Semiconductor has been issued U.S. and foreign patents and has patent applications pending that protect its products.

CATALYST SEMICONDUCTOR MAKES NO WARRANTY, REPRESENTATION OR GUARANTEE, EXPRESS OR IMPLIED, REGARDING THE SUITABILITY OF ITS PRODUCTS FOR ANY PARTICULAR PURPOSE, NOR THAT THE USE OF ITS PRODUCTS WILL NOT INFRINGE ITS INTELLECTUAL PROPERTY RIGHTS OR THE RIGHTS OF THIRD PARTIES WITH RESPECT TO ANY PARTICULAR USE OR APPLICATION AND SPECIFICALLY DISCLAIMS ANY AND ALL LIABILITY ARISING OUT OF ANY SUCH USE OR APPLICATION, INCLUDING BUT NOT LIMITED TO, CONSEQUENTIAL OR INCIDENTAL DAMAGES.

Catalyst Semiconductor products are not designed, intended, or authorized for use as components in systems intended for surgical implant into the body, or other applications intended to support or sustain life, or for any other application in which the failure of the Catalyst Semiconductor product could create a situation where personal injury or death may occur.

Catalyst Semiconductor reserves the right to make changes to or discontinue any product or service described herein without notice. Products with data sheets labeled "Advance Information" or "Preliminary" and other products described herein may not be in production or offered for sale.

Catalyst Semiconductor advises customers to obtain the current version of the relevant product information before placing orders. Circuit diagrams illustrate typical semiconductor applications and may not be complete.



Catalyst Semiconductor, Inc.
Corporate Headquarters
2975 Stender Way
Santa Clara, CA 95054
Phone: 408.542.1000
Fax: 408.542.1200
www.catsemi.com

Document No: 5024
Revision: A
Issue date: 03/15/07