



150mA CMOS LDO Regulator

FEATURES

- Guaranteed 150mA output current
- Low dropout voltage of 90mV typical at 150mA
- Stable with 1 μ F ceramic output capacitor
- External 10nF bypass capacitor for low noise
- Quick-start feature
- No-load ground current of 55 μ A typical
- Full-load ground current of 80 μ A typical
- $\pm 1.0\%$ output voltage initial accuracy
- $\pm 2.0\%$ accuracy over temperature
- “Zero” current shutdown mode
- Current limit and Under voltage lockout
- Thermal protection
- Thin SOT23-5 package

APPLICATIONS

- Cellular phones
- Battery-powered devices
- Consumer Electronics

For Ordering Information details, see page 9.

DESCRIPTION

The CAT6217 is a 150mA CMOS low dropout regulator that provides fast response time during load current and line voltage changes.

The quick-start feature allows the use of an external bypass capacitor to reduce the overall output noise without affecting the turn-on time of just 150 μ s.

With zero shutdown current and low ground current of 55 μ A typical, the CAT6217 is ideal for battery-operated devices with supply voltages from 2.3V to 5.5V. An internal under voltage lockout circuit disables the output at supply voltages under 2.1V typical.

The CAT6217 offers 1% initial accuracy and low dropout voltage, 90mV typical at 150mA. Stable operation is provided with a 1 μ F ceramic capacitor, reducing required board space and component cost.

Other features include output short-circuit current limit and thermal protection.

The device is available in the low profile (1mm max height) 5-lead thin SOT23 package.

PIN CONFIGURATION

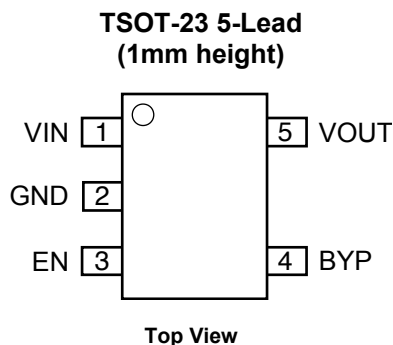

TYPICAL APPLICATION CIRCUIT

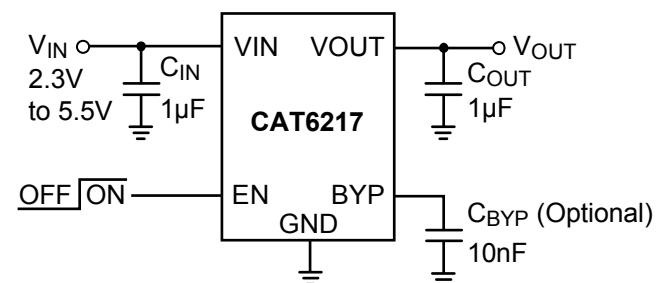

PIN DESCRIPTIONS

Pin #	Name	Function
1	VIN	Supply voltage input.
2	GND	Ground reference.
3	EN	Enable input (active high); a 2.5MΩ pull-down resistor is provided.
4	BYP	Optional bypass capacitor connection for noise reduction and PSRR enhancing.
5	VOUT	LDO Output Voltage.

BLOCK DIAGRAM

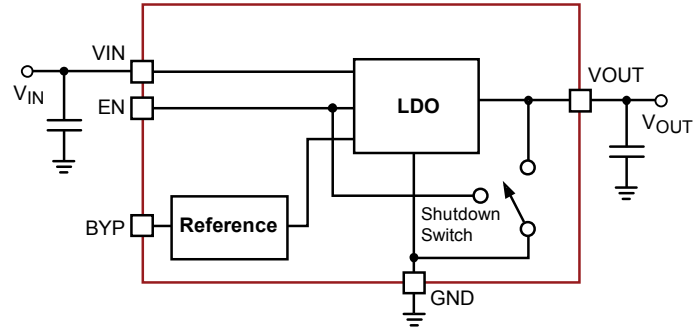

Figure 2. CAT6217 Functional Block Diagram

PIN FUNCTION

VIN is the supply pin for the LDO. A small 1μF ceramic bypass capacitor is required between the VIN pin and ground near the device. When using longer connections to the power supply, CIN value can be increased without limit. The operating input voltage range is from 2.3V to 5.5V.

EN is the enable control logic (active high) for the regulator output. It has a 2.5MΩ pull-down resistor, which assures that if EN pin is left open, the circuit is disabled.

VOUT is the LDO regulator output. A small 1μF ceramic bypass capacitor is required between the VOUT pin and ground for stability. For better transient response, its value can be increased to 4.7μF.

The capacitor should be located near the device. ESR domain is 5mΩ to 500mΩ. VOUT can deliver a maximum guaranteed current of 150mA. A 250Ω internal shutdown switch discharges the output capacitor in the no-load condition.

GND is the ground reference for the LDO. The pin must be connected to the ground plane on the PCB.

BYP is the reference bypass pin. An optional 0.01μF capacitor can be connected between BYP pin and GND to reduce the output noise and enhance the PSRR at high frequency.

ABSOLUTE MAXIMUM RATINGS (1)

Parameter	Rating	Unit
VIN	0 to 6.5	V
VEN, VOUT	-0.3 to VIN+0.3	V
Junction Temperature, TJ	+150	°C
Power Dissipation, PD	Internally Limited (2)	mW
Storage Temperature Range, TS	-65 to +150	°C
Lead Temperature (soldering, 5 sec.)	260	°C
ESD Rating (Human Body Model)	3	kV

RECOMMENDED OPERATING CONDITIONS (3)

Parameter	Range	Unit
VIN	2.3 to 5.5	V
VEN	0 to VIN	V
Junction Temperature Range, TJ	-40 to +125	°C
Package Thermal Resistance (SOT23-5), θJA	235	°C/W

Typical application circuit with external components is shown on page 1.

Notes:

- (1) Exceeding maximum rating may damage the device
- (2) The maximum allowable power dissipation at any TA (ambient temperature) is $P_{Dmax} = (T_{Jmax} - T_A)/\theta_{JA}$. Exceeding the maximum allowable power dissipation will result in excessive die temperature, and the regulator will go into thermal shutdown.
- (3) The device is not guaranteed to work outside its operating rating.

ELECTRICAL OPERATING CHARACTERISTICS ⁽¹⁾

$V_{IN} = V_{OUT} + 1.0V$, $V_{EN} = \text{High}$, $I_{OUT} = 100\mu A$, $C_{IN} = C_{OUT} = 1\mu F$, ambient temperature of 25°C (over recommended operating conditions unless specified otherwise). **Bold numbers** apply for the entire junction temperature range.

Symbol	Parameter	Conditions	Min	Typ	Max	Unit
$V_{OUT-ACC}$	Output Voltage Accuracy	Initial accuracy	-1.0		+1.0	%
			-2.0		+2.0	
TC_{OUT}	Output Voltage Temp. Coefficient			40		ppm/°C
V_{R-LINE}	Line Regulation	$V_{IN} = V_{OUT} + 1.0V$ to 5.5V	-0.2	± 0.1	+0.2	%V
			-0.4		+0.4	
V_{R-LOAD}	Load Regulation	$I_{OUT} = 100\mu A$ to 150 mA		0.6	1.0	%
					1.3	
V_{DROP}	Dropout Voltage ⁽²⁾	$I_{OUT} = 150mA$		90	125	mV
					150	
I_{GND}	Ground Current	$I_{OUT} = 0\mu A$		55	75	μA
		$I_{OUT} = 150mA$		80		
I_{GND-SD}	Shutdown Ground Current	$V_{EN} < 0.4V$			1	μA
					2	
PSRR	Power Supply Rejection Ratio	$f = 1kHz$, $C_{BYP} = 10nF$		64		dB
		$f = 20kHz$, $C_{BYP} = 10nF$		54		
I_{SC}	Output short circuit current limit	$V_{OUT} = 0V$		350		mA
T_{ON}	Turn-On Time	$C_{BYP} = 10nF$		150		μs
e_N	Output Noise Voltage ⁽³⁾	BW = 10Hz to 100kHz		45		μV_{rms}
R_{OUT-SH}	Shutdown Switch Resistance			250		Ω
R_{EN}	Enable pull-down resistor			2.5		M Ω
V_{UVLO}	Under-voltage lock out (UVLO) threshold			2.1		V
ESR	C_{OUT} equivalent series resistance		5		500	m Ω
Enable Input						
V_{HI}	Logic High Level	$V_{IN} = 2.3$ to 5.5V	1.8			V
V_{LO}	Logic Low Level	$V_{IN} = 2.3$ to 5.5V			0.4	V
I_{EN}	Enable Input Current	$V_{EN} = 0.4V$		0.15	1	μA
		$V_{EN} = V_{IN}$		1.5	4	
Thermal Protection						
T_{SD}	Thermal Shutdown			160		°C
T_{HYS}	Thermal Hysteresis			10		°C

Notes:

- (1) Specification for 2.85V output version unless specified otherwise.
- (2) Dropout voltage is defined as the input-to-output differential at which the output voltage drops 2% below its nominal value measured at 1V differential. During test, the input voltage stays always above the minimum 2.3V.
- (3) Specification for 1.8V output version.

TYPICAL CHARACTERISTICS (shown for 2.85V output version)

$V_{IN} = 3.85V$, $I_{OUT} = 100\mu A$, $C_{IN} = C_{OUT} = 1\mu F$, $C_{BYP} = 10nF$, $T_A = 25^\circ C$ unless otherwise specified.

Dropout Characteristics

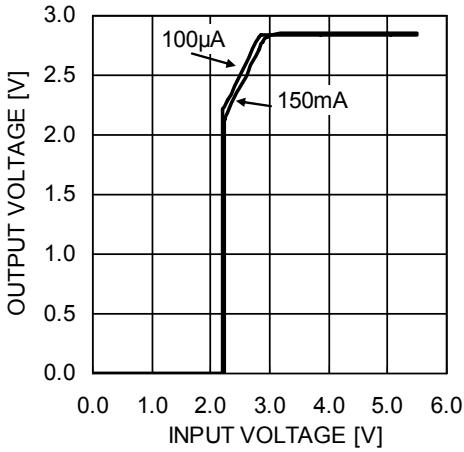

Line Regulation

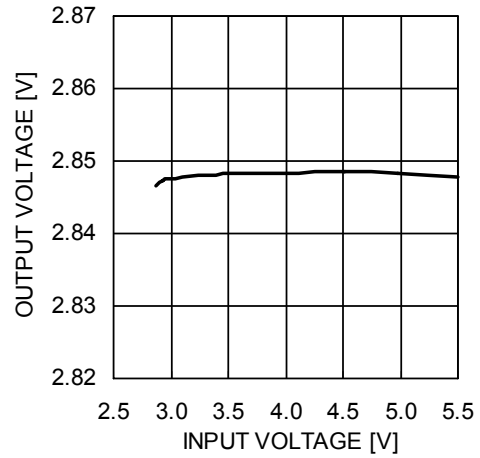

Load Regulation

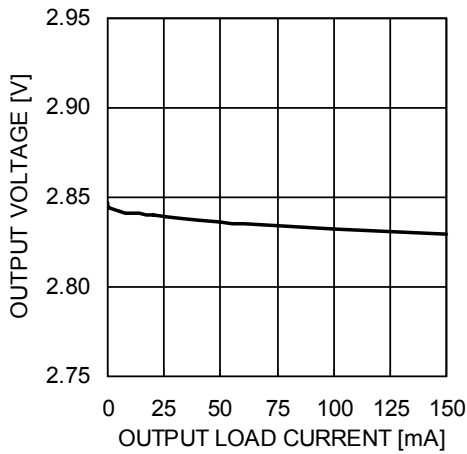

Output Voltage vs. Temperature

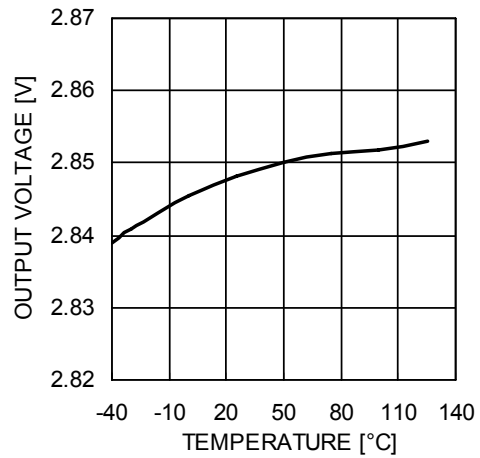

Ground Current vs. Load Current

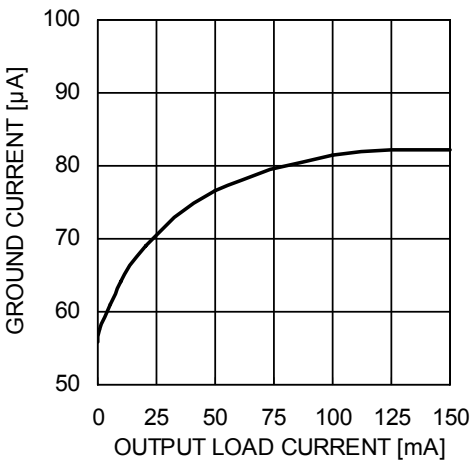

Ground Current vs. Temperature

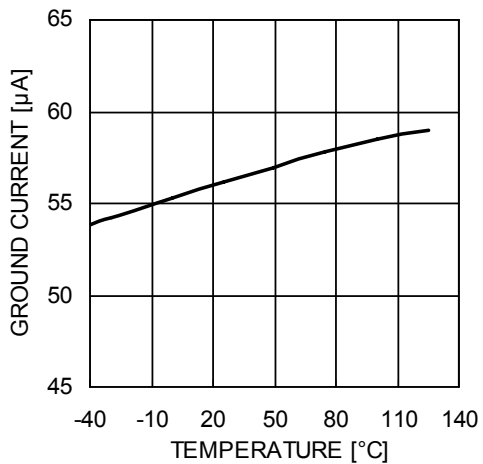

TYPICAL CHARACTERISTICS (shown for 2.85V output option)

$V_{IN} = 3.85V$, $I_{OUT} = 100\mu A$, $C_{IN} = C_{OUT} = 1\mu F$, $C_{BYP} = 10nF$, $T_A = 25^\circ C$ unless otherwise specified.

Output Short-Circuit Current Limit

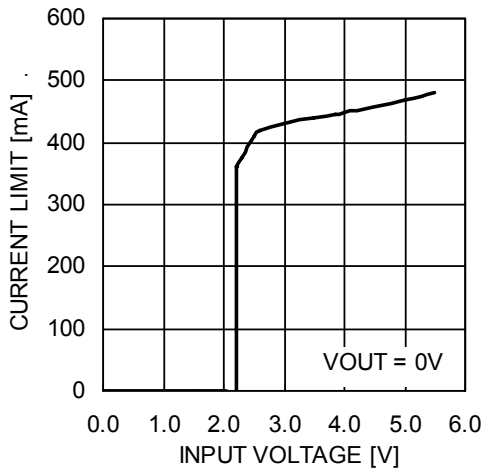

Ground Current vs. Input Voltage

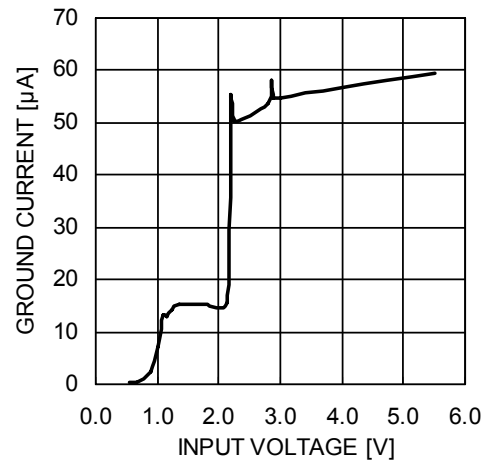

Dropout vs. Temperature (150mA Load)

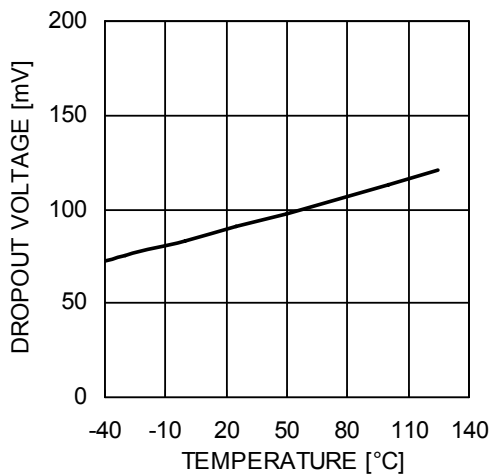

Dropout vs. Load Current

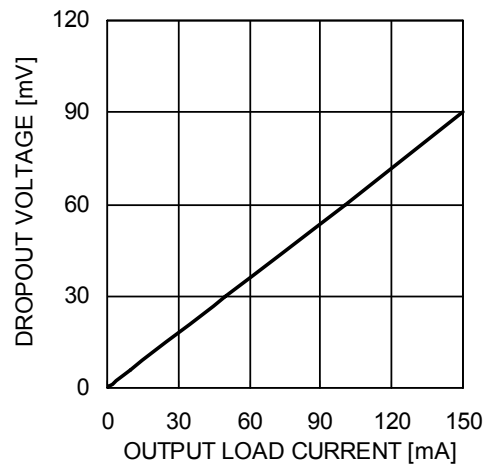

Enable Threshold vs. Input Voltage

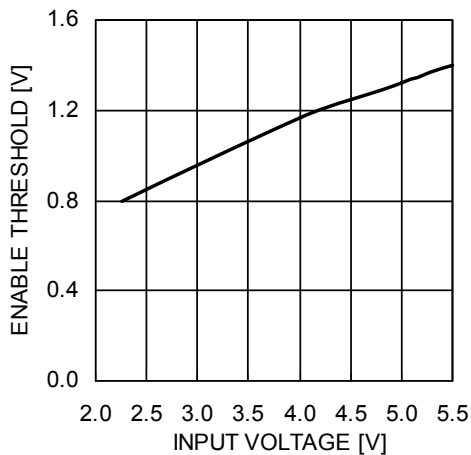

PSRR vs. Frequency (10mA Load)

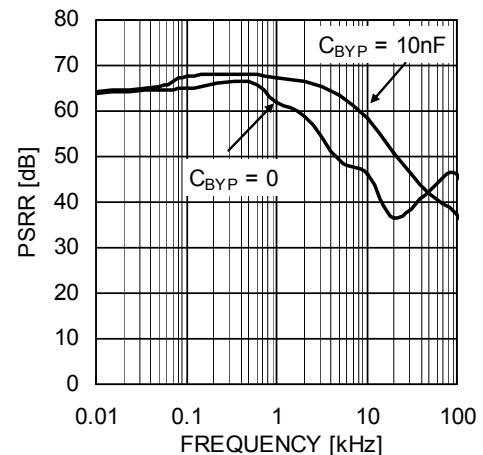

TYPICAL CHARACTERISTICS (shown for 2.85V output option)

$V_{IN} = 3.85V$, $I_{OUT} = 100\mu A$, $C_{IN} = C_{OUT} = 1\mu F$, $C_{BYP} = 10nF$, $T_A = 25^\circ C$ unless otherwise specified.

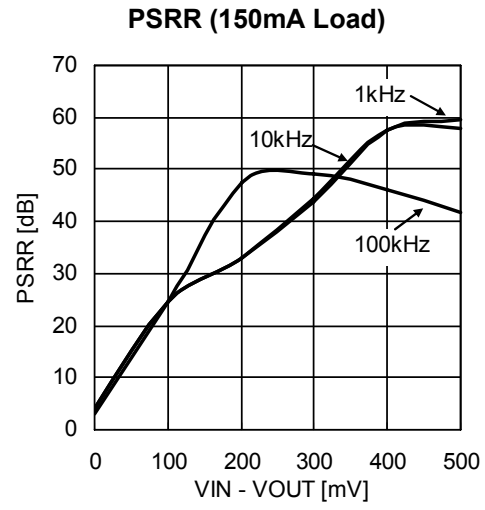
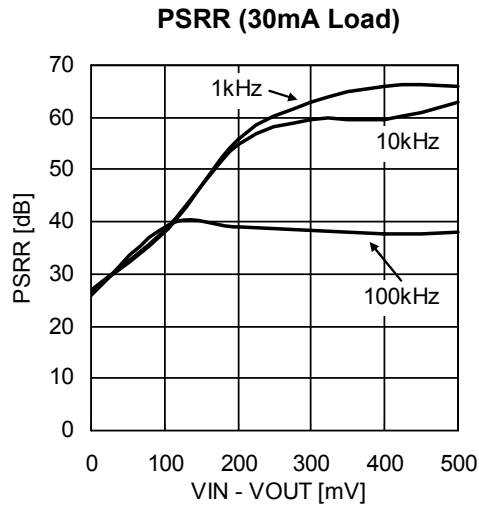

TRANSIENT CHARACTERISTICS (shown for 2.85V output option)

$V_{IN} = 3.85V$, $I_{OUT} = 100\mu A$, $C_{IN} = C_{OUT} = 1\mu F$, $C_{BYP} = 10nF$, $T_A = 25^\circ C$ unless otherwise specified.

Note: All transient characteristics are generated using the evaluation board CAT621XEVAL1.

Enable Turn-On (100 μA Load)

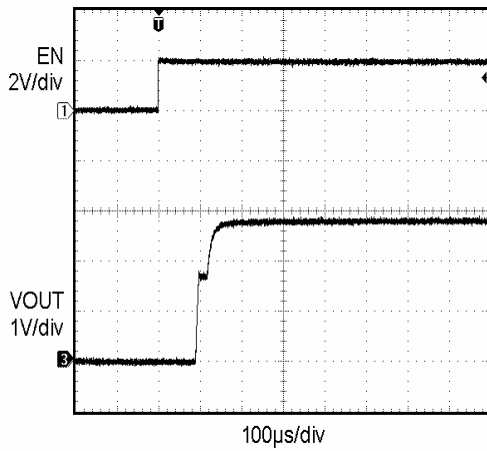

Enable Turn-Off (100 μA Load)

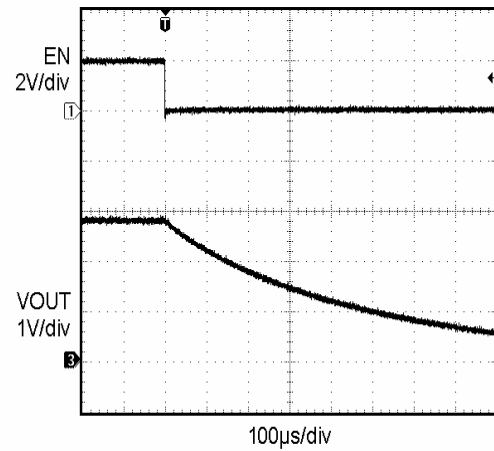

Enable Turn-On (150mA Load)

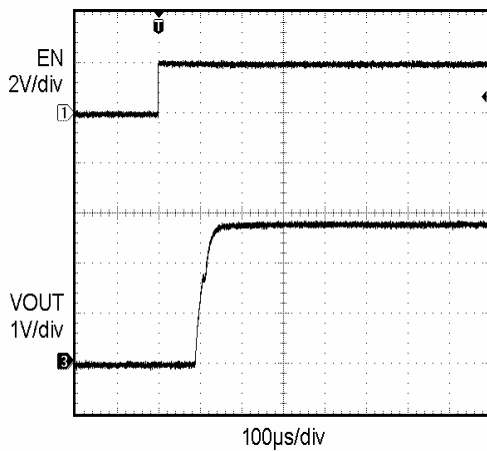

Enable Turn-Off (150mA Load)

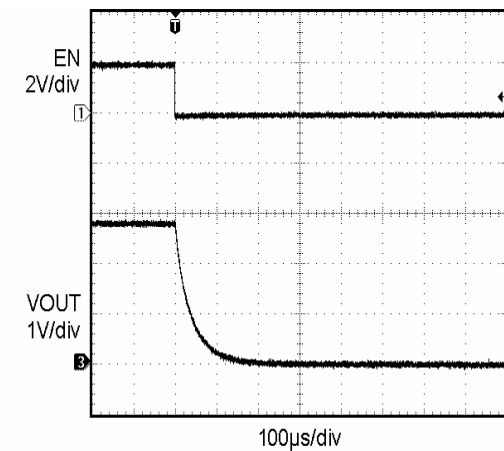

Line Transient Response (3.85V to 4.85V)

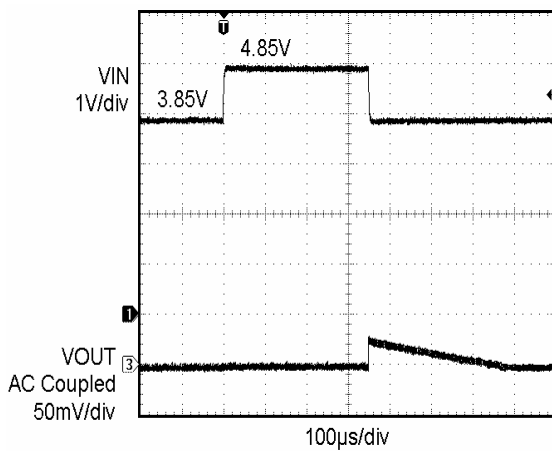

Load Transient Response (0.1mA to 150mA)

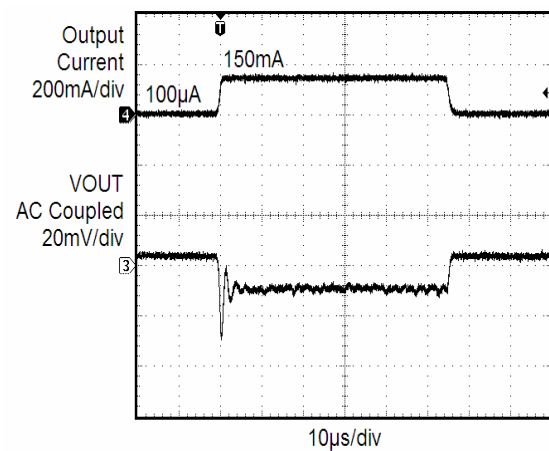

PACKAGE OUTLINES

5-LEAD TSOT-23 ⁽¹⁾⁽²⁾

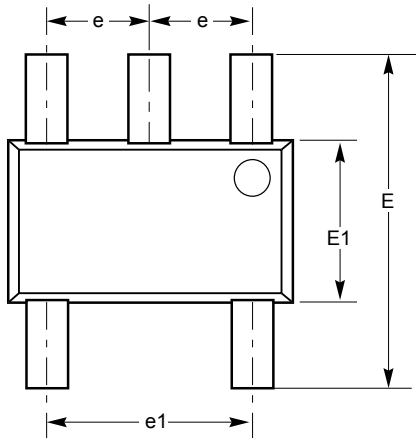

SYMBOL	MIN	NOM	MAX
A	—	—	1.00
A1	0.01	0.05	0.10
A2	0.80	0.87	0.90
b	0.30	—	0.45
c	0.12	0.15	0.20
D	2.90 BSC		
E	2.80 BSC		
E1	1.60 BSC		
e	0.95 BSC		
e1	1.90 BSC		
L	0.30	0.40	0.50
L1	0.60 REF		
L2	0.25 BSC		
θ	0°		8°

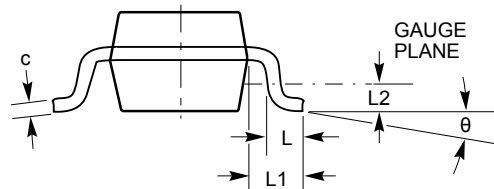
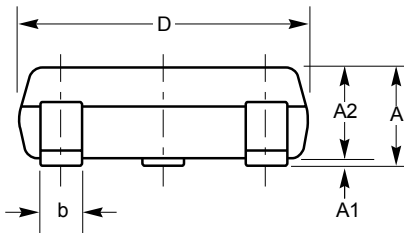

2HFor current Tape and Reel information, download the PDF file from:

Notes:

- (1) All dimensions are in millimeters, angles in degrees.
- (2) Refer JEDEC MO-193.

EXAMPLE OF ORDERING INFORMATION

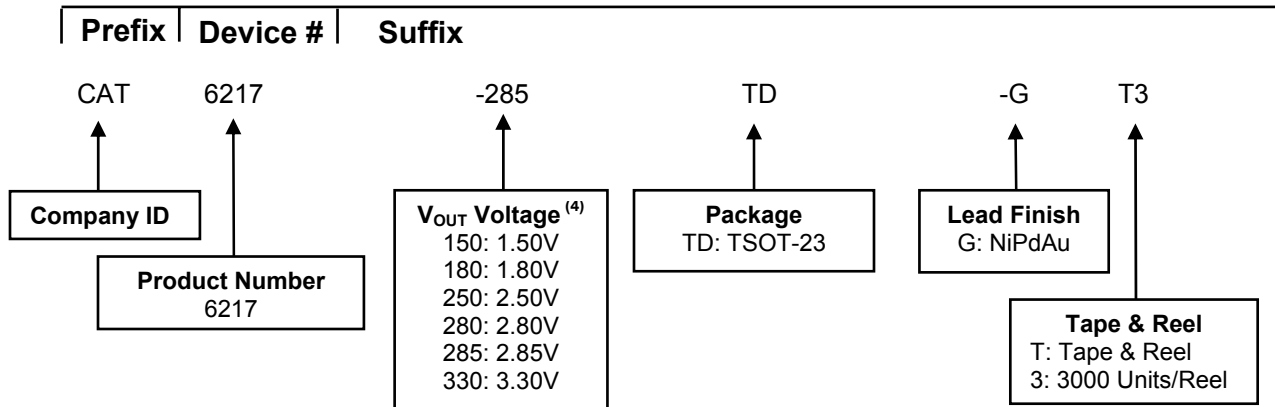

Ordering Number	V _{OUT} Voltage	Package	Quantity per Reel
CAT6217-150TD-GT3	1.50V	TSOT-23	3000
CAT6217-180TD-GT3	1.80V	TSOT-23	3000
CAT6217-250TD-GT3	2.50V	TSOT-23	3000
CAT6217-280TD-GT3	2.80V	TSOT-23	3000
CAT6217-285TD-GT3	2.85V	TSOT-23	3000
CAT6217-330TD-GT3 ⁽⁴⁾	3.30V	TSOT-23	3000

Notes:

- (1) All packages are RoHS-compliant (Lead-free, Halogen-free).
- (2) The standard finish is NiPdAu.
- (3) The device used in the above example is a CAT6217-285TD-GT3 (V_{OUT} = 2.85V, in an TSOT-23 package, NiPdAu, Tape and Reel, 3000 units).
- (4) Standard voltages are 1.50V, 1.80V, 2.50V, 2.80V, and 2.85V. For other voltage options, please contact your nearest Catalyst Semiconductor Sales office.
- (5) Top marking for CAT6217 is RT.

REVISION HISTORY

Date	Rev.	Reason
06/21/2007	A	Preliminary Revision

Copyrights, Trademarks and Patents

Trademarks and registered trademarks of Catalyst Semiconductor include each of the following:

Beyond Memory™, DPP™, EZDim™, LDD™, MiniPot™ and Quad-Mode™

Catalyst Semiconductor has been issued U.S. and foreign patents and has patent applications pending that protect its products.

CATALYST SEMICONDUCTOR MAKES NO WARRANTY, REPRESENTATION OR GUARANTEE, EXPRESS OR IMPLIED, REGARDING THE SUITABILITY OF ITS PRODUCTS FOR ANY PARTICULAR PURPOSE, NOR THAT THE USE OF ITS PRODUCTS WILL NOT INFRINGE ITS INTELLECTUAL PROPERTY RIGHTS OR THE RIGHTS OF THIRD PARTIES WITH RESPECT TO ANY PARTICULAR USE OR APPLICATION AND SPECIFICALLY DISCLAIMS ANY AND ALL LIABILITY ARISING OUT OF ANY SUCH USE OR APPLICATION, INCLUDING BUT NOT LIMITED TO, CONSEQUENTIAL OR INCIDENTAL DAMAGES.

Catalyst Semiconductor products are not designed, intended, or authorized for use as components in systems intended for surgical implant into the body, or other applications intended to support or sustain life, or for any other application in which the failure of the Catalyst Semiconductor product could create a situation where personal injury or death may occur.

Catalyst Semiconductor reserves the right to make changes to or discontinue any product or service described herein without notice. Products with data sheets labeled "Advance Information" or "Preliminary" and other products described herein may not be in production or offered for sale.

Catalyst Semiconductor advises customers to obtain the current version of the relevant product information before placing orders. Circuit diagrams illustrate typical semiconductor applications and may not be complete.



Catalyst Semiconductor, Inc.
 Corporate Headquarters
 2975 Stender Way
 Santa Clara, CA 95054
 Phone: 408.542.1000
 Fax: 408.542.1200
 1Hwww.catsemi.com

Document No: MD-4011
 Revision: A
 Issue date: 06/21/07