

CAT6217

150 mA CMOS LDO Regulator

Description

The CAT6217 is a 150 mA CMOS low dropout regulator that provides fast response time during load current and line voltage changes.

The quick-start feature allows the use of an external bypass capacitor to reduce the overall output noise without affecting the turn-on time of just 150 μ s.

With zero shutdown current and low ground current of 55 μ A typical, the CAT6217 is ideal for battery-operated devices with supply voltages from 2.3 V to 5.5 V. An internal under voltage lockout circuit disables the output at supply voltages under 2.1 V typical.

The CAT6217 offers 1% initial accuracy and low dropout voltage, 90 mV typical at 150 mA. Stable operation is provided with a 1 μ F ceramic capacitor, reducing required board space and component cost.

Other features include output short-circuit current limit and thermal protection.

The device is available in the low profile (1 mm max height) 5-lead TSOT-23 package.

Features

- Guaranteed 150 mA Output Current
- Low Dropout Voltage of 90 mV Typical at 150 mA
- Stable with 1 μ F Ceramic Output Capacitor
- External 10 nF Bypass Capacitor for Low Noise
- Quick-start Feature
- No-load Ground Current of 55 μ A Typical
- Full-load Ground Current of 80 μ A Typical
- $\pm 1.0\%$ Initial Accuracy ($V_{OUT} \geq 2.0$ V)
- $\pm 2.0\%$ Accuracy Over Temperature ($V_{OUT} \geq 2.0$ V)
- “Zero” Current Shutdown Mode
- Current Limit and Under Voltage Lockout
- Thermal Protection
- 5-lead TSOT-23 Package
- These Devices are Pb-Free, Halogen Free/BFR Free and are RoHS Compliant

Applications

- Cellular Phones
- Battery-powered Devices
- Consumer Electronics



ON Semiconductor®

<http://onsemi.com>



TSOT-23
TD SUFFIX
CASE 419AE

PIN CONNECTIONS

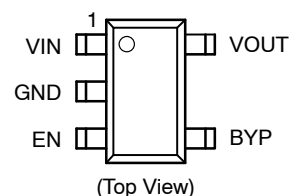

MARKING DIAGRAM

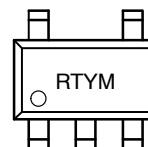

RT = CAT6217 Device Code
Y = Production Year (last digit)
M = Production Month: 1 – 9, A, B, C

PIN FUNCTION

Pin #	Name	Function
1	VIN	Supply voltage input.
2	GND	Ground reference.
3	EN	Enable input (active high); a 2.5 M Ω pull-down resistor is provided.
4	BYP	Optional bypass capacitor connection for noise reduction and PSRR enhancing.
5	VOUT	LDO Output Voltage.

ORDERING INFORMATION

See detailed ordering and shipping information in the package dimensions section on page 9 of this data sheet.

CAT6217

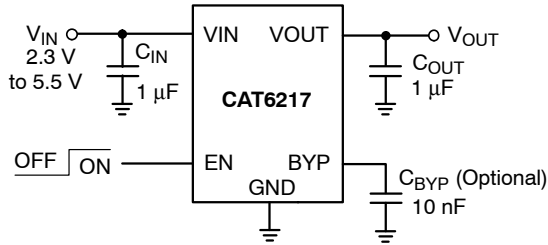

Figure 1. Typical Application Circuit

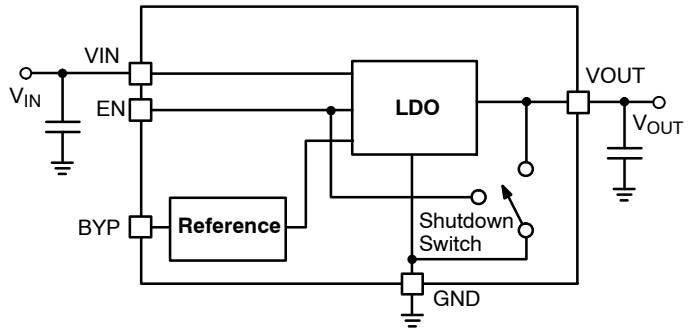

Figure 2. CAT6217 Functional Block Diagram

Pin Function

V_{IN} is the supply pin for the LDO. A small 1 μF ceramic bypass capacitor is required between the V_{IN} pin and ground near the device. When using longer connections to the power supply, C_{IN} value can be increased without limit. The operating input voltage range is from 2.3 V to 5.5 V.

EN is the enable control logic (active high) for the regulator output. It has a 2.5 MΩ pull-down resistor, which assures that if EN pin is left open, the circuit is disabled.

V_{OUT} is the LDO regulator output. A small 1 μF ceramic bypass capacitor is required between the V_{OUT} pin and ground for stability. For better transient response, its value can be increased to 4.7 μF.

The capacitor should be located near the device. ESR domain is 5 mΩ to 500 mΩ. V_{OUT} can deliver a maximum guaranteed current of 150 mA. A 250 Ω internal shutdown switch discharges the output capacitor in the no-load condition.

GND is the ground reference for the LDO. The pin must be connected to the ground plane on the PCB.

BYP is the reference bypass pin. An optional 0.01 μF capacitor can be connected between BYP pin and GND to reduce the output noise and enhance the PSRR at high frequency.

Table 1. ABSOLUTE MAXIMUM RATINGS

Parameter	Rating	Unit
V _{IN}	0 to 6.5	V
V _{EN} , V _{OUT}	-0.3 to V _{IN} + 0.3	V
Junction Temperature, T _J	+150	°C
Power Dissipation, P _D	Internally Limited (Note 1)	mW
Storage Temperature Range, T _S	-65 to +150	°C
Lead Temperature (soldering, 5 sec.)	260	°C
ESD Rating (Human Body Model)	3	kV

Stresses exceeding Maximum Ratings may damage the device. Maximum Ratings are stress ratings only. Functional operation above the Recommended Operating Conditions is not implied. Extended exposure to stresses above the Recommended Operating Conditions may affect device reliability.

Table 2. RECOMMENDED OPERATING CONDITIONS (Note 2)

Parameter	Range	Unit
V _{IN}	2.3 to 5.5	V
V _{EN}	0 to V _{IN}	V
Junction Temperature Range, T _J	-40 to +125	°C
Package Thermal Resistance (SOT23-5), θ _{JA}	235	°C/W

NOTE: Typical application circuit with external components is shown above.

- The maximum allowable power dissipation at any T_A (ambient temperature) is P_{Dmax} = (T_{Jmax} - T_A)/θ_{JA}. Exceeding the maximum allowable power dissipation will result in excessive die temperature, and the regulator will go into thermal shutdown.
- The device is not guaranteed to work outside its operating rating.

CAT6217

Table 3. ELECTRICAL OPERATING CHARACTERISTICS (Note 3)

($V_{IN} = V_{OUT} + 1.0\text{ V}$, $V_{EN} = \text{High}$, $I_{OUT} = 100\ \mu\text{A}$, $C_{IN} = C_{OUT} = 1\ \mu\text{F}$, ambient temperature of 25°C (over recommended operating conditions unless specified otherwise). **Bold numbers** apply for the entire junction temperature range.)

Symbol	Parameter	Conditions	Min	Typ	Max	Unit
$V_{OUT-ACC}$	Output Voltage Accuracy	Initial accuracy for $V_{OUT} \geq 2.0\text{ V}$ (Note 6)	-1.0		+1.0	%
			-2.0		+2.0	
TC_{OUT}	Output Voltage Temp. Coefficient			40		ppm/ $^\circ\text{C}$
V_{R-LINE}	Line Regulation	$V_{IN} = V_{OUT} + 1.0\text{ V}$ to 5.5 V	-0.2	± 0.1	+0.2	%/V
			-0.4		+0.4	
V_{R-LOAD}	Load Regulation	$I_{OUT} = 100\ \mu\text{A}$ to 150 mA		0.6	1.0	%
					1.3	
V_{DROP}	Dropout Voltage (Note 4)	$I_{OUT} = 150\text{ mA}$		90	125	mV
					150	
I_{GND}	Ground Current	$I_{OUT} = 0\ \mu\text{A}$		55	75	μA
					90	
I_{GND-SD}	Shutdown Ground Current	$V_{EN} < 0.4\text{ V}$			1	μA
					2	
PSRR	Power Supply Rejection Ratio	$f = 1\text{ kHz}$, $C_{BYP} = 10\text{ nF}$		64		dB
		$f = 20\text{ kHz}$, $C_{BYP} = 10\text{ nF}$		54		
I_{SC}	Output short circuit current limit	$V_{OUT} = 0\text{ V}$		350		mA
T_{ON}	Turn-On Time	$C_{BYP} = 10\text{ nF}$		150		μs
e_N	Output Noise Voltage (Note 5)	$BW = 10\text{ Hz}$ to 100 kHz		45		μV_{rms}
R_{OUT-SH}	Shutdown Switch Resistance			250		Ω
R_{EN}	Enable pull-down resistor			2.5		M Ω
V_{UVLO}	Under-voltage lock out (UVLO) threshold			2.1		V
ESR	C_{OUT} equivalent series resistance		5		500	m Ω

ENABLE INPUT

V_{HI}	Logic High Level	$V_{IN} = 2.3$ to 5.5 V	1.8			V
		$V_{IN} = 2.3$ to 5.5 V , 0°C to $+125^\circ\text{C}$ junction temperature	1.6			
V_{LO}	Logic Low Level	$V_{IN} = 2.3$ to 5.5 V			0.4	V
I_{EN}	Enable Input Current	$V_{EN} = 0.4\text{ V}$		0.15	1	μA
		$V_{EN} = V_{IN}$		1.5	4	

THERMAL PROTECTION

T_{SD}	Thermal Shutdown			160		$^\circ\text{C}$
T_{HYS}	Thermal Hysteresis			10		$^\circ\text{C}$

3. Specification for 2.80 V output version unless specified otherwise.
4. Dropout voltage is defined as the input-to-output differential at which the output voltage drops 2% below its nominal value. During test, the input voltage stays always above the minimum 2.3 V.
5. Specification for 1.8 V output version.
6. For $V_{OUT} < 2.0\text{ V}$, the initial accuracy is $\pm 2\%$ and across temperature $\pm 3\%$.

CAT6217

TYPICAL CHARACTERISTICS (shown for 2.80 V output option)

($V_{IN} = 3.85\text{ V}$, $I_{OUT} = 100\ \mu\text{A}$, $C_{IN} = C_{OUT} = 1\ \mu\text{F}$, $C_{BYP} = 10\ \text{nF}$, $T_A = 25^\circ\text{C}$ unless otherwise specified.)

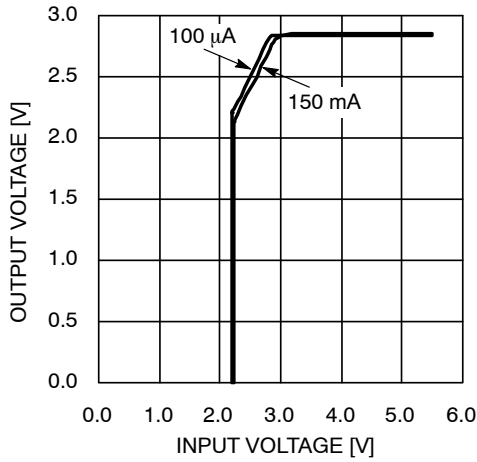

Figure 3. Dropout Characteristics

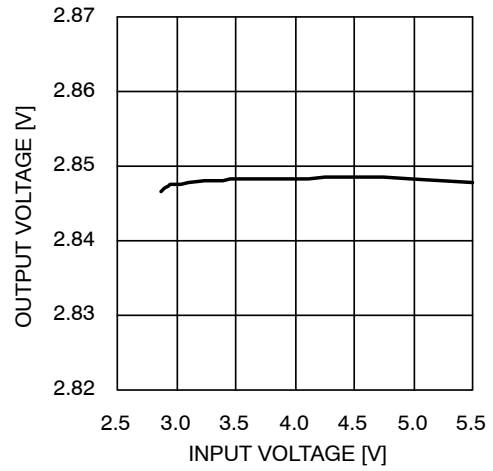

Figure 4. Line Regulation

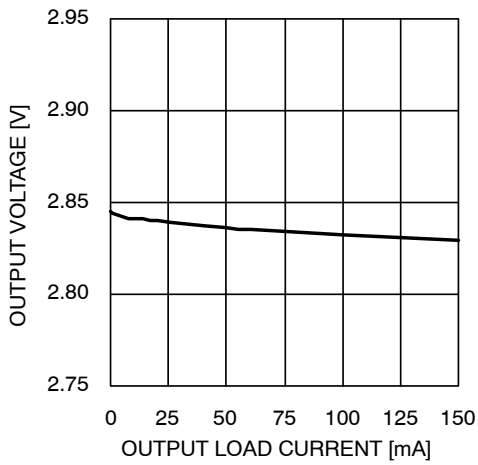

Figure 5. Load Regulation

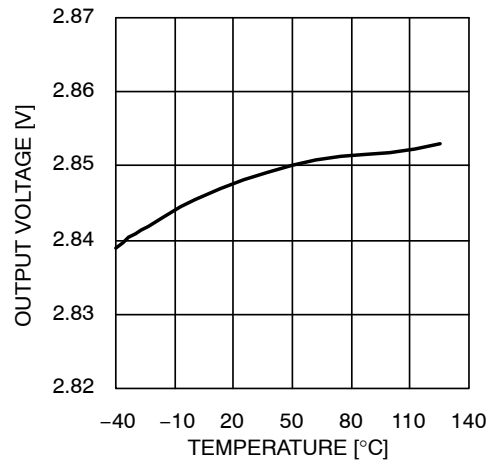

Figure 6. Output Voltage vs. Temperature

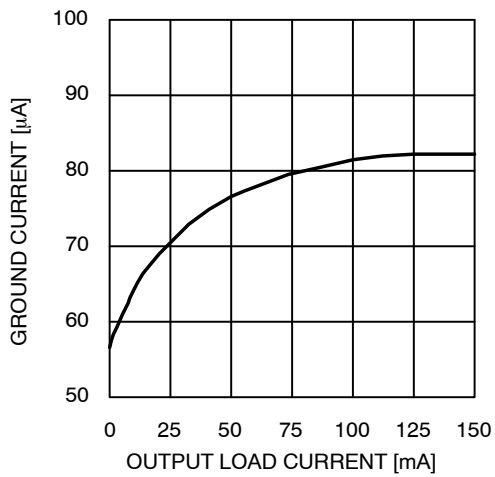

Figure 7. Ground Current vs. Load Current

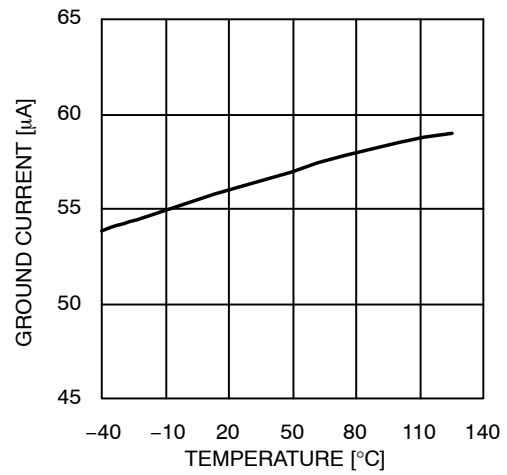

Figure 8. Ground Current vs. Temperature

CAT6217

TYPICAL CHARACTERISTICS (shown for 2.80 V output option)

($V_{IN} = 3.85\text{ V}$, $I_{OUT} = 100\ \mu\text{A}$, $C_{IN} = C_{OUT} = 1\ \mu\text{F}$, $C_{BYP} = 10\ \text{nF}$, $T_A = 25^\circ\text{C}$ unless otherwise specified.)

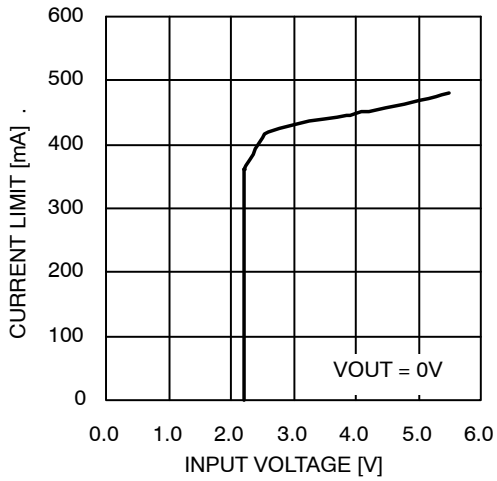

Figure 9. Output Short-circuit Current Limit

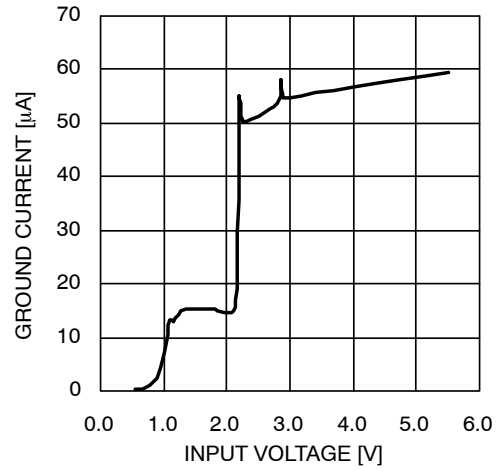

Figure 10. Ground Current vs. Input Voltage

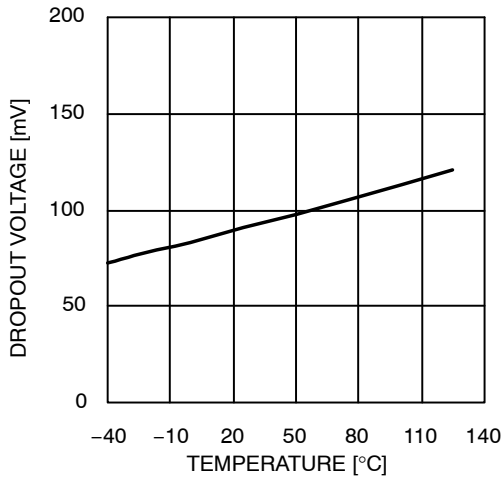

Figure 11. Dropout vs. Temperature (150 mA Load)

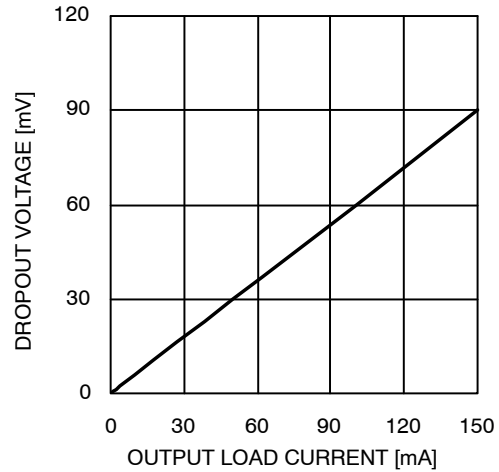

Figure 12. Dropout vs. Load Current

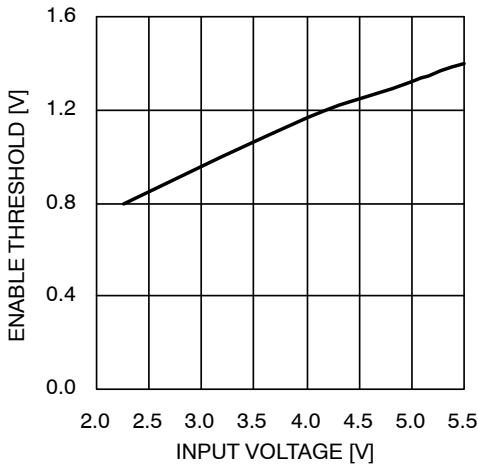

Figure 13. Enable Threshold vs. Input Voltage

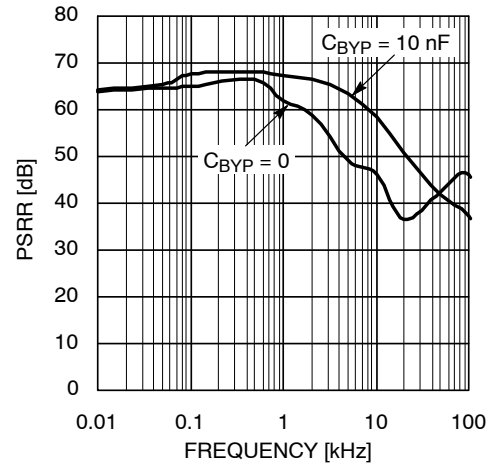

Figure 14. PSRR vs. Frequency (10 mA Load)

CAT6217

TYPICAL CHARACTERISTICS (shown for 2.80 V output option)

($V_{IN} = 3.85\text{ V}$, $I_{OUT} = 100\ \mu\text{A}$, $C_{IN} = C_{OUT} = 1\ \mu\text{F}$, $C_{BYP} = 10\ \text{nF}$, $T_A = 25^\circ\text{C}$ unless otherwise specified.)

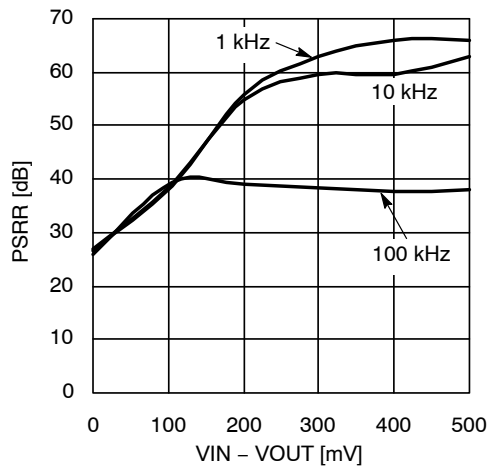

Figure 15. PSRR (30 mA Load)

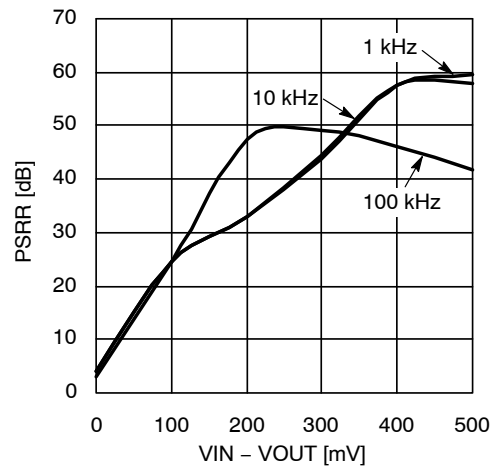

Figure 16. PSRR (150 mA Load)

TRANSIENT CHARACTERISTICS (shown for 2.80 V output option)

($V_{IN} = 3.85\text{ V}$, $I_{OUT} = 100\ \mu\text{A}$, $C_{IN} = C_{OUT} = 1\ \mu\text{F}$, $C_{BYP} = 10\ \text{nF}$, $T_A = 25^\circ\text{C}$ unless otherwise specified.)

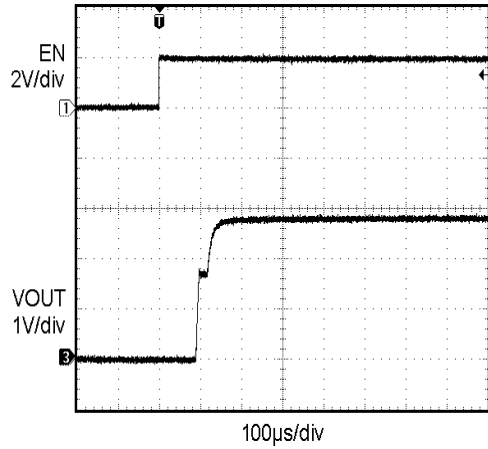

Figure 17. Enable Turn-on (100 μA Load)

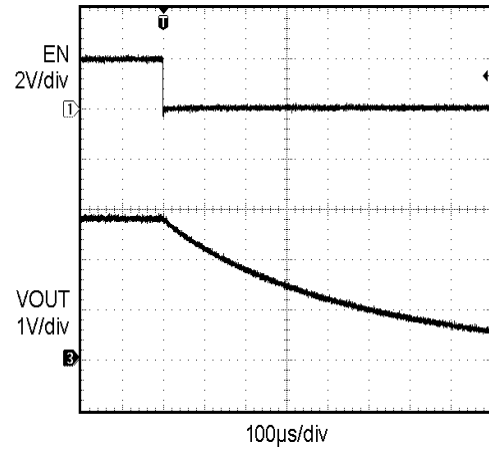

Figure 18. Enable Turn-off (100 μA Load)

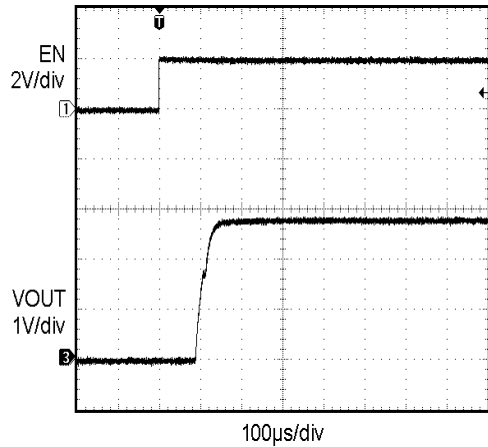

Figure 19. Enable Turn-on (150 mA Load)

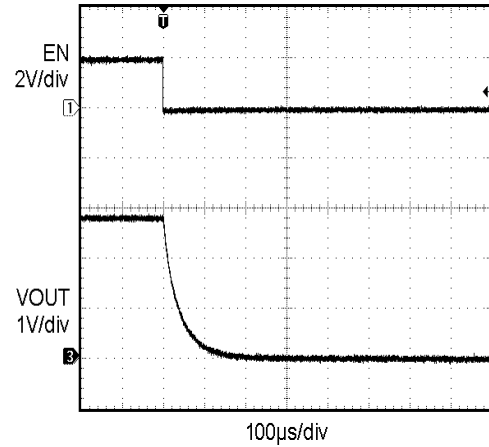

Figure 20. Enable Turn-off (150 mA Load)

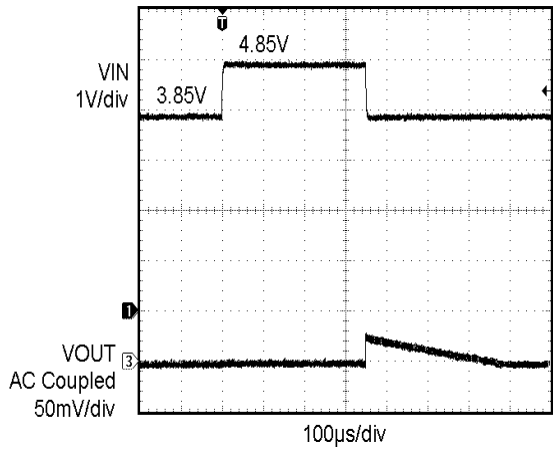

Figure 21. Line Transient Response (3.85 V to 4.85 V)

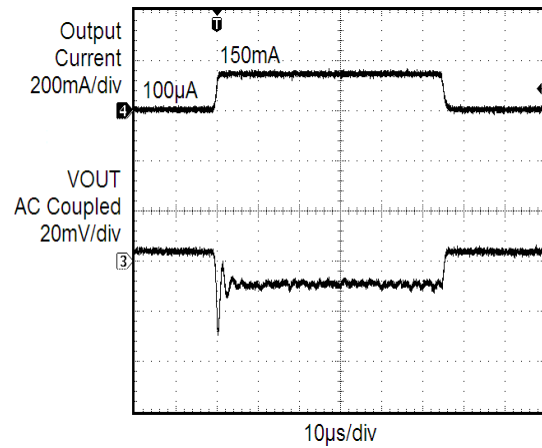
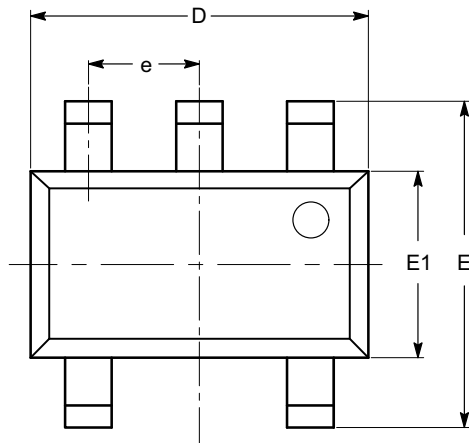

Figure 22. Load Transient Response (0.1 mA to 150 mA)

Note: All transient characteristics are generated using the evaluation board CAT621XEVAL1.

TSOT-23, 5 LEAD
CASE 419AE-01
ISSUE O

DATE 19 DEC 2008



TOP VIEW

SYMBOL	MIN	NOM	MAX
A			1.00
A1	0.01	0.05	0.10
A2	0.80	0.87	0.90
b	0.30		0.45
c	0.12	0.15	0.20
D	2.90 BSC		
E	2.80 BSC		
E1	1.60 BSC		
e	0.95 TYP		
L	0.30	0.40	0.50
L1	0.60 REF		
L2	0.25 BSC		
θ	0°		8°

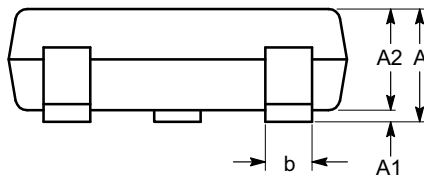

SIDE VIEW

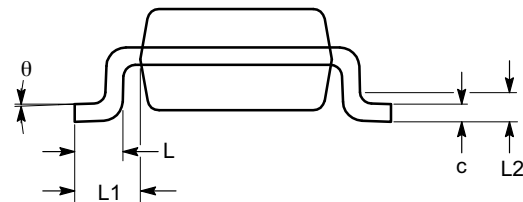

END VIEW

Notes:

- (1) All dimensions are in millimeters. Angles in degrees.
- (2) Complies with JEDEC MO-193.

DOCUMENT NUMBER:	98AON34392E	Electronic versions are uncontrolled except when accessed directly from the Document Repository. Printed versions are uncontrolled except when stamped "CONTROLLED COPY" in red.
DESCRIPTION:	TSOT-23, 5 LEAD	PAGE 1 OF 1

ON Semiconductor and are trademarks of Semiconductor Components Industries, LLC dba ON Semiconductor or its subsidiaries in the United States and/or other countries. ON Semiconductor reserves the right to make changes without further notice to any products herein. ON Semiconductor makes no warranty, representation or guarantee regarding the suitability of its products for any particular purpose, nor does ON Semiconductor assume any liability arising out of the application or use of any product or circuit, and specifically disclaims any and all liability, including without limitation special, consequential or incidental damages. ON Semiconductor does not convey any license under its patent rights nor the rights of others.

onsemi, **Onsemi**, and other names, marks, and brands are registered and/or common law trademarks of Semiconductor Components Industries, LLC dba "**onsemi**" or its affiliates and/or subsidiaries in the United States and/or other countries. **onsemi** owns the rights to a number of patents, trademarks, copyrights, trade secrets, and other intellectual property. A listing of **onsemi**'s product/patent coverage may be accessed at www.onsemi.com/site/pdf/Patent-Marking.pdf. **onsemi** reserves the right to make changes at any time to any products or information herein, without notice. The information herein is provided "as-is" and **onsemi** makes no warranty, representation or guarantee regarding the accuracy of the information, product features, availability, functionality, or suitability of its products for any particular purpose, nor does **onsemi** assume any liability arising out of the application or use of any product or circuit, and specifically disclaims any and all liability, including without limitation special, consequential or incidental damages. Buyer is responsible for its products and applications using **onsemi** products, including compliance with all laws, regulations and safety requirements or standards, regardless of any support or applications information provided by **onsemi**. "Typical" parameters which may be provided in **onsemi** data sheets and/or specifications can and do vary in different applications and actual performance may vary over time. All operating parameters, including "Typicals" must be validated for each customer application by customer's technical experts. **onsemi** does not convey any license under any of its intellectual property rights nor the rights of others. **onsemi** products are not designed, intended, or authorized for use as a critical component in life support systems or any FDA Class 3 medical devices or medical devices with a same or similar classification in a foreign jurisdiction or any devices intended for implantation in the human body. Should Buyer purchase or use **onsemi** products for any such unintended or unauthorized application, Buyer shall indemnify and hold **onsemi** and its officers, employees, subsidiaries, affiliates, and distributors harmless against all claims, costs, damages, and expenses, and reasonable attorney fees arising out of, directly or indirectly, any claim of personal injury or death associated with such unintended or unauthorized use, even if such claim alleges that **onsemi** was negligent regarding the design or manufacture of the part. **onsemi** is an Equal Opportunity/Affirmative Action Employer. This literature is subject to all applicable copyright laws and is not for resale in any manner.

PUBLICATION ORDERING INFORMATION

LITERATURE FULFILLMENT:

Email Requests to: orderlit@onsemi.com

onsemi Website: www.onsemi.com

TECHNICAL SUPPORT

North American Technical Support:

Voice Mail: 1 800-282-9855 Toll Free USA/Canada

Phone: 011 421 33 790 2910

Europe, Middle East and Africa Technical Support:

Phone: 00421 33 790 2910

For additional information, please contact your local Sales Representative