

CAT6219

LDO Regulator - CMOS

500 mA

Description

The CAT6219 is a 500 mA CMOS low dropout regulator that provides fast response time during load current and line voltage changes.

The quick-start feature allows the use of an external bypass capacitor to reduce the overall output noise without affecting the turn-on time of just 150 μ s.

With zero shutdown current and low ground current of 55 μ A typical, the CAT6219 is ideal for battery-operated devices with supply voltages from 2.3 V to 5.5 V. An internal under voltage lockout circuit disables the output at supply voltages under 2.15 V typical.

The CAT6219 offers 1% initial accuracy and low dropout voltage, 300 mV typical at 500 mA. Stable operation is provided with a small value ceramic capacitor, reducing required board space and component cost.

Other features include current limit and thermal protection.

The LDO is available in fixed and adjustable output in the low profile (1 mm max height) 5-lead TSOT23, 6-pad 1.5 mm x 1.5 mm WDFN and in the 6-pad 2 mm x 2 mm TDFN packages.

Features

- Guaranteed 500 mA Peak Output Current
- Low Dropout Voltage of 300 mV Typical at 500 mA
- Stable with Ceramic Output Capacitor
- External 10 nF Bypass Capacitor for Low Noise
- Quick-start Feature
- Under Voltage Lockout
- No-load Ground Current of 55 μ A Typical
- Full-load Ground Current of 85 μ A Typical
- $\pm 1.0\%$ Initial Accuracy ($V_{OUT} \geq 2.0$ V)
- $\pm 2.0\%$ Accuracy Over Temperature ($V_{OUT} \geq 2.0$ V)
- “Zero” Current Shutdown Mode
- Fold-back Current Limit
- Thermal Protection
- 5-lead TSOT-23, 6-pad WDFN and TDFN Packages
- These Devices are Pb-Free, Halogen Free/BFR Free and are RoHS Compliant

Applications

- Cellular Phones
- Battery-powered Devices
- Consumer Electronics



ON Semiconductor®

<http://onsemi.com>

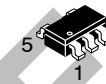

TSOT-23
TD SUFFIX
CASE 419AE



WDFN-6
MV2 SUFFIX
CASE 511BJ



TDFN-6
VP5 SUFFIX
CASE 511AH

PIN CONNECTIONS

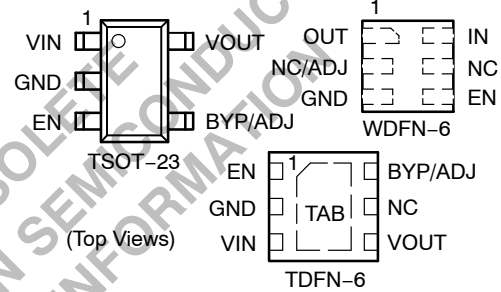

MARKING DIAGRAMS

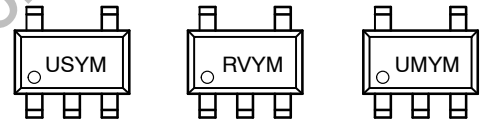

US = CAT6219-125, CAT6219-250, CAT6219-300 Device Code
RV = CAT6219-180, CAT6219-280, CAT6219-285, CAT6219-330 Device Code
UM = CAT6219-ADJ Device Code
Y = Production Year (last digit)
M = Production Month: 1 - 9, A, B, C

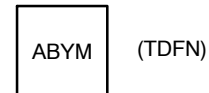

AB = CAT6219180, CAT6219VP5 Device Code
Y = Production Year (last digit)
M = Production Month: 1 - 9, A, B, C

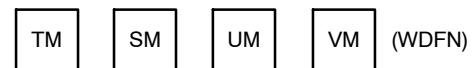

T = CAT6219-285MV2 Device Code
S = CAT6219-280MV2 Device Code
U = CAT6219-330MV2 Device Code
V = CAT6219-ADJMV2 Device Code
M = Date Code

ORDERING INFORMATION

See detailed ordering and shipping information in the package dimensions section on page 11 of this data sheet.

CAT6219

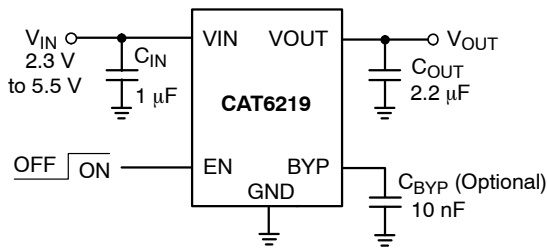

Figure 1. Typical Application Circuit

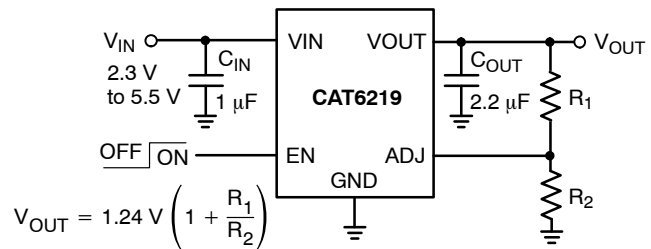

Figure 2. Adjustable Output LDO

Table 1. PIN DESCRIPTIONS

Name	Function
VIN	Supply voltage input.
GND	Ground reference.
EN	Enable input (active high); a 2.5 MΩ pull-down resistor is provided.
BYP	Optional bypass capacitor connection for noise reduction and PSRR enhancing.
ADJ	Adjustable input. Feedback pin connected to resistor divider.
VOUT	LDO Output Voltage.
TAB	To be connected to the ground plane on PCB

Pin Function

VIN is the supply pin for the LDO. A small 1 μF ceramic bypass capacitor is required between the VIN pin and ground near the device. When using longer connections to the power supply, CIN value can be increased without limit. The operating input voltage range is from 2.3 V to 5.5 V.

Table 2. ABSOLUTE MAXIMUM RATINGS

Parameter	Rating	Unit
VIN	0 to 6.5	V
VEN, VOUT	-0.3 to VIN + 0.3	V
Junction Temperature, TJ	+150	°C
Power Dissipation, PD	Internally Limited (Note 1)	mW
Storage Temperature Range, TS	-65 to +150	°C
Lead Temperature (soldering, 5 sec.)	260	°C
ESD Rating (Human Body Model)	3	kV

Stresses exceeding Maximum Ratings may damage the device. Maximum Ratings are stress ratings only. Functional operation above the Recommended Operating Conditions is not implied. Extended exposure to stresses above the Recommended Operating Conditions may affect device reliability.

Table 3. RECOMMENDED OPERATING CONDITIONS (Note 2)

Parameter	Range	Unit
VIN	2.3 to 5.5	V
VEN	0 to VIN	V
Junction Temperature Range, TJ	-40 to +125	°C
Package Thermal Resistance, θJA	SOT23-5 235 TDFN-6 206	°C/W

NOTE: Typical application circuit with external components is shown above.

- The maximum allowable power dissipation at any TA (ambient temperature) is $P_{Dmax} = (T_{Jmax} - T_A)/\theta_{JA}$. Exceeding the maximum allowable power dissipation will result in excessive die temperature, and the regulator will go into thermal shutdown.
- The device is not guaranteed to work outside its operating rating.

CAT6219

Table 4. ELECTRICAL OPERATING CHARACTERISTICS (Note 3)

($V_{IN} = V_{OUT} + 1.0$ V, $V_{EN} = \text{High}$, $I_{OUT} = 100$ μA , $C_{IN} = 1$ μF , $C_{OUT} = 2.2$ μF , ambient temperature of 25°C (over recommended operating conditions unless specified otherwise). **Bold numbers** apply for the entire junction temperature range.)

Symbol	Parameter	Conditions	Min	Typ	Max	Unit
$V_{OUT-ACC}$	Output Voltage Accuracy	Initial accuracy for $V_{OUT} \geq 2.0$ V (Note 6)	-1.0		+1.0	%
			-2.0		+2.0	
TC_{OUT}	Output Voltage Temp. Coefficient			40		ppm/°C
V_{R-LINE}	Line Regulation	$V_{IN} = V_{OUT} + 1.0$ V to 5.5 V	-0.2	± 0.1	+0.2	%/V
			-0.4		+0.4	
V_{R-LOAD}	Load Regulation	$I_{OUT} = 100$ μA to 500 mA		1	1.5	%
					2	
V_{DROP}	Dropout Voltage (Note 4)	$I_{OUT} = 500$ mA		300	400	mV
					500	
I_{GND}	Ground Current	$I_{OUT} = 0$ μA		55	75	μA
		$I_{OUT} = 500$ mA		85	90	
I_{GND-SD}	Shutdown Ground Current	$V_{EN} < 0.4$ V			1	μA
					2	
PSRR	Power Supply Rejection Ratio	$f = 1$ kHz, $C_{BYP} = 10$ nF		64		dB
		$f = 20$ kHz, $C_{BYP} = 10$ nF		54		
I_{SC}	Output short circuit current limit	$V_{OUT} = 0$ V		200		mA
T_{ON}	Turn-On Time	$C_{BYP} = 10$ nF		150		μs
e_N	Output Noise Voltage (Note 5)	$BW = 10$ Hz to 100 kHz		45		μV_{rms}
R_{OUT-SH}	Shutdown Switch Resistance			250		Ω
R_{EN}	Enable pull-down resistor			2.5		M Ω
V_{UVLO}	Under voltage lockout threshold			2.15		V
ESR	C_{OUT} equivalent series resistance		5		500	m Ω
V_{ADJ}	Adjustable input voltage	$I_{OUT} = 100$ μA	1.2	1.24	1.27	V

ENABLE INPUT

V_{HI}	Logic High Level	$V_{IN} = 2.3$ to 5.5 V	1.8			V
		$V_{IN} = 2.3$ to 5.5 V, 0°C to +125°C junction temperature	1.6			
V_{LO}	Logic Low Level	$V_{IN} = 2.3$ to 5.5 V			0.4	V
I_{EN}	Enable Input Current	$V_{EN} = 0.4$ V		0.15	1	μA
		$V_{EN} = V_{IN}$		1.5	4	

THERMAL PROTECTION

T_{SD}	Thermal Shutdown			160		°C
T_{HYS}	Thermal Hysteresis			10		°C

3. Specification for 2.80 V output version unless specified otherwise.
4. Dropout voltage is defined as the input-to-output differential at which the output voltage drops 2% below its nominal value. During test, the input voltage stays always above the minimum 2.3 V.
5. Specification for 1.8 V output version.
6. For $V_{OUT} < 2.0$ V, the initial accuracy is $\pm 2\%$ and across temperature $\pm 3\%$.

CAT6219

TYPICAL CHARACTERISTICS (shown for 2.80 V output option)

($V_{IN} = 3.85\text{ V}$, $I_{OUT} = 100\ \mu\text{A}$, $C_{IN} = 1\ \mu\text{F}$, $C_{OUT} = 2.2\ \mu\text{F}$, $C_{BYP} = 10\ \text{nF}$, $T_A = 25^\circ\text{C}$ unless otherwise specified.)

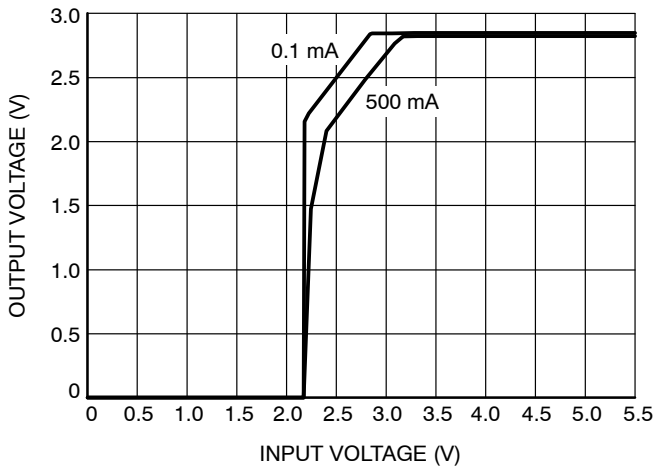

Figure 3. Dropout Characteristics

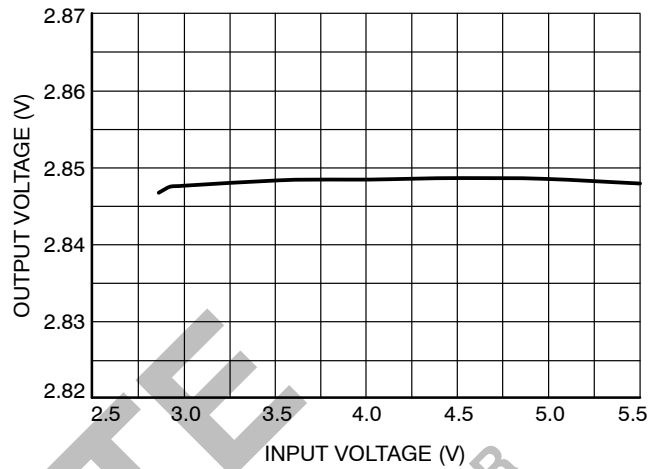

Figure 4. Line Regulation

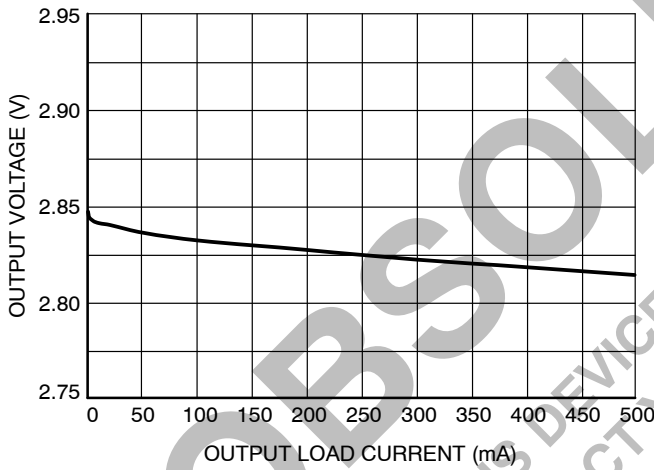

Figure 5. Load Regulation

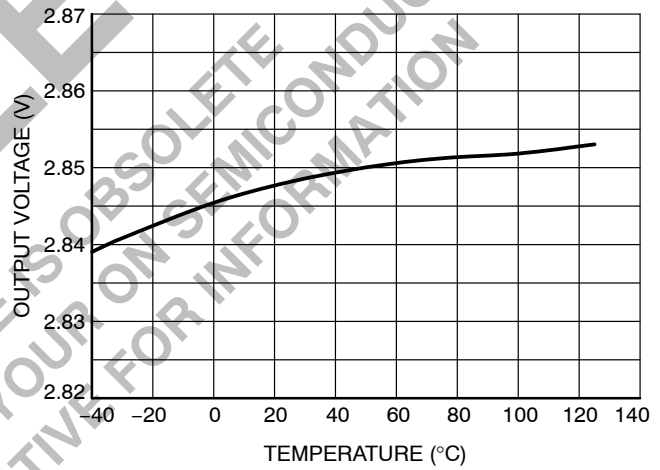

Figure 6. Output Voltage vs. Temperature

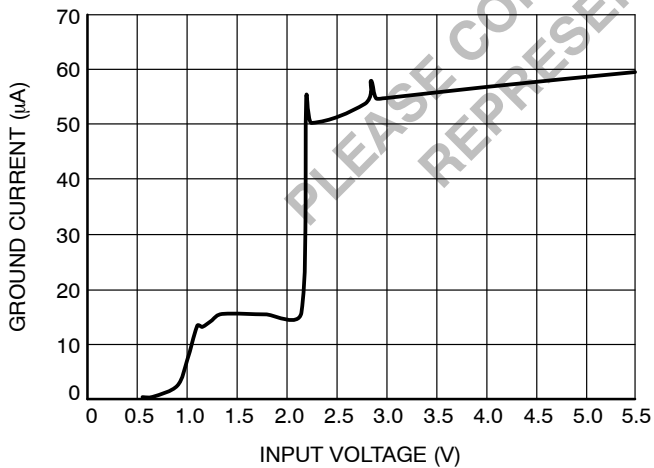

Figure 7. Ground Current vs. Input Voltage

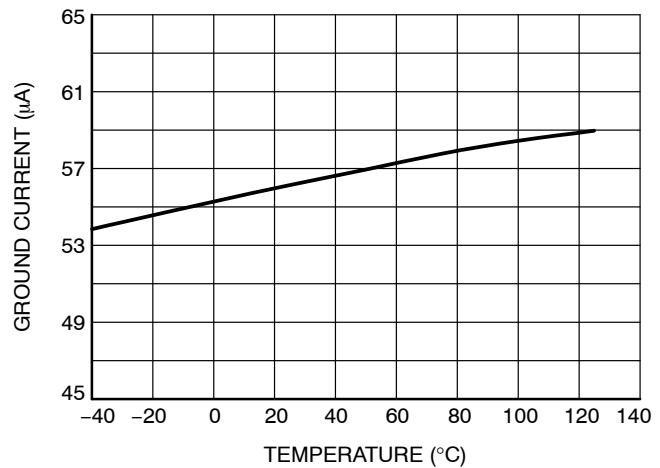

Figure 8. Ground Current vs. Temperature

CAT6219

TYPICAL CHARACTERISTICS (shown for 2.80 V output option)

($V_{IN} = 3.85\text{ V}$, $I_{OUT} = 100\ \mu\text{A}$, $C_{IN} = 1\ \mu\text{F}$, $C_{OUT} = 2.2\ \mu\text{F}$, $C_{BYP} = 10\ \text{nF}$, $T_A = 25^\circ\text{C}$ unless otherwise specified.)

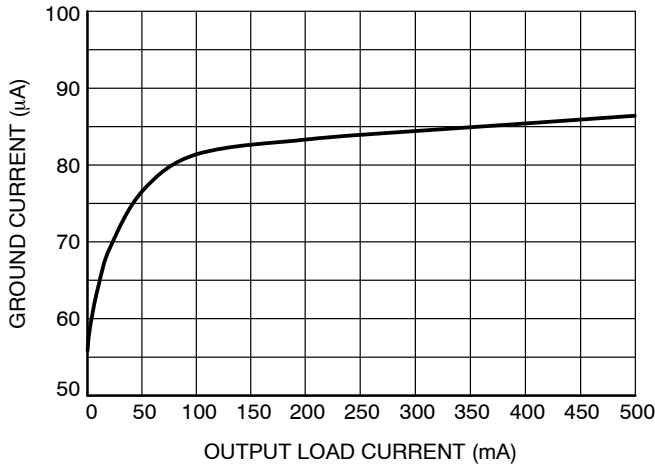

Figure 9. Ground Current vs. Load Current

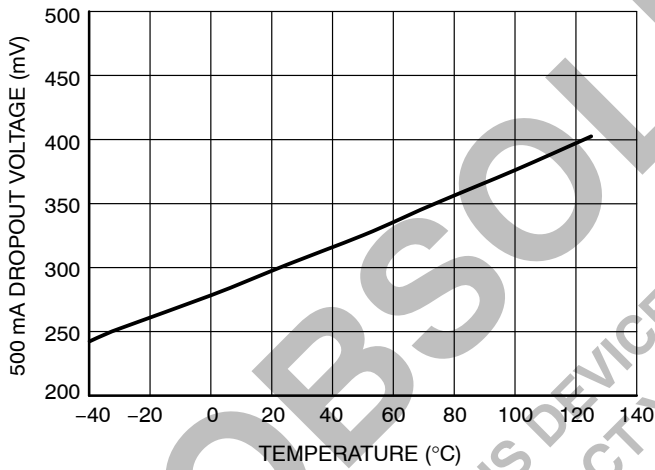

Figure 10. Dropout vs. Temperature (500 mA Load)

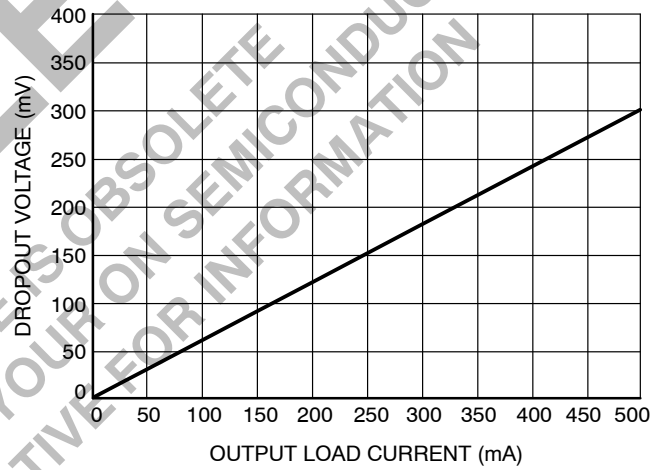

Figure 11. Dropout vs. Load Current

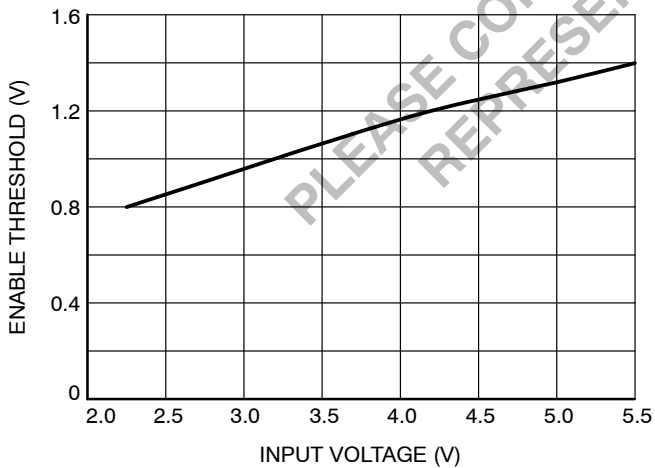

Figure 12. Enable Threshold vs. Input Voltage

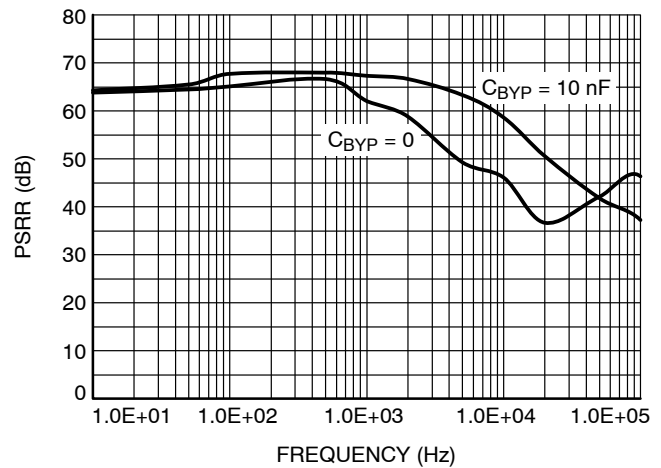

Figure 13. PSRR vs. Frequency (10 mA Load)

TRANSIENT CHARACTERISTICS (shown for 2.80 V output option)

($V_{IN} = 3.85\text{ V}$, $I_{OUT} = 100\ \mu\text{A}$, $C_{IN} = 1\ \mu\text{F}$, $C_{OUT} = 2.2\ \mu\text{F}$, $C_{BYP} = 10\ \text{nF}$, $T_A = 25^\circ\text{C}$ unless otherwise specified.)

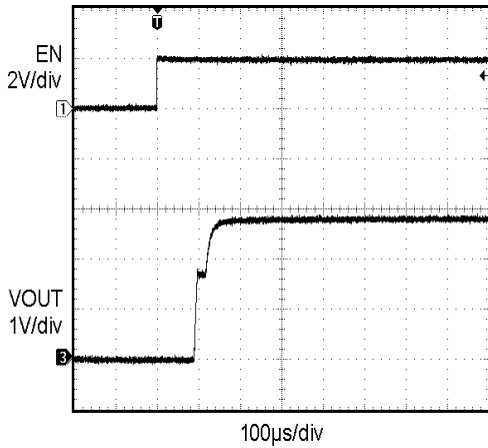

Figure 14. Enable Turn-on (100 μA Load)

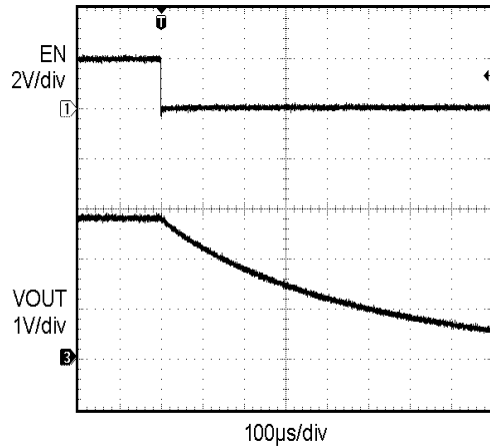

Figure 15. Enable Turn-off (100 μA Load)

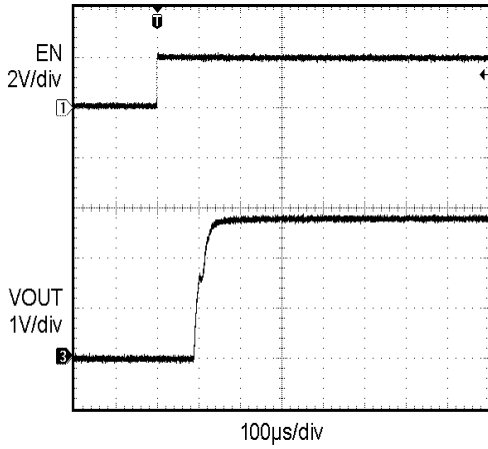

Figure 16. Enable Turn-on (500 mA Load)

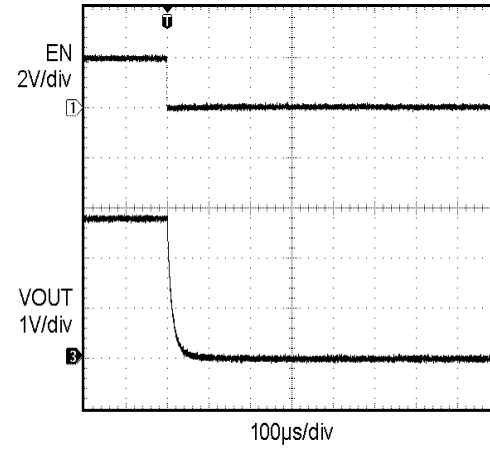

Figure 17. Enable Turn-off (500 mA Load)

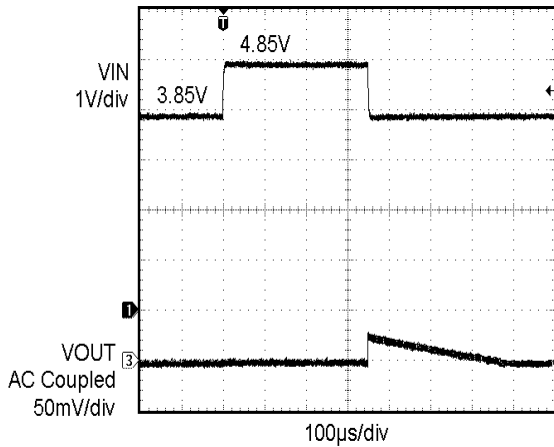

Figure 18. Line Transient Response (3.85 V to 4.85 V)

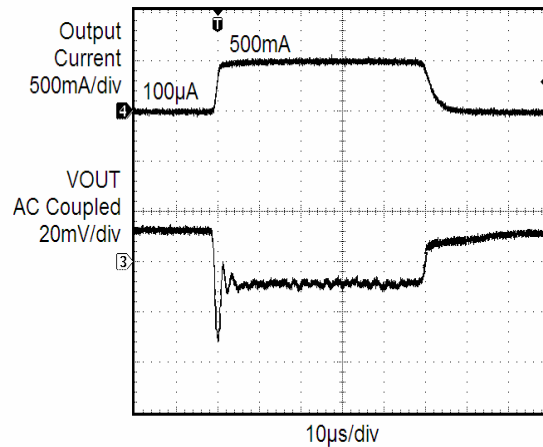

Figure 19. Load Transient Response (0.1 mA to 500 mA)

CAT6219

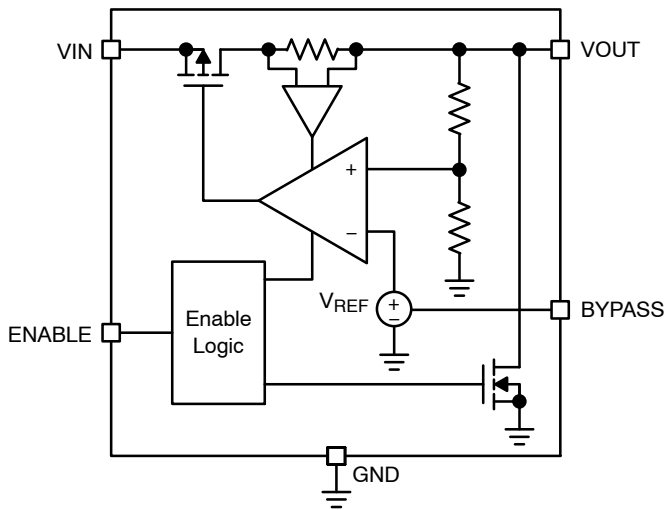

Figure 20. Block Diagram – Fixed Voltage

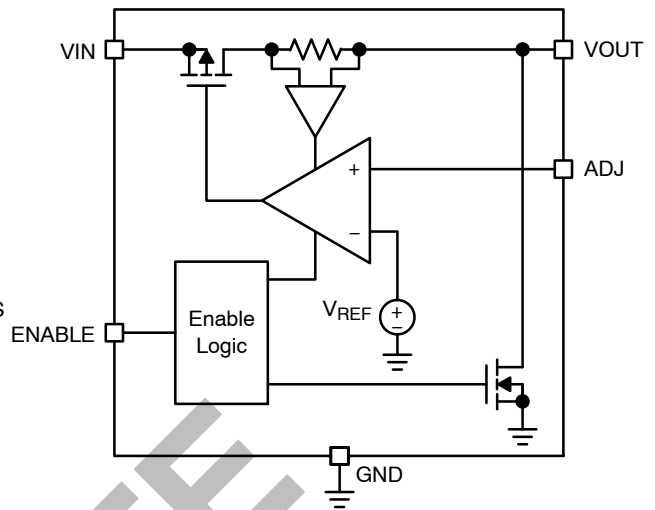

Figure 21. Block Diagram – Adjustable Voltage

OBSOLETE
THIS DEVICE IS OBSOLETE
PLEASE CONTACT YOUR ON SEMICONDUCTOR
REPRESENTATIVE FOR INFORMATION

CAT6219

PACKAGE DIMENSIONS

TSOT-23, 5 LEAD
CASE 419AE-01
ISSUE O

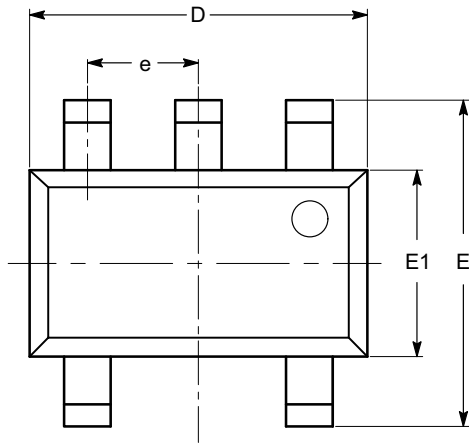

TOP VIEW

SYMBOL	MIN	NOM	MAX
A			1.00
A1	0.01	0.05	0.10
A2	0.80	0.87	0.90
b	0.30		0.45
c	0.12	0.15	0.20
D	2.90 BSC		
E	2.80 BSC		
E1	1.60 BSC		
e	0.95 TYP		
L	0.30	0.40	0.50
L1	0.60 REF		
L2	0.25 BSC		
θ	0°		8°

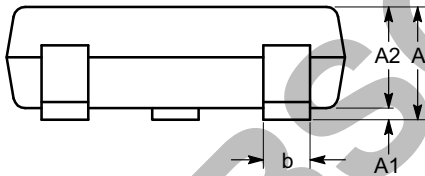

SIDE VIEW

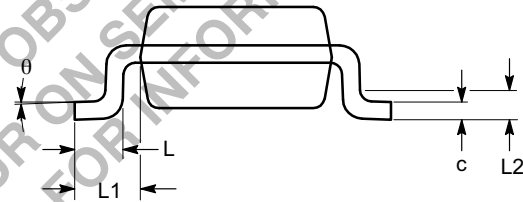

END VIEW

Notes:

- (1) All dimensions are in millimeters. Angles in degrees.
- (2) Complies with JEDEC MO-193.

CAT6219

PACKAGE DIMENSIONS

TDFN6, 2x2
CASE 511AH-01
ISSUE A

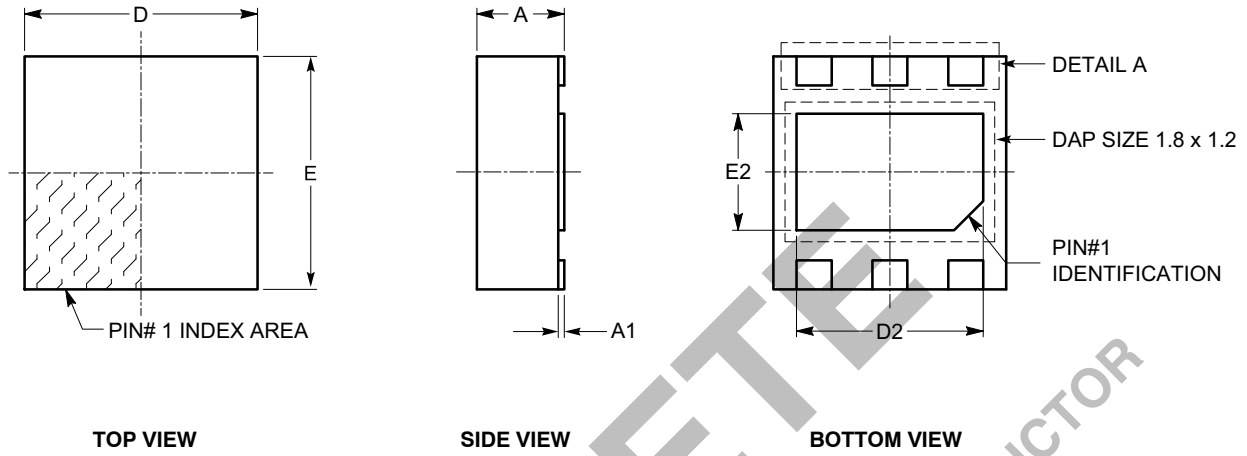

SYMBOL	MIN	NOM	MAX
A	0.70	0.75	0.80
A1	0.00	0.02	0.05
A3	0.20 REF		
b	0.25	0.30	0.35
D	1.90	2.00	2.10
D2	1.50	1.60	1.70
E	1.90	2.00	2.10
E2	0.90	1.00	1.10
e	0.65 TYP		
L	0.15	0.25	0.35

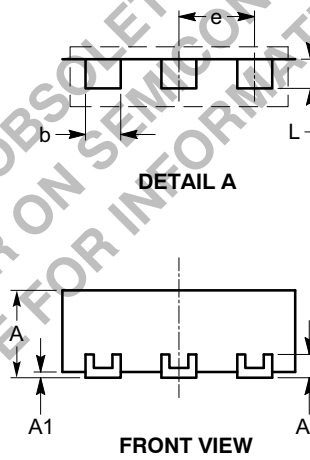

Notes:

- (1) All dimensions are in millimeters.
- (2) Complies with JEDEC standard MO-229.

CAT6219

PACKAGE DIMENSIONS

WDFN6 1.5x1.5, 0.5P
CASE 511BJ-01
ISSUE B

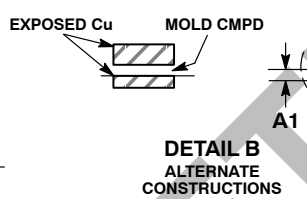
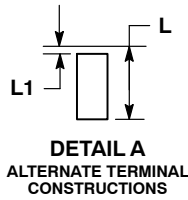
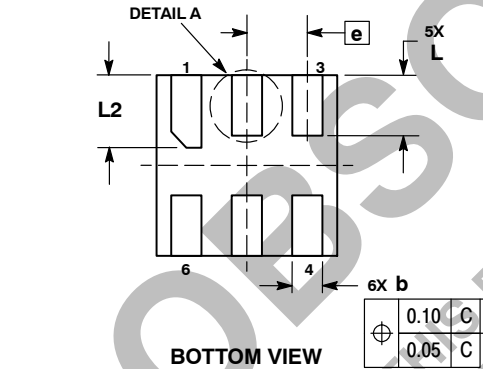
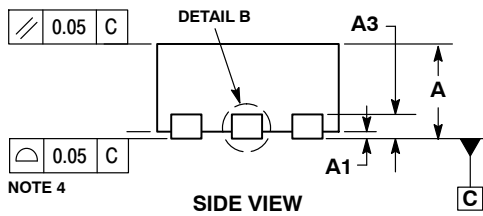
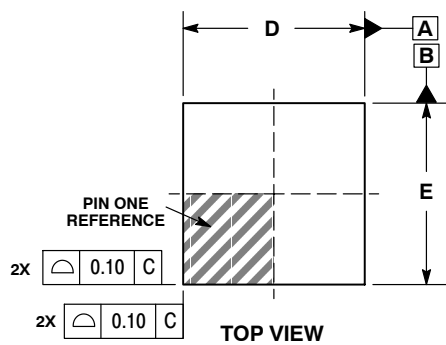

- NOTES:
1. DIMENSIONING AND TOLERANCING PER ASME Y14.5M, 1994.
 2. CONTROLLING DIMENSION: MILLIMETERS.
 3. DIMENSION b APPLIES TO PLATED TERMINAL AND IS MEASURED BETWEEN 0.15 AND 0.30mm FROM TERMINAL TIP.
 4. COPLANARITY APPLIES TO THE EXPOSED PAD AS WELL AS THE TERMINALS.

MILLIMETERS		
DIM	MIN	MAX
A	0.70	0.80
A1	0.00	0.05
A3	0.20 REF	
b	0.20	0.30
D	1.50 BSC	
E	1.50 BSC	
e	0.50 BSC	
L	0.40	0.60
L1	---	0.15
L2	0.50	0.70

GENERIC MARKING DIAGRAM*

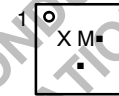

- X = Specific Device Code
- M = Date Code
- = Pb-Free Package

(*Note: Microdot may be in either location)

*This information is generic. Please refer to device data sheet for actual part marking. Pb-Free indicator, "G" or microdot "■", may or may not be present.

RECOMMENDED MOUNTING FOOTPRINT*

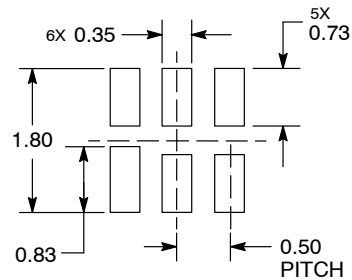

DIMENSIONS: MILLIMETERS

*For additional information on our Pb-Free strategy and soldering details, please download the ON Semiconductor Soldering and Mounting Techniques Reference Manual, SOLDERRM/D.

CAT6219

ORDERING INFORMATION (Notes 7 – 9)

Device Order Number	Specific Device Marking	Package Type	V _{OUT} Voltage (V)	Lead Finish	Shipping (Note 10)
CAT6219-125TDGT3	US	TSOT-23-5	1.25	NiPdAu	Tape & Reel, 3,000 Units / Reel
CAT6219-180TDGT3	RV		1.80		
CAT6219-250TDGT3	US		2.50		
CAT6219-280TDGT3	RV		2.80		
CAT6219-285TDGT3	RV		2.85		
CAT6219-300TDGT3	US		3.00		
CAT6219-330TDGT3	RV		3.30		
CAT6219ADJTD-GT3	UM		Adjustable		
CAT6219ADJVP5GT4	AF	TDFN-6 (2.0 x 2.0)	Adjustable		Tape & Reel, 4,000 Units / Reel
CAT6219180VP5GT4	AB		1.80		
CAT6219VP5330GT4	AB		3.30		
CAT6219-280MV2T3	S	WDFN-6 (1.5 x 1.5)	2.80		Tape & Reel, 3,000 Units / Reel
CAT6219-285MV2T3	T		2.85		
CAT6219-330MV2T3	U		3.30		
CAT6219ADJMV2-T3	V		Adjustable		

7. All packages are RoHS-compliant (Lead-free, Halogen-free).
8. The standard lead finish is NiPdAu pre-plated (PPF) lead frames.
9. For other voltage options, please contact your nearest ON Semiconductor Sales office.
10. For information on tape and reel specifications, including part orientation and tape sizes, please refer to our Tape and Reel Packaging Specifications Brochure, BRD8011/D.
11. For detailed information and a breakdown of device nomenclature and numbering systems, please see the ON Semiconductor Device Nomenclature document, TND310/D, available at www.onsemi.com

ON Semiconductor and  are registered trademarks of Semiconductor Components Industries, LLC (SCILLC). SCILLC owns the rights to a number of patents, trademarks, copyrights, trade secrets, and other intellectual property. A listing of SCILLC's product/patent coverage may be accessed at www.onsemi.com/site/pdf/Patent-Marking.pdf. SCILLC reserves the right to make changes without further notice to any products herein. SCILLC makes no warranty, representation or guarantee regarding the suitability of its products for any particular purpose, nor does SCILLC assume any liability arising out of the application or use of any product or circuit, and specifically disclaims any and all liability, including without limitation special, consequential or incidental damages. "Typical" parameters which may be provided in SCILLC data sheets and/or specifications can and do vary in different applications and actual performance may vary over time. All operating parameters, including "Typicals" must be validated for each customer application by customer's technical experts. SCILLC does not convey any license under its patent rights nor the rights of others. SCILLC products are not designed, intended, or authorized for use as components in systems intended for surgical implant into the body, or other applications intended to support or sustain life, or for any other application in which the failure of the SCILLC product could create a situation where personal injury or death may occur. Should Buyer purchase or use SCILLC products for any such unintended or unauthorized application, Buyer shall indemnify and hold SCILLC and its officers, employees, subsidiaries, affiliates, and distributors harmless against all claims, costs, damages, and expenses, and reasonable attorney fees arising out of, directly or indirectly, any claim of personal injury or death associated with such unintended or unauthorized use, even if such claim alleges that SCILLC was negligent regarding the design or manufacture of the part. SCILLC is an Equal Opportunity/Affirmative Action Employer. This literature is subject to all applicable copyright laws and is not for resale in any manner.

PUBLICATION ORDERING INFORMATION

LITERATURE FULFILLMENT:

Literature Distribution Center for ON Semiconductor
P.O. Box 5163, Denver, Colorado 80217 USA
Phone: 303-675-2175 or 800-344-3860 Toll Free USA/Canada
Fax: 303-675-2176 or 800-344-3867 Toll Free USA/Canada
Email: orderlit@onsemi.com

N. American Technical Support: 800-282-9855 Toll Free
USA/Canada
Europe, Middle East and Africa Technical Support:
Phone: 421 33 790 2910
Japan Customer Focus Center
Phone: 81-3-5817-1050

ON Semiconductor Website: www.onsemi.com

Order Literature: <http://www.onsemi.com/orderlit>

For additional information, please contact your local Sales Representative