

# CAT6221

## 300 mA CMOS Dual LDO Regulator

### Description

The 300 mA CMOS Dual LDO CAT6221 combines in a single TSOT-23 6-lead package two low dropout regulators (LDO), each with its own enable pin.

The regulator outputs drive loads up to 300 mA. By design, the dual LDO provides fast response time during load current and line voltage changes.

Each LDO is optimized for low noise and high crosstalk isolation. With zero shut down current and a low quiescent current of 100  $\mu$ A, the dual LDO is ideal for battery-operated devices with supply voltage from 2.3 V to 5.5 V.

The dual LDO offers 1% initial accuracy and very low dropout voltage, typical 210 mV at 300 mA. Stable operation is provided with small 1  $\mu$ F ceramic output capacitors, reducing required board space and component cost.

Other features include fold-back current limit and thermal protection.

The dual LDO is available in the tiny 6-lead TSOT-23 package with a maximum height of 0.8 mm.

### Features

- Two Outputs with Guaranteed 300 mA Peak Output Current
- Low Dropout Voltages of 210 mV Typical at 300 mA
- Stable with Ceramic Output Capacitors
- Independent Enable Pins
- Under Voltage Lockout
- No-load Ground Current of 100  $\mu$ A Typical
- Full-load Ground Current of 160  $\mu$ A Typical
- $\pm 1.0\%$  Output Voltage Initial Accuracy ( $V_{OUT} \geq 2.0$  V)
- $\pm 2.0\%$  Accuracy Over Temperature ( $V_{OUT} \geq 2.0$  V)
- "Zero" Current Shutdown Mode
- Fold-back Current Limit and Thermal Protection
- TSOT-23 6-lead, 0.8 mm Height Package
- These Devices are Pb-Free, Halogen Free/BFR Free and are RoHS Compliant

### Applications

- Cellular Phones
- Battery-powered Devices
- Consumer Electronics



**ON Semiconductor®**

<http://onsemi.com>



**TSOT-23  
TD SUFFIX  
CASE 419AF**

### PIN CONNECTIONS

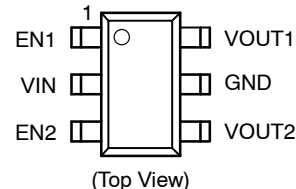

### MARKING DIAGRAM

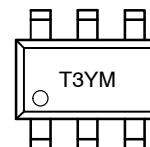

T3 = CAT6221 Device Code  
Y = Production Year (last digit)  
M = Production Month: 1 - 9, A, B, C

### PIN FUNCTION

| Pin # | Name  | Function                              |
|-------|-------|---------------------------------------|
| 1     | EN1   | Enable input (active high) for VOUT1. |
| 2     | VIN   | Supply voltage input.                 |
| 3     | EN2   | Enable input (active high) for VOUT2. |
| 4     | VOUT2 | LDO Output Voltage 2.                 |
| 5     | GND   | Ground reference.                     |
| 6     | VOUT1 | LDO Output Voltage 1.                 |

### ORDERING INFORMATION

See detailed ordering and shipping information in the package dimensions section on page 10 of this data sheet.

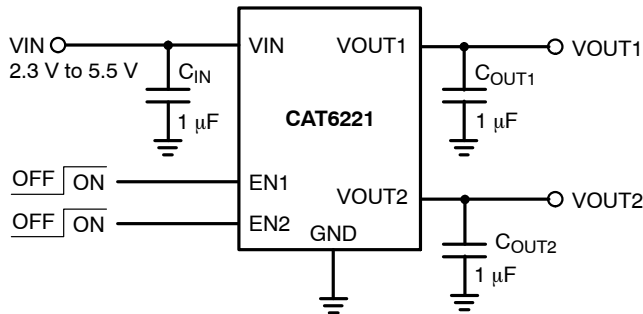

Figure 1. Typical Application Circuit

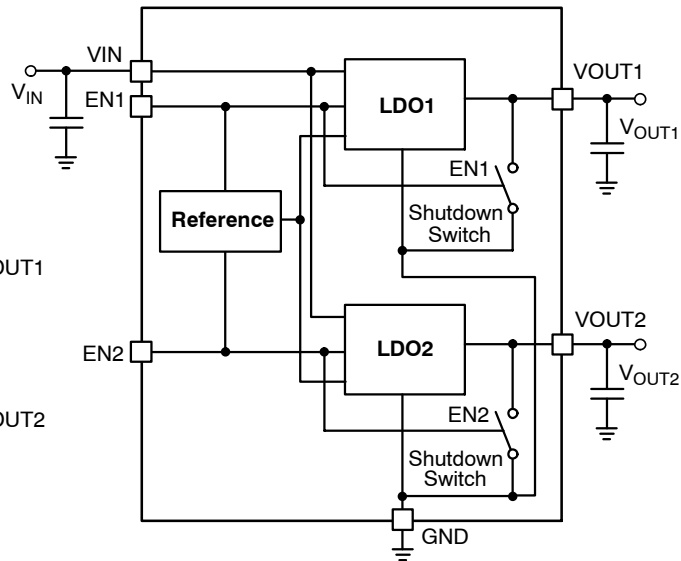

Figure 2. CAT6221 Functional Block Diagram

**Pin Function**

**VIN** is the supply pin for the LDO. A small 1 μF ceramic bypass capacitor is required between the VIN pin and ground near the device. When using longer connections to the power supply, CIN value can be increased without limit. The operating input voltage range is from 2.3 V to 5.5 V.

**EN1 & 2** are the enable control logic (active high) for the regulator outputs.

**VOUT1 & 2** are the LDO regulator outputs. A small 1 μF ceramic bypass capacitor is required between the VOUT

pins and ground. For better transient response, its value can be increased to 4.7 μF.

The capacitor should be located near the device. For the TSOT23 6-lead package, a continuous 300 mA output current for both LDOs may turn-on the thermal protection.

On each output, a 250 Ω internal shutdown switch discharges the output capacitor in the no-load condition.

**GND** is the ground reference for the LDO. The pin must be connected to the ground plane on the PCB.

Table 1. ABSOLUTE MAXIMUM RATINGS

| Parameter                            | Rating                      | Unit |
|--------------------------------------|-----------------------------|------|
| VIN                                  | 0 to 6.5                    | V    |
| VEN, VOUT                            | -0.3 to VIN + 0.3           | V    |
| Junction Temperature, TJ             | +150                        | °C   |
| Power Dissipation, PD                | Internally Limited (Note 1) | mW   |
| Storage Temperature Range, TS        | -65 to +150                 | °C   |
| Lead Temperature (soldering, 5 sec.) | 260                         | °C   |
| ESD Rating (Human Body Model)        | 3                           | kV   |

Stresses exceeding Maximum Ratings may damage the device. Maximum Ratings are stress ratings only. Functional operation above the Recommended Operating Conditions is not implied. Extended exposure to stresses above the Recommended Operating Conditions may affect device reliability.

Table 2. RECOMMENDED OPERATING CONDITIONS (Note 2)

| Parameter                                | Range       | Unit |
|--|-------------|------|
| VIN                                      | 2.3 to 5.5  | V    |
| VEN                                      | 0 to VIN    | V    |
| Junction Temperature Range, TJ           | -40 to +125 | °C   |
| Package Thermal Resistance (TSOT23), θJA | 235         | °C/W |

NOTE: Typical application circuit with external components is shown above.

1. The maximum allowable power dissipation at any TA (ambient temperature) is  $P_{Dmax} = (T_{Jmax} - T_A) / \theta_{JA}$ . Exceeding the maximum allowable power dissipation will result in excessive die temperature, and the regulator will go into thermal shutdown.
2. The device is not guaranteed to work outside its operating rating.

**Table 3. ELECTRICAL OPERATING CHARACTERISTICS** (Note 3)

( $V_{IN} = V_{OUT} + 1.0$  V,  $V_{EN} = \text{High}$ ,  $I_{OUT} = 100$   $\mu\text{A}$ ,  $C_{IN} = C_{OUT} = 1$   $\mu\text{F}$ , ambient temperature of 25°C (over recommended operating conditions unless specified otherwise). **Bold numbers** apply for the entire junction temperature range.)

| Symbol        | Parameter                              | Conditions                                       | Min         | Typ       | Max         | Unit                |
|---------------|--|--|-------------|-----------|-------------|---------------------|
| $V_{OUT-ACC}$ | Output Voltage Accuracy                | Initial accuracy (Note 4)                        | -1.0        |           | +1.0        | %                   |
|               |  |  | <b>-2.0</b> |           | <b>+2.0</b> |                     |
| $TC_{OUT}$    | Output Voltage Temp. Coefficient       |  |             | 40        |             | ppm/°C              |
| $V_{R-LINE}$  | Line Regulation                        | $V_{IN} = V_{OUT} + 1.0$ V to 5.5 V              | -0.2        | $\pm 0.1$ | +0.2        | %/V                 |
|               |  |  | <b>-0.4</b> |           | <b>+0.4</b> |                     |
| $V_{R-LOAD}$  | Load Regulation                        | $I_{OUT} = 100$ $\mu\text{A}$ to 300 mA          |             | 0.9       | 1.5         | %                   |
|               |  |  |             |           | <b>2</b>    |                     |
| $V_{DROP}$    | Dropout Voltage (Note 5)               | $I_{OUT} = 300$ mA                               |             | 210       | 280         | mV                  |
|               |  |  |             |           | <b>350</b>  |                     |
| $I_{GND}$     | Ground Current                         | Both LDOs Enabled<br>$I_{OUT} = 0$ $\mu\text{A}$ |             | 100       | 140         | $\mu\text{A}$       |
|               |  |  |             |           | <b>170</b>  |                     |
|               |  | One LDO Enabled<br>$I_{OUT} = 0$ $\mu\text{A}$   |             | 160       |             |                     |
|               |  |  |             | 55        | 75          |                     |
|               | One LDO Enabled<br>$I_{OUT} = 300$ mA  |  | 85          |           |             |                     |
| $I_{GND-SD}$  | Shutdown Ground Current                | $V_{EN} < 0.4$ V                                 |             |           | 2           | $\mu\text{A}$       |
|               |  |  |             |           | <b>4</b>    |                     |
| PSRR          | Power Supply Rejection Ratio           | $f = 1$ kHz                                      |             | 60        |             | dB                  |
|               |  | $f = 20$ kHz                                     |             | 45        |             |                     |
| $I_{SC}$      | Output short circuit current limit     | $V_{OUT} = 0$ V                                  |             | 130       |             | mA                  |
| $T_{ON}$      | Turn-On Time                           |  |             | 150       |             | $\mu\text{s}$       |
| $e_N$         | Output Noise Voltage (Note 6)          | BW = 10 Hz to 100 kHz                            |             | 95        |             | $\mu\text{V}_{rms}$ |
| $R_{OUT-SH}$  | Shutdown Switch Resistance             |  |             | 250       |             | $\Omega$            |
| $V_{IN-UVLO}$ | Under voltage lockout threshold        |  |             | 2.15      |             | V                   |
| ESR           | $C_{OUT}$ equivalent series resistance |  | 5           |           | 500         | m $\Omega$          |

**ENABLE INPUT (EN1, EN2)**

|          |                      |                         |            |      |            |               |
|----------|----------------------|-------------------------|------------|------|------------|---------------|
| $V_{HI}$ | Logic High Level     | $V_{IN} = 2.3$ to 5.5 V | <b>1.8</b> |      |            | V             |
| $V_{LO}$ | Logic Low Level      | $V_{IN} = 2.3$ to 5.5 V |            |      | <b>0.4</b> | V             |
| $I_{EN}$ | Enable Input Current | $V_{EN} = 0.4$ V        |            | 0.05 | <b>1</b>   | $\mu\text{A}$ |
|          |                      | $V_{EN} = V_{IN}$       |            | 0.1  | <b>1</b>   |               |

**THERMAL PROTECTION**

|           |                    |  |  |     |  |    |
|-----------|--------------------|--|--|-----|--|----|
| $T_{SD}$  | Thermal Shutdown   |  |  | 160 |  | °C |
| $T_{HYS}$ | Thermal Hysteresis |  |  | 10  |  | °C |

3. Specification for 2.8 V output version unless specified otherwise.
4. For  $V_{OUT} < 2.0$  V, the initial accuracy is  $\pm 2\%$  and across temp is  $\pm 3\%$ .
5. Dropout voltage is defined as the input-to-output differential at which the output voltage drops 2% below its nominal value measured at 1 V differential. During test, the input voltage stays always above the minimum 2.3 V.
6. Specification for 1.8 V output version.

**TYPICAL CHARACTERISTICS** (shown for 2.8 V/1.8 V outputs option)

( $V_{IN} = 3.8\text{ V}$ ,  $I_{OUT} = 100\ \mu\text{A}$ ,  $EN1 = EN2 = V_{IN}$ ,  $C_{IN} = C_{OUT} = 1\ \mu\text{F}$ ,  $T_A = 25^\circ\text{C}$  unless otherwise specified.)

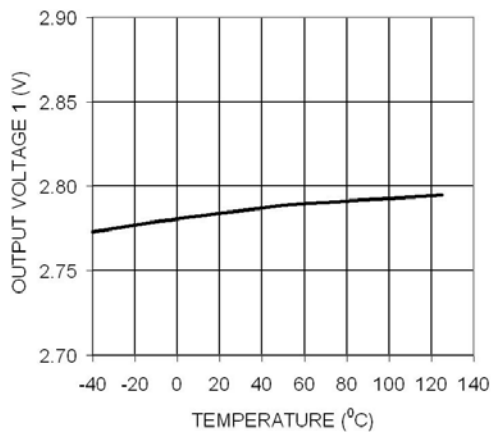

**Figure 3. Output Voltage 1 vs. Temperature**

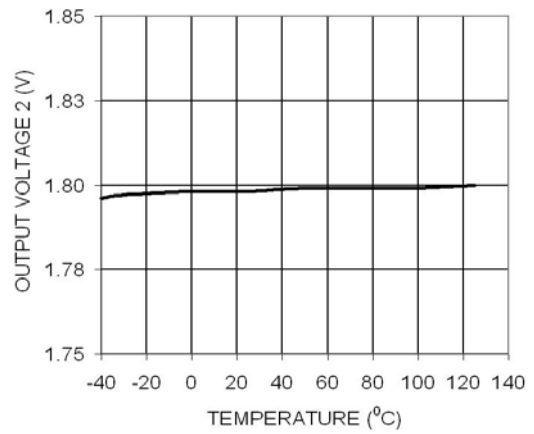

**Figure 4. Output Voltage 2 vs. Temperature**

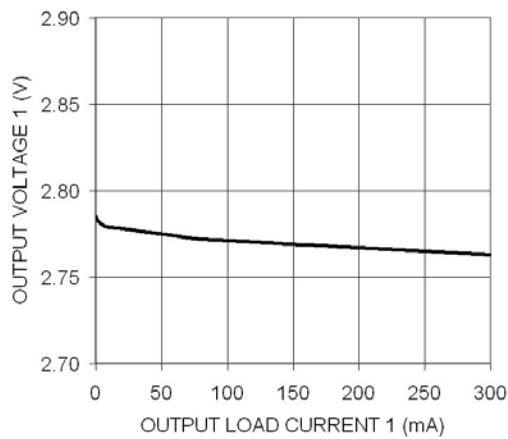

**Figure 5. Load Regulation VOUT1**

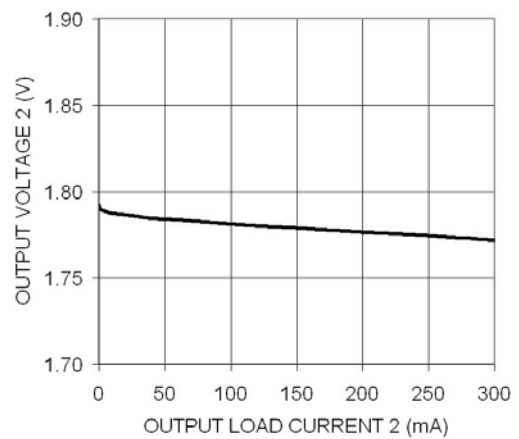

**Figure 6. Load Regulation VOUT2**

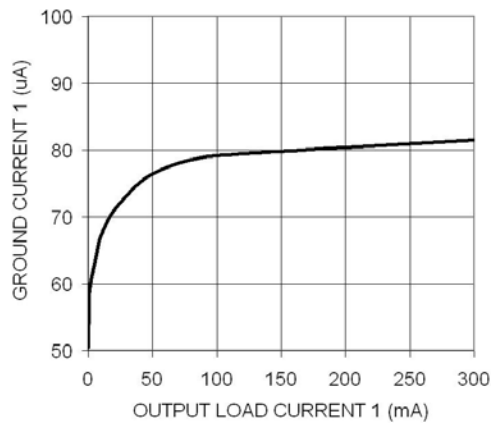

**Figure 7. Ground Current (EN2 = GND)**

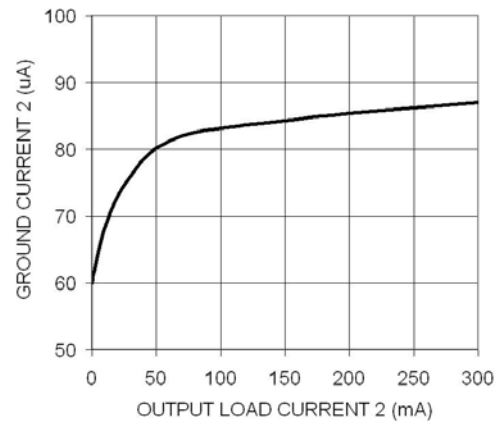

**Figure 8. Ground Current (EN1 = GND)**

**TYPICAL CHARACTERISTICS** (shown for 2.8 V/1.8 V outputs option)

( $V_{IN} = 3.8\text{ V}$ ,  $I_{OUT} = 100\ \mu\text{A}$ ,  $EN1 = EN2 = V_{IN}$ ,  $C_{IN} = C_{OUT} = 1\ \mu\text{F}$ ,  $T_A = 25^\circ\text{C}$  unless otherwise specified.)

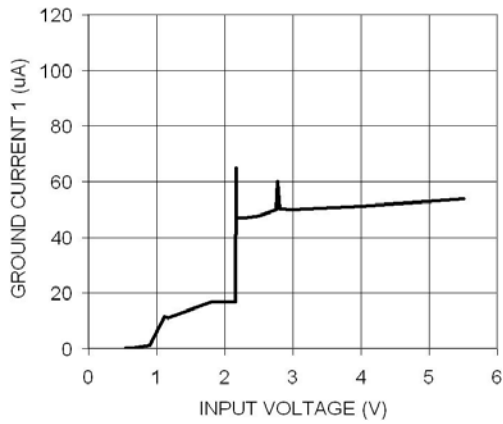

**Figure 9. Ground Current (EN2 = GND)**

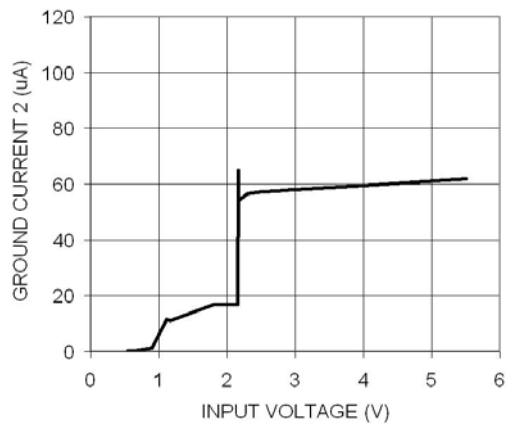

**Figure 10. Ground Current (EN1 = GND)**

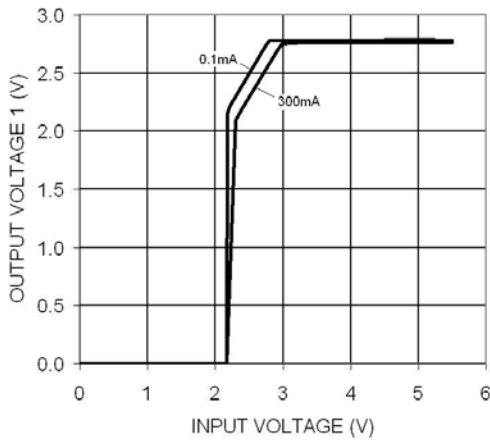

**Figure 11. Output 1 Dropout Characteristics**

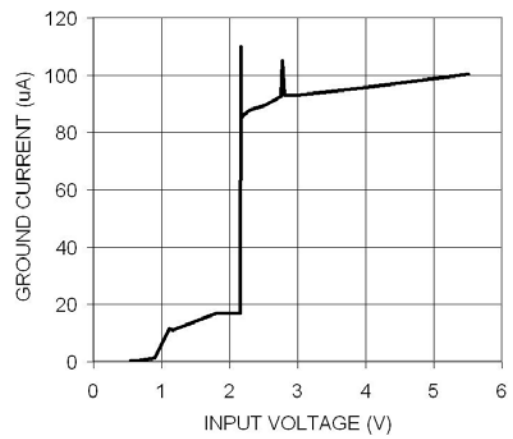

**Figure 12. Ground Current vs. Input Voltage**

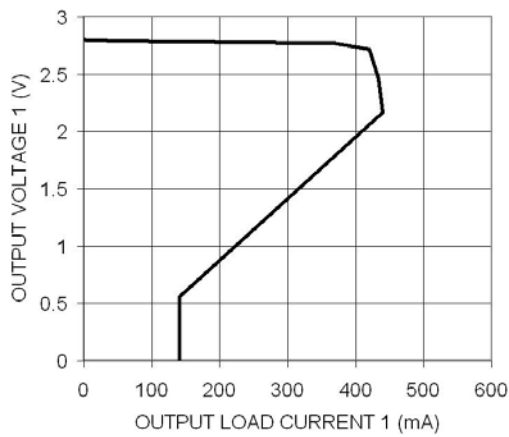

**Figure 13. Output Voltage 1 vs. Load Current 1**

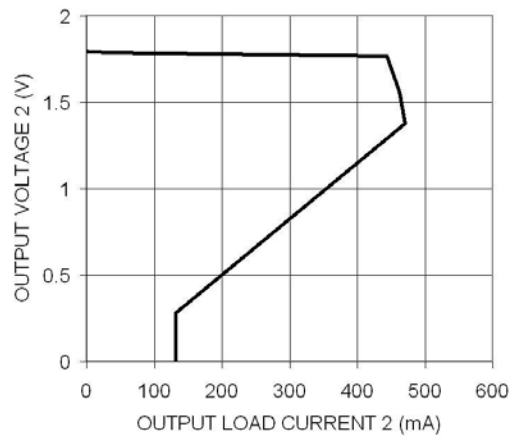

**Figure 14. Output Voltage 2 vs. Load Current 2**

**TYPICAL CHARACTERISTICS** (shown for 2.8 V/1.8 V outputs option)

( $V_{IN} = 3.8\text{ V}$ ,  $I_{OUT} = 100\ \mu\text{A}$ ,  $EN1 = EN2 = V_{IN}$ ,  $C_{IN} = C_{OUT} = 1\ \mu\text{F}$ ,  $T_A = 25^\circ\text{C}$  unless otherwise specified.)

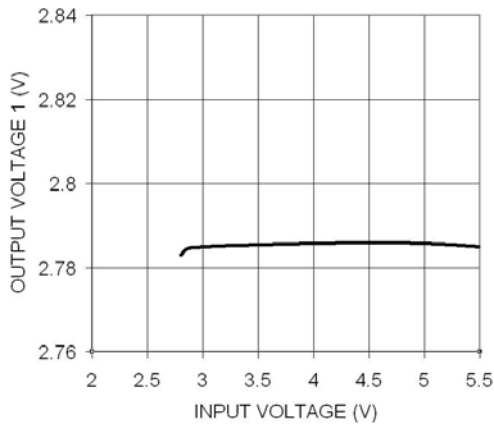

Figure 15. Line Regulation VOUT1

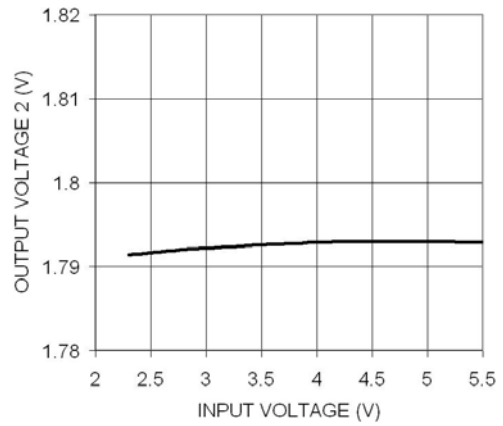

Figure 16. Line Regulation VOUT2

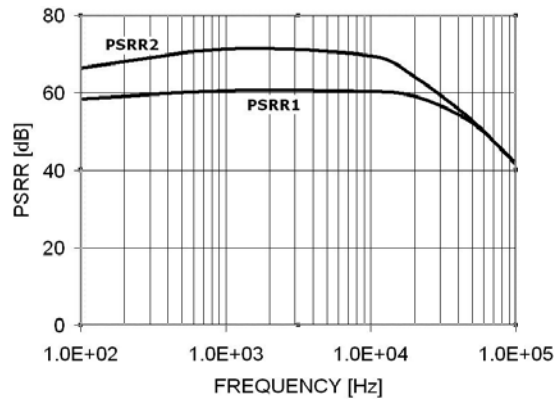
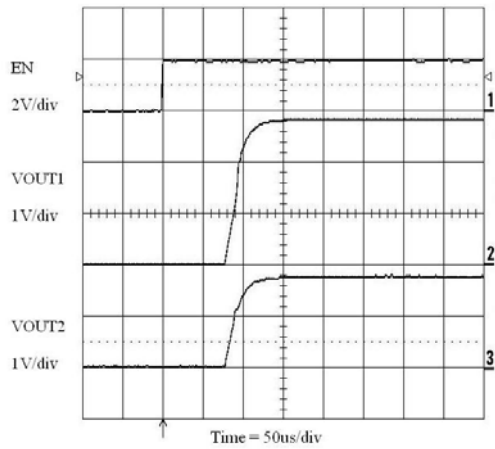

Figure 17. PSRR 1 & 2 vs. Frequency (30 mA Load)

**TRANSIENT CHARACTERISTICS** (shown for 2.8 V/1.8 V outputs option)

( $V_{IN} = 3.8\text{ V}$ ,  $I_{OUT} = 100\ \mu\text{A}$ ,  $EN1 = EN2 = V_{IN}$ ,  $C_{IN} = C_{OUT} = 1\ \mu\text{F}$ ,  $T_A = 25^\circ\text{C}$  unless otherwise specified.)



**Figure 18. Enable Turn-on (100  $\mu\text{A}$  Loads)**

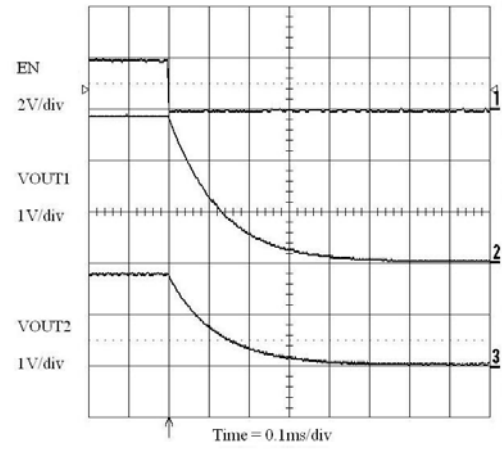

**Figure 19. Enable Turn-off (100  $\mu\text{A}$  Loads)**

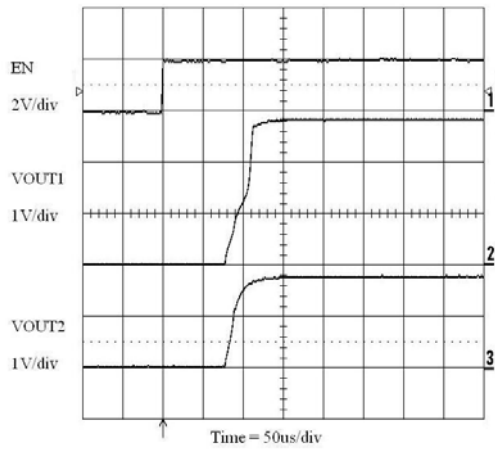

**Figure 20. Enable Turn-on (300 mA/100  $\mu\text{A}$  Loads)**

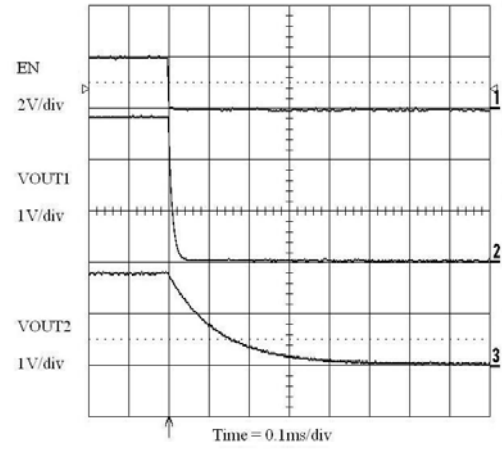

**Figure 21. Enable Turn-off (300 mA/100  $\mu\text{A}$  Loads)**

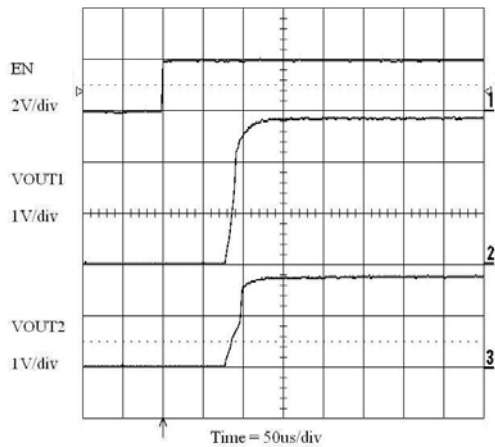

**Figure 22. Enable Turn-on (100  $\mu\text{A}$ /300 mA Loads)**

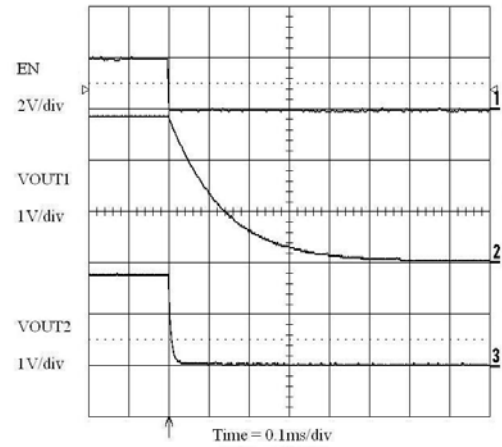
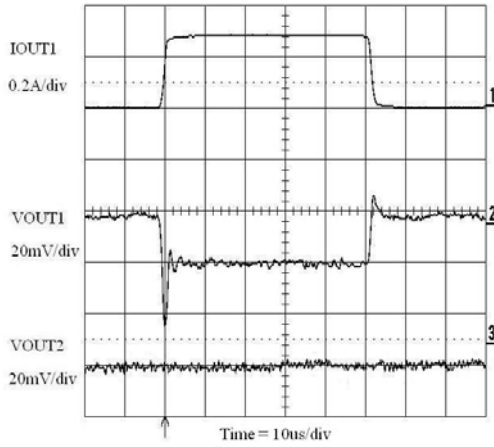

**Figure 23. Enable Turn-off (100  $\mu\text{A}$ /300 mA Loads)**

NOTE: All transient characteristics are generated using the evaluation board CAT621XEVAL1.

**TRANSIENT CHARACTERISTICS** (shown for 2.8 V/1.8 V outputs option)

( $V_{IN} = 3.8\text{ V}$ ,  $I_{OUT} = 100\ \mu\text{A}$ ,  $EN1 = EN2 = V_{IN}$ ,  $C_{IN} = C_{OUT} = 1\ \mu\text{F}$ ,  $T_A = 25^\circ\text{C}$  unless otherwise specified.)



**Figure 24. VOUT1 Load Transient Response (0.1 to 300 mA)**

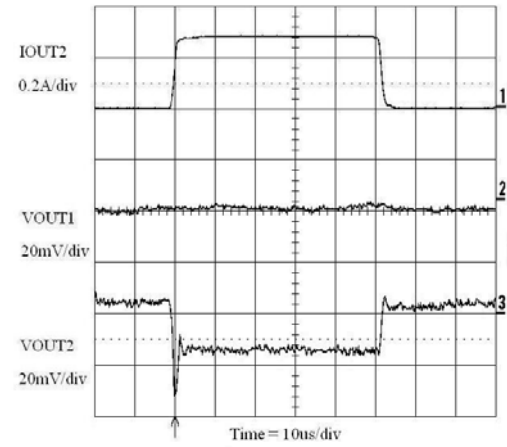

**Figure 25. VOUT2 Load Transient Response (0.1 to 300 mA)**

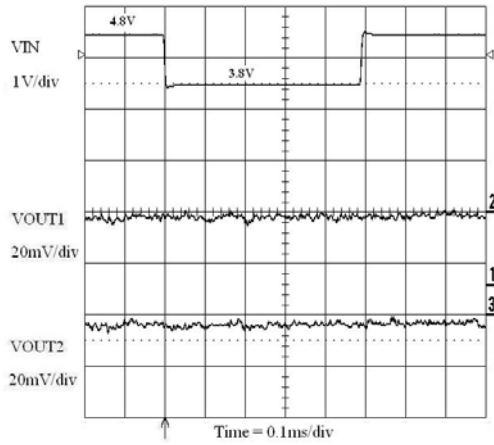

**Figure 26. Line Transient Response (0.1 mA Loads)**

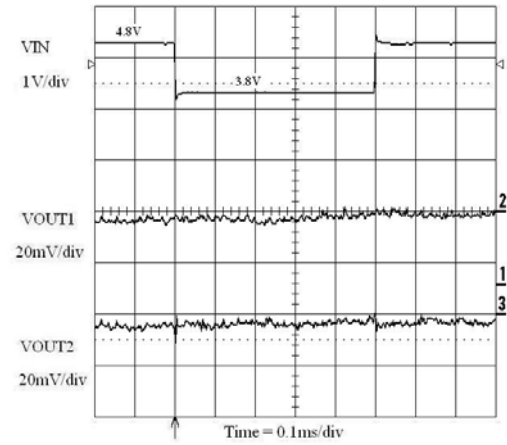

**Figure 27. Line Transient Response (0.1/100 mA Loads)**

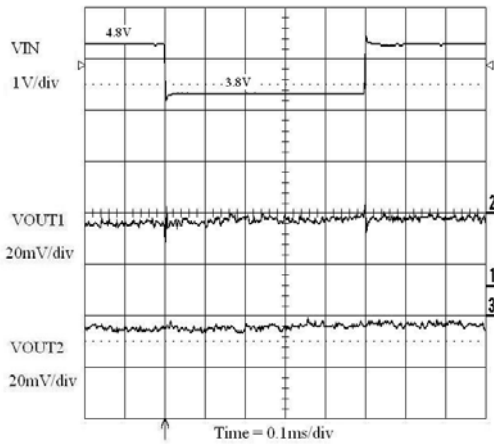

**Figure 28. Line Transient Response (100/0.1 mA Loads)**

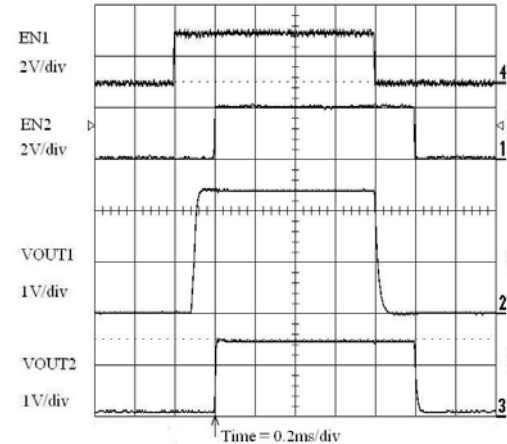

**Figure 29. Separate Enable Operation (100 mA Loads)**

NOTE: All transient characteristics are generated using the evaluation board CAT621XEVAL1.



# CAT6221

## PACKAGE DIMENSIONS

TSOT-23, 6 LEAD  
CASE 419AF-01  
ISSUE O

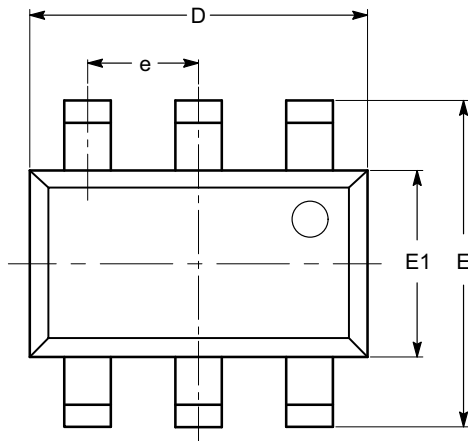

TOP VIEW

| SYMBOL   | MIN      | NOM  | MAX  |
|----------|----------|------|------|
| A        |          |      | 1.00 |
| A1       | 0.01     | 0.05 | 0.10 |
| A2       | 0.80     | 0.87 | 0.90 |
| b        | 0.30     |      | 0.45 |
| c        | 0.12     | 0.15 | 0.20 |
| D        | 2.90 BSC |      |      |
| E        | 2.80 BSC |      |      |
| E1       | 1.60 BSC |      |      |
| e        | 0.95 TYP |      |      |
| L        | 0.30     | 0.40 | 0.50 |
| L1       | 0.60 REF |      |      |
| L2       | 0.25 BSC |      |      |
| $\theta$ | 0°       |      | 8°   |

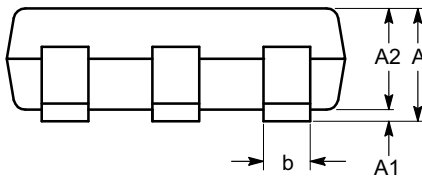

SIDE VIEW

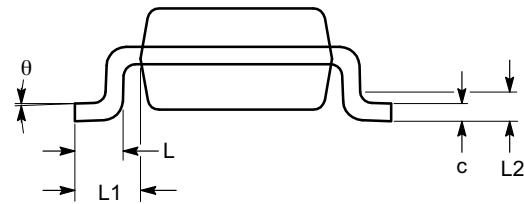

END VIEW

**Notes:**

- (1) All dimensions are in millimeters. Angles in degrees.
- (2) Complies with JEDEC MO-193.

Example of Ordering Information (Note 9)

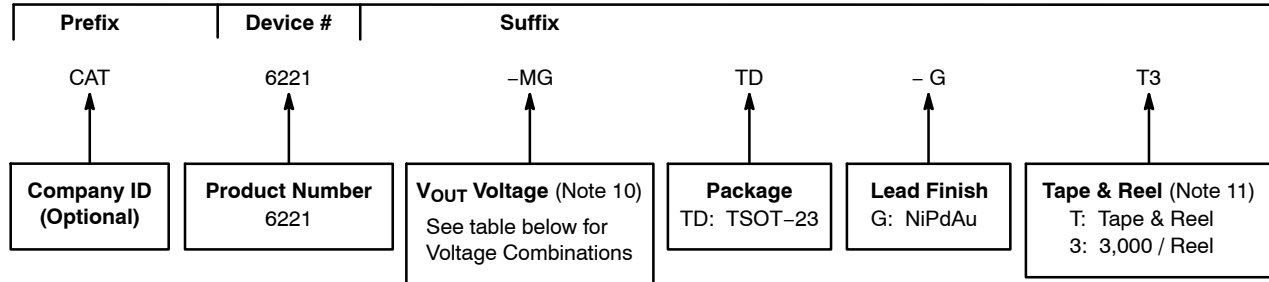

ORDERING INFORMATION

| Orderable Part Number | V <sub>OUT</sub> Voltage | Package | Shipping            |
|-----------------------|--------------------------|---------|---------------------|
| CAT6221-JFTD-GT3      | 2.5 V / 1.5 V            | TSOT-23 | 3,000 / Tape & Reel |
| CAT6221-JGTD-GT3      | 2.5 V / 1.8 V            | TSOT-23 | 3,000 / Tape & Reel |
| CAT6221-JLTD-GT3      | 2.5 V / 2.7 V            | TSOT-23 | 3,000 / Tape & Reel |
| CAT6221-JPTD-GT3      | 2.5 V / 3.0 V            | TSOT-23 | 3,000 / Tape & Reel |
| CAT6221-MFTD-GT3      | 2.8 V / 1.5 V            | TSOT-23 | 3,000 / Tape & Reel |
| CAT6221-MGTD-GT3      | 2.8 V / 1.8 V            | TSOT-23 | 3,000 / Tape & Reel |
| CAT6221-MLTD-GT3      | 2.8 V / 2.7 V            | TSOT-23 | 3,000 / Tape & Reel |
| CAT6221-MPTD-GT3      | 2.8 V / 3.0 V            | TSOT-23 | 3,000 / Tape & Reel |
| CAT6221-PFTD-GT3      | 3.0 V / 1.5 V            | TSOT-23 | 3,000 / Tape & Reel |
| CAT6221-PGTD-GT3      | 3.0 V / 1.8 V            | TSOT-23 | 3,000 / Tape & Reel |
| CAT6221-PLTD-GT3      | 3.0 V / 2.7 V            | TSOT-23 | 3,000 / Tape & Reel |
| CAT6221-PPTD-GT3      | 3.0 V / 3.0 V            | TSOT-23 | 3,000 / Tape & Reel |
| CAT6221-SFTD-GT3      | 3.3 V / 1.5 V            | TSOT-23 | 3,000 / Tape & Reel |
| CAT6221-SGTD-GT3      | 3.3 V / 1.8 V            | TSOT-23 | 3,000 / Tape & Reel |
| CAT6221-SLTD-GT3      | 3.3 V / 2.7 V            | TSOT-23 | 3,000 / Tape & Reel |
| CAT6221-SPTD-GT3      | 3.3 V / 3.0 V            | TSOT-23 | 3,000 / Tape & Reel |

7. All packages are RoHS-compliant (Lead-free, Halogen-free).
8. The standard finish is NiPdAu pre-plated (PPF) lead frames.
9. The device used in the above example is a CAT6221-MGTD-GT3 (V<sub>OUT1</sub> = 2.8 V, V<sub>OUT2</sub> = 1.8 V, in a TSOT-23 package, NiPdAu, Tape & Reel).
10. For other voltage options, please contact your nearest ON Semiconductor Sales office.
11. For information on tape and reel specifications, including part orientation and tape sizes, please refer to our Tape and Reel Packaging Specifications Brochure, BRD8011/D.

ON Semiconductor and  are registered trademarks of Semiconductor Components Industries, LLC (SCILLC). SCILLC reserves the right to make changes without further notice to any products herein. SCILLC makes no warranty, representation or guarantee regarding the suitability of its products for any particular purpose, nor does SCILLC assume any liability arising out of the application or use of any product or circuit, and specifically disclaims any and all liability, including without limitation special, consequential or incidental damages. "Typical" parameters which may be provided in SCILLC data sheets and/or specifications can and do vary in different applications and actual performance may vary over time. All operating parameters, including "Typicals" must be validated for each customer application by customer's technical experts. SCILLC does not convey any license under its patent rights nor the rights of others. SCILLC products are not designed, intended, or authorized for use as components in systems intended for surgical implant into the body, or other applications intended to support or sustain life, or for any other application in which the failure of the SCILLC product could create a situation where personal injury or death may occur. Should Buyer purchase or use SCILLC products for any such unintended or unauthorized application, Buyer shall indemnify and hold SCILLC and its officers, employees, subsidiaries, affiliates, and distributors harmless against all claims, costs, damages, and expenses, and reasonable attorney fees arising out of, directly or indirectly, any claim of personal injury or death associated with such unintended or unauthorized use, even if such claim alleges that SCILLC was negligent regarding the design or manufacture of the part. SCILLC is an Equal Opportunity/Affirmative Action Employer. This literature is subject to all applicable copyright laws and is not for resale in any manner.

PUBLICATION ORDERING INFORMATION

**LITERATURE FULFILLMENT:**  
 Literature Distribution Center for ON Semiconductor  
 P.O. Box 5163, Denver, Colorado 80217 USA  
**Phone:** 303-675-2175 or 800-344-3860 Toll Free USA/Canada  
**Fax:** 303-675-2176 or 800-344-3867 Toll Free USA/Canada  
**Email:** orderlit@onsemi.com

**N. American Technical Support:** 800-282-9855 Toll Free  
 USA/Canada  
**Europe, Middle East and Africa Technical Support:**  
 Phone: 421 33 790 2910  
**Japan Customer Focus Center**  
 Phone: 81-3-5773-3850

**ON Semiconductor Website:** [www.onsemi.com](http://www.onsemi.com)  
**Order Literature:** <http://www.onsemi.com/orderlit>  
 For additional information, please contact your local  
 Sales Representative