

THE ALLPOWER SOURCE

# EMI SUPPRESSION DEVICES

FULL RANGE OF FERRITE BEADS  
LARGE ASSORTMENT OF FERRITE CLAMPS



- ATTENUATION OF CONDUCTED NOISE
- COMMON MODE BALUNS
- D-SUBCONNECTOR NOISE SUPPRESSORS
- FLAT CABLE CLAMPS
- FERRITE BEADS

ALLPOWER DIVISION  
TECHNOLOGY DYNAMICS INC.

100 School Street, Bergenfield, NJ 07621 Phone: (201) 385-0500, Fax: (201) 385-0702

[www.theallpower.com](http://www.theallpower.com)

1. Applications and Characteristics:

If the design frequency is below 300KHz, the preferred choice of RF circuits for the iron powder core are: DC power supply chokes, motors, dimmer control filteres and other EMI/RFI circuits.



2. Temperature Effects:

The iron powder core is well suited from -55°C to +125°C. Because the iron powder core does not have a low curie temperature it will function to several hundred degrees Celcius. However, continued operation above 200°C may result in a permanent shift in characteristic.

EPOXY COATING: 94V-0  
 COLOR CODE: YELLOW/WHITE

5. Iron Powder Material Properties

PROPERTY	UNIT	SYBOL	26
Initial Permeability		$\mu_i$	75
Curie Temperature	°C	Tc	≥300
Pratical Frequency Range	KHZ		1-300
Specific Gravity		d	6.7
Temperature Stability (+)	Ppm/°C		780

5. Dimensions and Magnetic Parameters

Symbols	Definitions
$L_e$	Effective path length
$A_e$	Effective cross-sectional area
$V_e$	Effective core volume
$A_L$	Inductance factor

ITEM	Mechanical Dimension			Magnetic Dimension			AL (nH/N <sup>2</sup> )		
	OD (mm)	ID (mm)	HT (mm)	$L_e$ cm <sup>2</sup>	$A_e$ cm <sup>2</sup>	$V_e$ cm <sup>2</sup>	M25 + 25%	M50 + 25%	M70 + 30%
T4x2x2	4.0 ± 0.2	2.0 ± 0.2	2.0 ± 0.2	0.9430	0.0200	0.1885	666	1333	1866
T6x3x2	6.0 ± 0.3	3.0 ± 0.2	2.0 ± 0.2	1.4130	0.0300	0.0423	666	1333	1866
T6x3x3	6.0 ± 0.3	3.0 ± 0.2	3.0 ± 0.3	1.4130	0.0450	0.0636	1000	2000	2800
T9x5x3	9.0 ± 0.3	5.0 ± 0.3	3.0 ± 0.3	2.1991	0.0600	0.1319	857	1714	2400
T10.3x5.4x5	10.3 ± 0.5	5.4 ± 0.3	5.0 ± 0.3	2.4661	0.1225	0.3021	1560	3121	4369
T12x6x4	12.0 ± 0.5	6.0 ± 0.3	4.0 ± 0.3	2.8274	0.1200	0.3392	1333	2666	3733
T12.7x7.1x4	12.7 ± 0.5	7.1 ± 0.3	4.0 ± 0.3	3.1101	0.1120	0.3483	1131	2262	3167
T12.7x7.1x6.35	12.7 ± 0.5	7.1 ± 0.3	6.35 ± 0.3	3.1101	0.1778	0.5530	1796	3592	5029
T12.7x7.7x6.5	12.7 ± 0.5	7.7 ± 0.3	6.5 ± 0.3	3.2044	0.1625	0.5207	1593	3186	4461
T14x8.4x5	14.0 ± 0.5	8.4 ± 0.3	5.0 ± 0.3	3.5185	0.1400	0.4926	1250	2500	3486
T14x8.4x6	14.0 ± 0.5	8.4 ± 0.3	6.0 ± 0.3	3.5185	0.1680	0.5911	1500	3000	4200
T14x8.4x7	14.0 ± 0.5	8.4 ± 0.3	7.0 ± 0.3	3.5185	0.1960	0.6896	1750	3500	4900
T15.8x9.5x6.8	15.8 ± 0.5	9.5 ± 0.5	6.8 ± 0.3	3.9741	0.2142	0.8512	1693	3387	4741
T16x12x8	16.0 ± 0.5	12.0 ± 0.5	8.0 ± 0.3	4.3982	0.1600	0.7037	1142	2285	3200
T18x10x7	18.0 ± 0.5	10.0 ± 0.5	7.0 ± 0.3	4.3982	0.2800	1.2315	2000	4000	5600
T20x10x8	20.0 ± 0.5	10.0 ± 0.5	8.0 ± 0.5	4.7123	0.4000	1.8849	2667	5333	7466
T20x10x10	20.0 ± 0.5	10.0 ± 0.5	10.0 ± 0.5	4.7123	0.5000	2.3561	3333	6666	9333
T22x14x6.5	22.0 ± 0.5	14.0 ± 0.5	6.5 ± 0.5	5.6548	0.2600	1.4702	1444	2888	4044
T22x14x8	22.0 ± 0.5	14.0 ± 0.5	8.0 ± 0.5	5.6548	0.3200	1.8095	1777	3555	4977
T22x14x12.7	22.0 ± 0.5	14.0 ± 0.5	12.7 ± 0.5	5.6548	0.5080	2.8726	2822	5644	7902
T25x15x8	25.0 ± 0.5	15.0 ± 0.5	8.0 ± 0.5	6.2831	0.4000	2.5132	2000	4000	5600
T25x15x10	25.0 ± 0.5	15.0 ± 0.5	10.0 ± 0.5	6.2831	0.5000	3.1415	2500	5000	7000
T25x15x13	25.0 ± 0.5	15.0 ± 0.5	13.0 ± 0.5	6.2831	0.6500	4.0840	3250	6500	9100
T25x15x15	25.0 ± 0.5	15.0 ± 0.5	15.0 ± 0.5	6.2831	0.7500	4.7123	3750	7500	10500
T28x18x8	28.0 ± 0.8	18.0 ± 0.8	8.0 ± 0.8	7.2256	0.4000	2.8902	1730	3478	4869
T28x18x16	28.0 ± 0.8	18.0 ± 0.8	16.0 ± 0.8	7.2256	0.8000	5.7805	3478	6857	9739
T31x19x13	31.0 ± 0.8	19.0 ± 0.8	13.0 ± 0.8	7.8540	0.7800	6.1261	3120	6240	8736
T31x19x16	31.0 ± 0.8	19.0 ± 0.8	16.0 ± 0.8	7.8540	0.9600	7.5398	3840	7680	10752
T35.6x25.4x12.7	35.6 ± 0.8	12.7 ± 0.8	12.7 ± 0.8	9.5818	0.6477	6.2061	2123	4247	5946
T35.6x25.4x15	35.6 ± 0.8	15.0 ± 0.8	15.0 ± 0.3	9.5818	0.7650	7.3301	2508	5016	7022



1. Material:

A2G A5N B-7 B-18

2. Ordering Code:

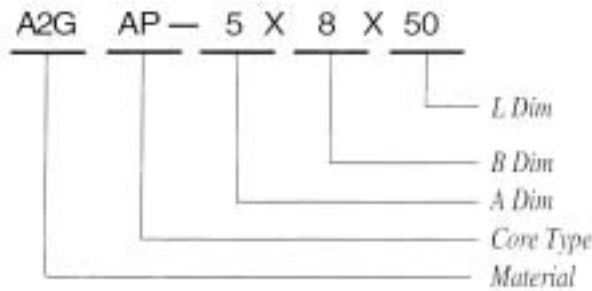

3. Shape:

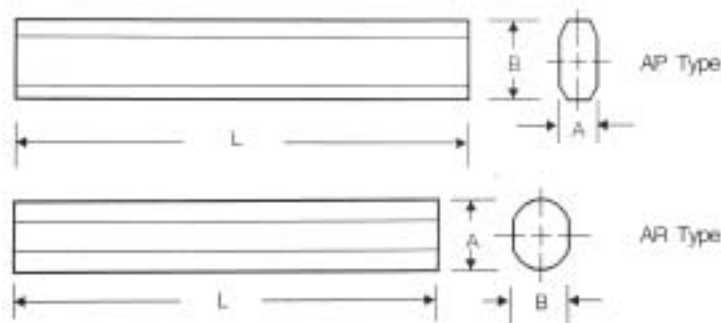

4. Dimensions: (m/m)

CORES	A	B	L
AP-1.9x7.8x49	1.9 ± 0.15	7.8 ± 0.3	49.0 ± 1.0
AP-2x8x40	2.0 ± 0.15	8.0 ± 0.3	40.0 ± 1.0
AP-2.5x8x40	2.5 ± 0.2	8.0 ± 0.3	40.0 ± 1.0
AP-2.8x8x46	2.8 ± 0.2	8.0 ± 0.3	46.0 ± 1.0
AP-3x7.5x45	3.0 ± 0.3	7.5 ± 0.3	45.0 ± 1.0
AP-3x8x35	3.0 ± 0.3	8.0 ± 0.3	35.0 ± 1.0
AP-4x8x45	4.0 ± 0.3	8.0 ± 0.3	45.0 ± 1.0
AP-4x10x50	4.0 ± 0.3	10.0 ± 0.3	50.0 ± 1.0
AP-4x12x60	4.0 ± 0.3	12.0 ± 0.3	60.0 ± 1.0
AP-5x8x50	5.0 ± 0.3	8.0 ± 0.3	50.0 ± 1.0
AP-5x13x80	5.0 ± 0.3	13.0 ± 0.3	80.0 ± 1.2
AP-6x10x42	6.0 ± 0.3	10.0 ± 0.3	42.0 ± 1.0
AP-6x12x53	6.0 ± 0.3	12.0 ± 0.3	53.0 ± 1.0

CORES	A	B	L
AR-8x50	8.0 ± 0.3	7.0 ± 0.3	50.0 ± 1.0
AR-8x60	8.0 ± 0.3	7.0 ± 0.3	60.0 ± 1.0
AR-8x80	8.0 ± 0.3	7.0 ± 0.3	80.0 ± 1.0
AR-8x100	8.0 ± 0.3	7.0 ± 0.3	100.0 ± 1.0
AR-8x140	8.0 ± 0.3	7.0 ± 0.3	140.0 ± 1.0
AR-9.5x57	9.5 ± 0.3	8.5 ± 0.3	57.0 ± 1.0
AR-10x21	10.0 ± 0.3	9.0 ± 0.3	21.0 ± 1.0
AR-10x30	10.0 ± 0.3	9.0 ± 0.3	30.0 ± 1.0
AR-10x50	10.0 ± 0.3	9.0 ± 0.3	50.0 ± 1.0
AR-10x60	10.0 ± 0.3	9.0 ± 0.3	60.0 ± 1.0
AR-10x100	10.0 ± 0.3	9.0 ± 0.3	100.0 ± 1.2
AR-10x120	10.0 ± 0.3	9.0 ± 0.3	120.0 ± 1.0
AR-10x200	10.0 ± 0.3	9.0 ± 0.3	200.0 ± 1.0

1. Material:

A-5 B-15 B-18

2. Ordering Code:

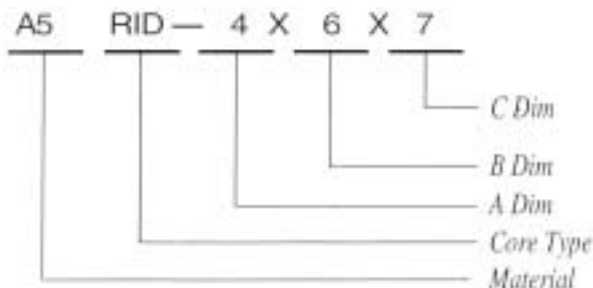

3. Shape:

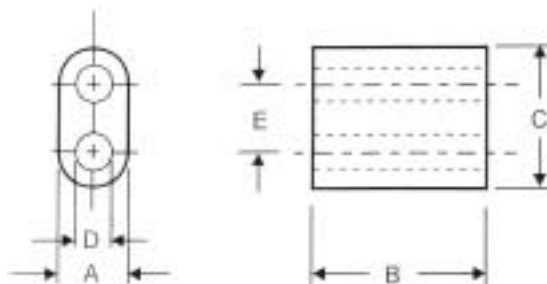

4. Dimensions: (m/m)

CORES	A	B	C	ØD
RID 1.9x1.45x3.35	1.9 ± 0.2	1.45 ± 0.15	3.35 ± 0.2	0.76 ± 0.15
RID 2.6x4x5.3	2.6 ± 0.2	4.0 ± 0.2	5.3 ± 0.2	1.0 ± 0.15
RID 3x2x5	3.0 ± 0.2	2.0 ± 0.2	5.0 ± 0.2	1.2 ± 0.15
RID 3x5x5	3.0 ± 0.2	5.0 ± 0.3	5.0 ± 0.2	1.2 ± 0.15
RID 3.5x5x6.3	3.5 ± 0.2	5.0 ± 0.3	6.3 ± 0.3	1.8 ± 0.15
RID 4x3.2x7	4.0 ± 0.2	3.2 ± 0.2	7.0 ± 0.3	2.0 ± 0.15
RID 4x6x7	4.0 ± 0.2	6.0 ± 0.3	7.0 ± 0.3	2.0 ± 0.15
RID 6.5x4x12	6.5 ± 0.3	4.0 ± 0.2	12.0 ± 0.4	3.8 ± 0.25
RID 6.8x4x11.8	6.8 ± 0.3	4.0 ± 0.2	11.8 ± 0.4	3.8 ± 0.25
RID 7.5x4x13.5	7.5 ± 0.3	4.0 ± 0.2	13.5 ± 0.5	3.8 ± 0.25
RID 7.5x14x13.5	7.5 ± 0.3	14.0 ± 0.52	13.5 ± 0.5	3.8 ± 0.25
RID 8x7x15	8.0 ± 0.3	7.0 ± 0.3	15.0 ± 0.5	5.0 ± 0.25
RID 8x14x15	8.0 ± 0.3	1.40 ± 0.5	15.0 ± 0.5	5.0 ± 0.25

1. Material:

A3 B-15

2. Ordering Code:

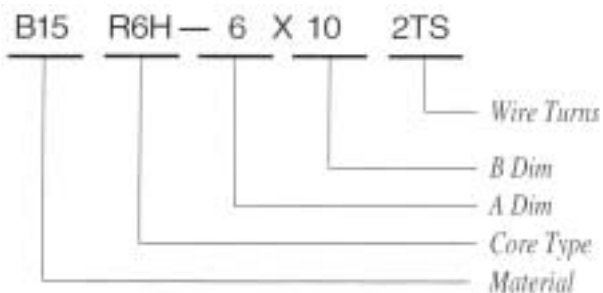

3. Core Shape:

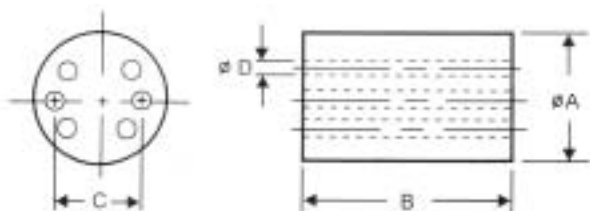

4. Dimensions: (m/m)

A	6.0 ± 0.2
B	10.0 ± 0.4
C	3.4 ± 0.15
D	0.85 ± 0.1

5. Impedance (Ω)

Impedance is measured on AC & B-15 material with the HP-4193A test meter.



Fig.1



Fig.2



Fig.3

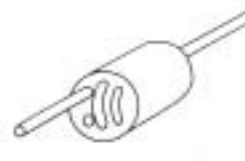

Fig.4



Fig.5

Fig.	TURNS	A3			B-15		
		10MHz	50MHz	100MHz	10MHz	50MHz	100MHz
1	1 ½	130	320	450	180	350	380
2	2 X 1 ½	130	320	450	180	350	380
3	2	200	520	580	260	500	480
4	2 ½	250	750	700	360	700	580
5	3	320	900	700	450	800	580

1. Material:

B-8

2. Ordering Code:

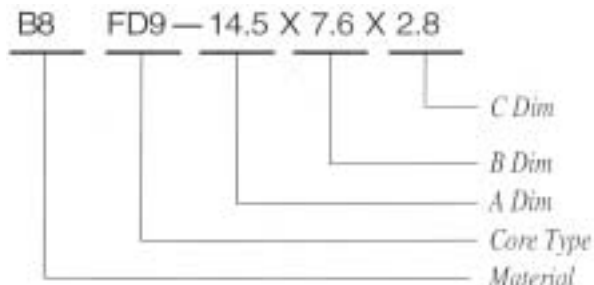

3. Core Shape:



4. Dimensions: (m/m)

CORES	A	B	C	D	E	F	MIN. IMPEDANCE (OHM)	
							25MHz	100MHz
FH-15.4x4.35x8.4	14.5 ± 0.5	7.6 ± 0.5	2.8 ± 0.1	2.74 ± 0.08	2.84 ± 0.08	1.57 <sup>+0.15</sup> <sub>-0</sub>	20	50
FH-20x5.1x9.9	22.65 ± 0.5	7.6 ± 0.5	2.8 ± 0.1	2.77 ± 0.08	2.84 ± 0.08	1.57 <sup>+0.15</sup> <sub>-0</sub>	20	50
FH-29.2x7.7x14.4	36.4 ± 0.5	7.6 ± 0.5	2.8 ± 0.1	2.77 ± 0.08	2.84 ± 0.08	1.57 <sup>+0.15</sup> <sub>-0</sub>	20	50
FH-33.3x8.25x16.4	53.08 ± 0.5	7.7 ± 0.5	2.8 ± 0.1	2.77 ± 0.08	2.84 ± 0.08	1.57 <sup>+0.15</sup> <sub>-0</sub>	20	50
FH-24x12x14	13.6 ± 0.5	9.5 ± 0.3	2.2 ± 0.1	2.27 ± 0.08	2.54 ± 0.15	1.0 <sup>+0.15</sup> <sub>-0</sub>	18	45
FH-28.5x7.5x15	22.6 ± 0.4	9.5 ± 0.3	2.2 ± 0.1	2.29 ± 0.15	2.54 ± 0.15	1.0 <sup>+0.15</sup> <sub>-0</sub>	18	45
FH-30x9.4x18.7	36.6 ± 0.3	9.5 ± 0.3	2.2 ± 0.1	2.29 ± 0.15	2.54 ± 0.15	1.0 <sup>+0.15</sup> <sub>-0</sub>	18	45

5. Typical Performance Data:

- B8FH- 15.4 x 4.35 x 8.4

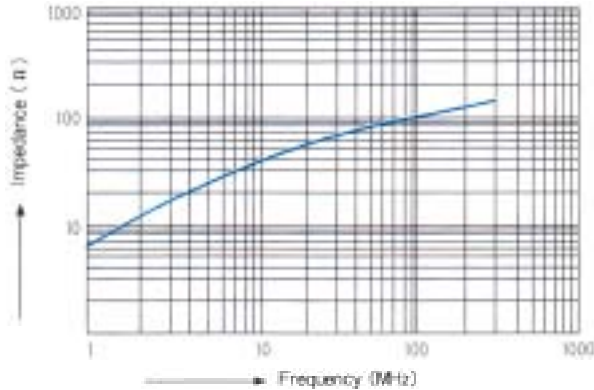

TEST WIRE: 2 UEW 0.8 X 220mm 1/2 Ts  
TEST METER: HP4191A

- B8FH- 28.5 x 7.5 x 15

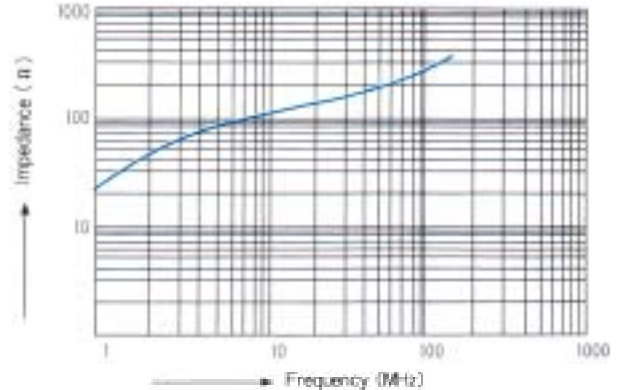

TEST WIRE: 2 UEW 0.8 X 220mm 1/2 Ts  
TEST METER: HP4191A

- B8FH- 20 x 5.1 x 9.9

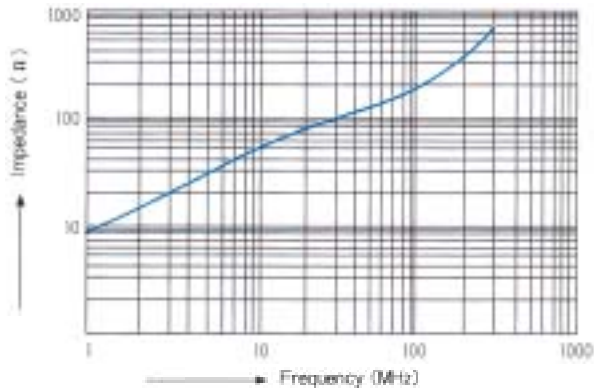

TEST WIRE: 2 UEW 0.8 X 220mm 1/2 Ts  
TEST METER: HP4191A

- B8FH- 30 x 9.4 x 18.7

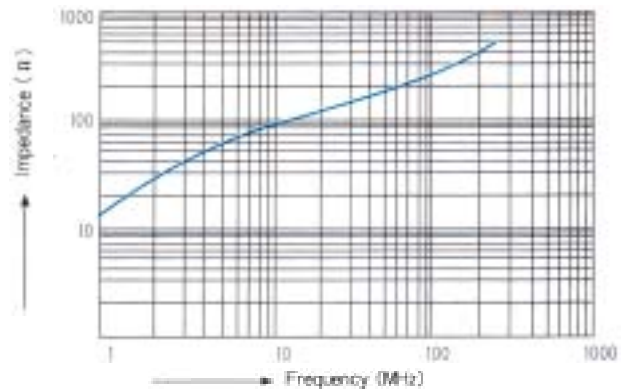

TEST WIRE: 2 UEW 0.8 X 220mm 1/2 Ts  
TEST METER: HP4191A

- B8FH- 24 x 12 x 14

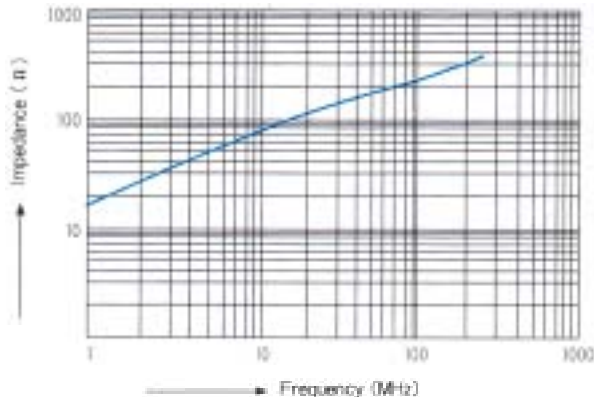

TEST WIRE: 2 UEW 0.8 X 220mm 1/2 Ts  
TEST METER: HP4191A

- B8FH- 29.7 x 13 x 25.9

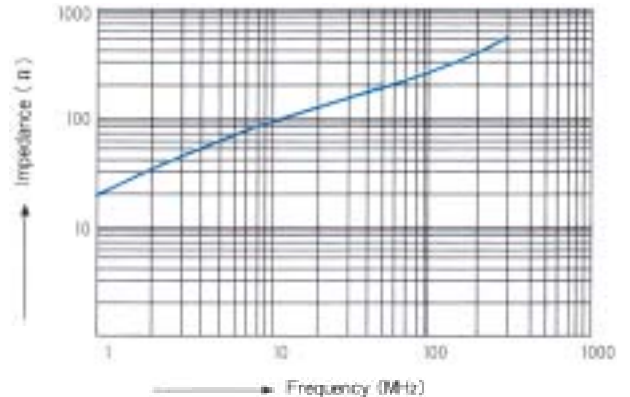

TEST WIRE: 2 UEW 0.8 X 220mm 1/2 Ts  
TEST METER: HP4191A



1. Material:

B-8

2. Ordering Code:

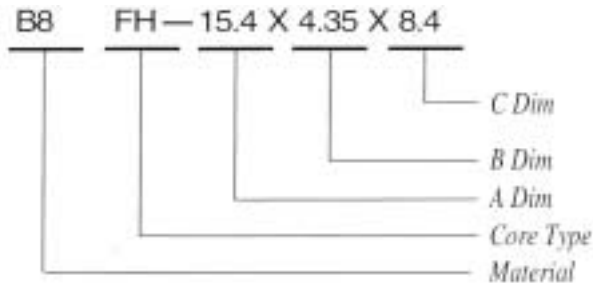

3. Core Shape:

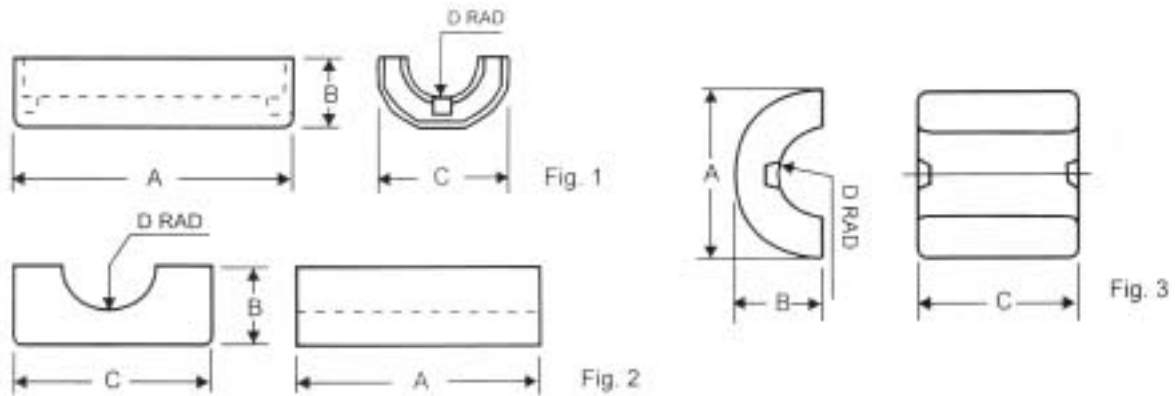

4. Dimensions: (m/m)

CORES	A	B	C	D	Fig.	MIN. IMPEDANCE (OHM)	
						25MHz	100MHz
FH-15.4x4.35x8.4	15.4 ± 0.5	4.35 ± 0.3	8.4 ± 0.4	1.9 ± 0.15	1	50	80
FH-20x5.1x9.9	20.0 ± 0.5	5.1 ± 0.3	9.9 ± 0.4	2.65 ± 0.15	1	70	140
FH-29.2x7.7x14.4	29.2 ± 0.5	7.6 ~ 7.8	14.4 ± 0.5	3.8 ± 0.15	1	100	180
FH-33.3x8.25x16.4	33.3 ± 0.6	8.2 ~ 8.4	16.4 ± 0.5	4.65 ± 0.15	1	105	190
FH-24x12x14	24.0 ± 0.6	12.0 ± 0.4	14.0 ± 0.5	5.7 ± 0.3	3	50	100
FH-28.5x7.5x15	28.5 ± 0.75	7.5 ± 0.3	15.0 ± 0.5	3.3 ± 0.15	2	130	200
FH-30x9.4x18.7	30.0 ± 0.75	9.4 ± 0.3	18.7 ± 0.7	5.1 ± 0.15	2	105	180
FH-29.7x13x25.9	29.7 ± 0.75	13.0 ± 0.3	25.9 ± 0.7	6.5 ± 0.15	2	120	200

4. Typical Performance Date: (Cont.)

- FP- 49.6 x125 x 6.5

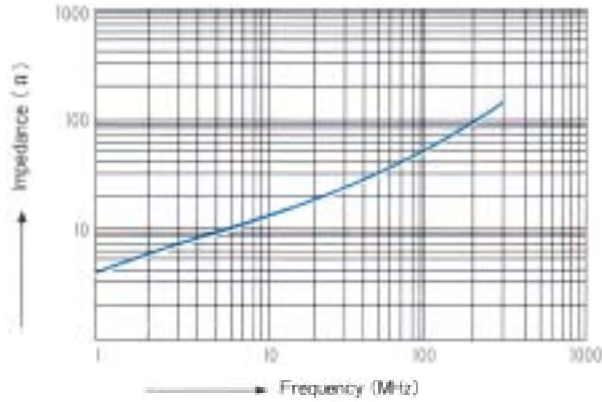

TEST WIRE: 2 UEW 0.8 X 220mm 1/2 Ts  
TEST METER: HP4191A

- FI- 63.5 x 28.5 x 6.35

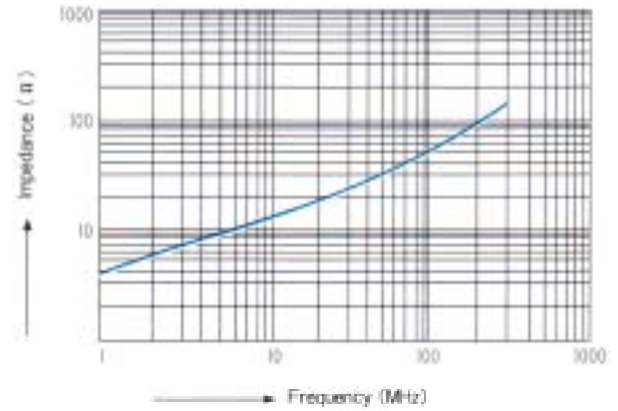

TEST WIRE: 2 UEW 0.8 X 220mm 1/2 Ts  
TEST METER: HP4191A

5. Dimensions: (m/m)

CORES	A	B	C	D	E	Fig.	MIN. IMPEDANCE (OHM)	
							25MHz	100MHz
FP-16x12x4.5	16.0 ± 0.5	12.0 ± 0.4	4.5 ± 0.3	11.5 ± 0.3	0.85 ± 0.15	1	20	50
FP-23.5x15x6.3	23.5 ± 0.8	15.0 ± 0.5	6.3 ± 0.4	19.0 ± 0.5	1.0 ± 0.2	1	20	50
FP-25x12x5	25.0 ± 0.8	12.0 ± 0.4	5.0 ± 0.3	21.0 ± 0.5	0.85 ± 0.15	1	20	50
FP-32x9.5x6.5	32.0 ± 0.8	9.5 ± 0.3	6.5 ± 0.4	28.0 ± 0.8	2.8 ± 0.42	1	15	45
FP-33x11.5x7.5	33.0 ± 0.8	11.5 ± 0.3	7.5 ± 0.4	28.0 ± 0.8	2.8 ± 0.2	1	25	60
FP-33x15x8.45	33.0 ± 0.8	15.0 ± 0.5	8.45 ± 0.4	28.0 ± 0.8	3.5 ± 0.3	1	25	60
FP-33.5x12x6.5	33.5 ± 1.0	12.0 ± 0.3	6.5 ± 0.4	27.0 ± 0.7	1.5 ± 0.2	1	20	40
FP-x12x6.540	40.0 ± 1.0	12.0 ± 0.3	6.5 ± 0.4	34.8 ± 0.8	1.3 ± 0.2	1	15	35
FP-45.2x12x6.5	45.2 ± 1.0	12.0 ± 0.3	6.5 ± 0.4	40.0 ± 0.8	1.3 ± 0.2	1	15	35
FP-46.5x10x6.5	46.5 ± 1.0	10.0 ± 0.3	6.5 ± 0.4	40.0 ± 0.8	1.3 ± 0.2	1	25	60
FP-49.6x12x6.5	49.6 ± 1.0	12.0 ± 0.3	6.5 ± 0.4	44.0 ± 0.8	1.3 ± 0.2	1	15	35
FP-57.6x12x6.5	57.6 ± 1.0	12.0 ± 0.3	6.5 ± 0.4	52.0 ± 0.8	1.5 ± 0.2	1	15	40
FPL-28x14.6x7.7	28 ± 1.0	14.6 ± 0.5	7.7 ± 0.4	23.0 ± 0.5	1.5 ± 0.3	2	30	75
FI-45.1x28.5x4.5	45.1 ± 1.0	28.5 ± 0.8	4.5 ± 0.5	34.4 ± 0.8	0.6 ± 0.2	3	45	80
FI-45.1x28.5x6.35	45.1 ± 1.0	28.5 ± 0.8	6.35 ± 0.5	34.4 ± 0.8	0.8 ± 0.2	3	50	90
FI-63.5x28.5x6.35	36.5 ± 1.5	28.5 ± 0.8	6.35 ± 0.5	52.1 ± 1.5	0.8 ± 0.2	3	40	80
FI-76.2x28.5x6.4	76.2 ± 1.5	28.5 ± 0.8	6.40 ± 0.5	65.3 ± 1.5	0.8 ± 0.2	3	65	150



1. Material:

B-8 B-15

2. Ordering Code:

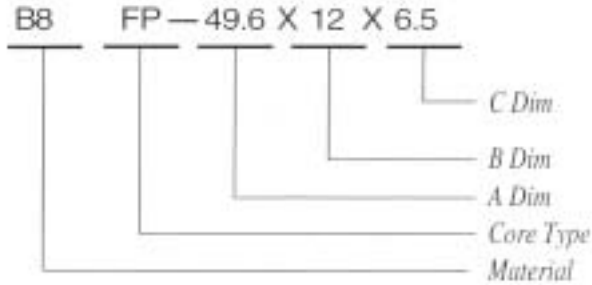

3. Core Shape:

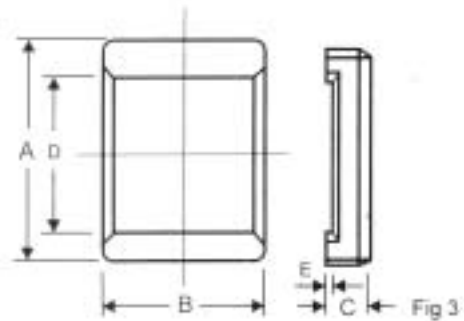
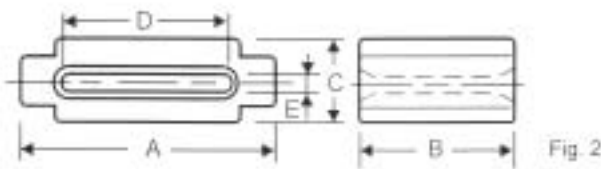
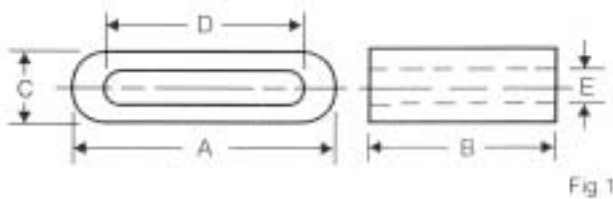

4. Typical Performance Date:

- FP- 33 x 11.5 x 7.5

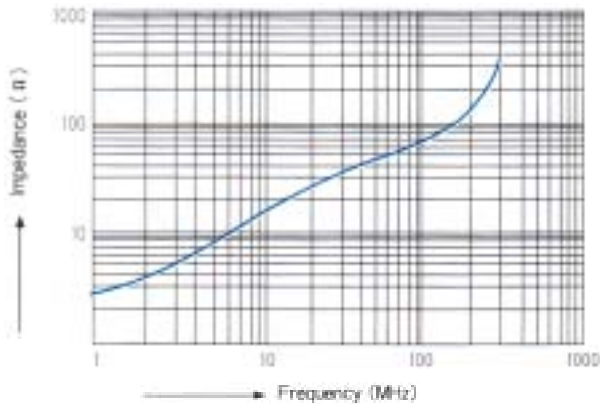

TEST WIRE: 2 UEW .65 X 160mm 1/2 Ts  
TEST METER: HP4191A

- FP- 45.2 x 12 x 6.5

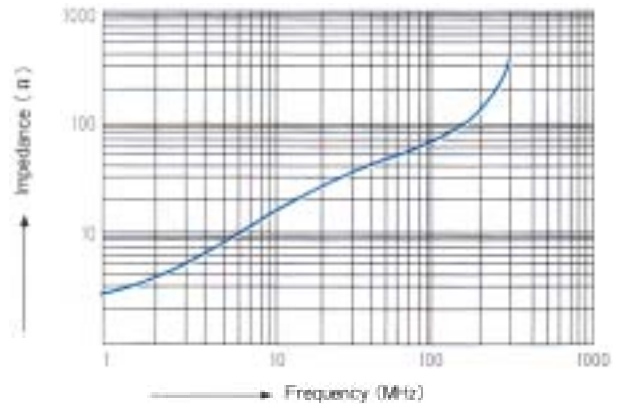

TEST WIRE: 2 UEW 0.8 X 220mm 1/2 Ts  
TEST METER: HP4191A

- B15T- 18.3 x 10 x 10

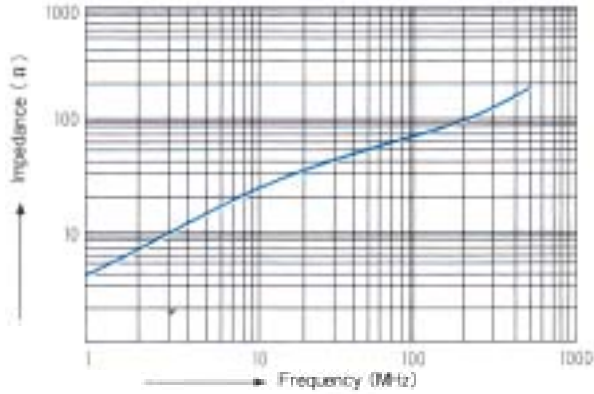

TEST WIRE: 2 UEW 1.0 X 63mm 1/2 Ts  
TEST METER: HP4191A

- B15T- 20.5 x 10 x 10.3

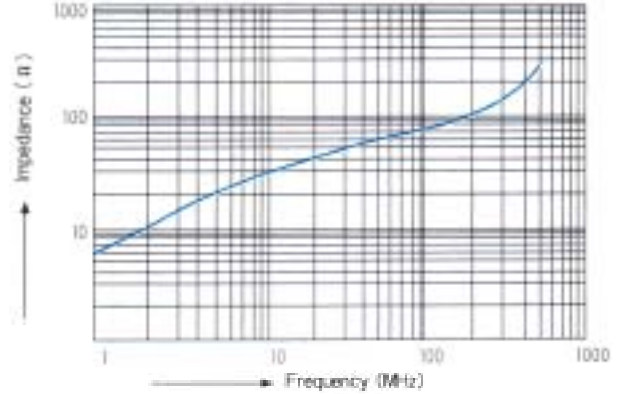

TEST WIRE: 2 UEW 1.0 X 63mm 1/2 Ts  
TEST METER: HP4191A

- B8T- 22.5 x 6.4 x 13.8

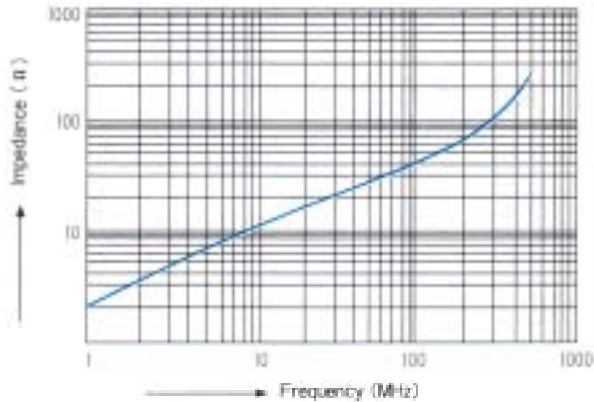

TEST WIRE: 2 UEW 1.0 X 63mm 1/2 Ts  
TEST METER: HP4191A

- B8T- 25 x 12 x 15

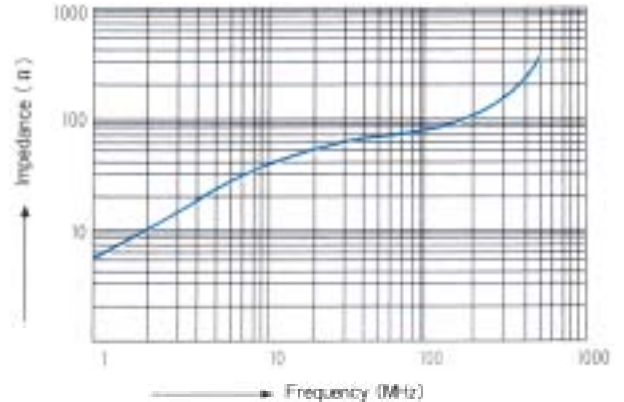

TEST WIRE: 2 UEW 1.0 X 63mm 1/2 Ts  
TEST METER: HP4191A

- B8T- 28 x 7.5 x 16

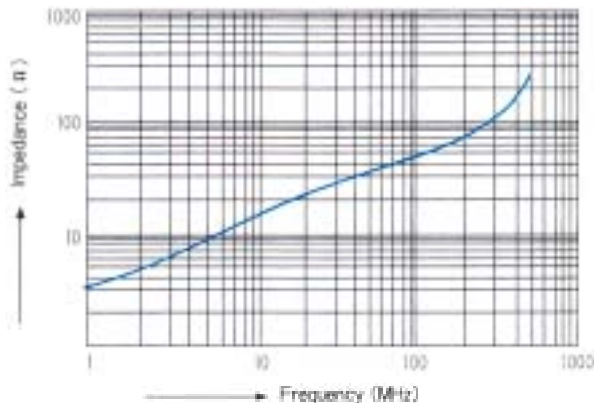

TEST WIRE: 2 UEW 1.0 X 63mm 1/2 Ts  
TEST METER: HP4191A

- B8T- 31 x 8 x 19

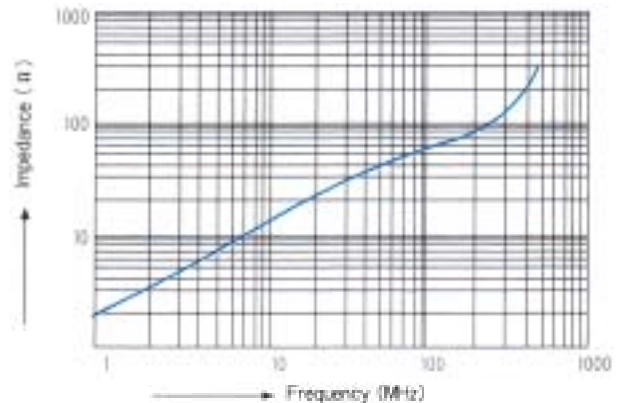

TEST WIRE: 2 UEW 1.0 X 63mm 1/2 Ts  
TEST METER: HP4191A

5. Typical Performance Data:

- B15T- 8 x 4 x 4

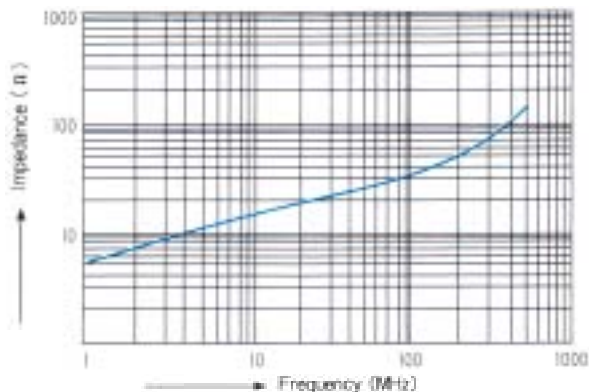

TEST WIRE: 2 UEW 1.0 X 63mm 1/2 Ts  
TEST METER: HP4191A

- B15T- 9.5 x 4.5 x 4.75

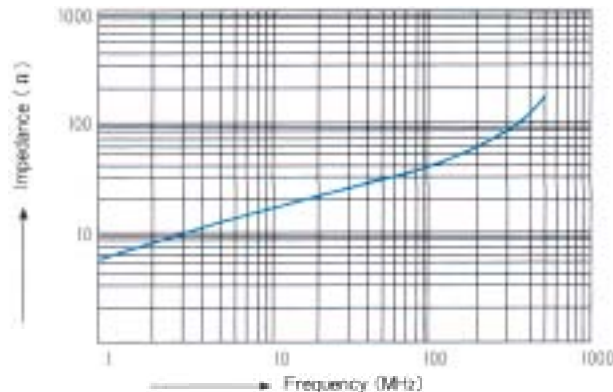

TEST WIRE: 2 UEW 1.0 X 63mm 1/2 Ts  
TEST METER: HP4191A

- B15T- 12 x 5.5 x 7

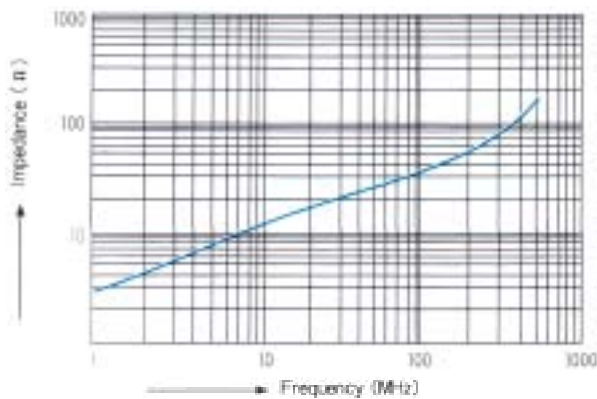

TEST WIRE: 2 UEW 1.0 X 63mm 1/2 Ts  
TEST METER: HP4191A

- B15T- 12.7 x 6.35 x 7.93

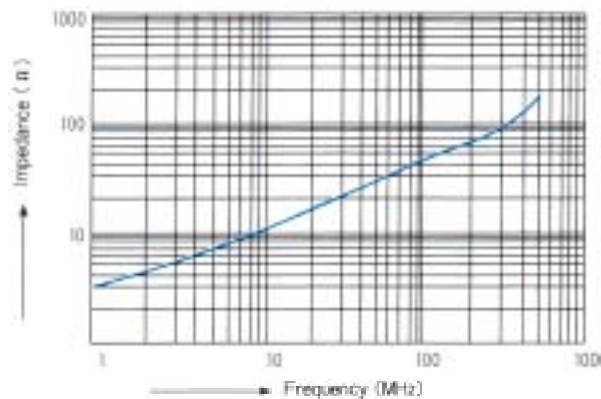

TEST WIRE: 2 UEW 1.0 X 63mm 1/2 Ts  
TEST METER: HP4191A

- B15T- 16.2 x 7.5 x 9.1

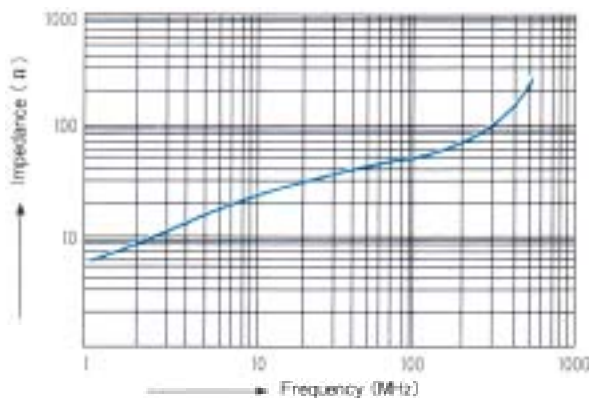

TEST WIRE: 2 UEW 1.0 X 63mm 1/2 Ts  
TEST METER: HP4191A

- B15T- 17.5 x 12.7 x 9.5

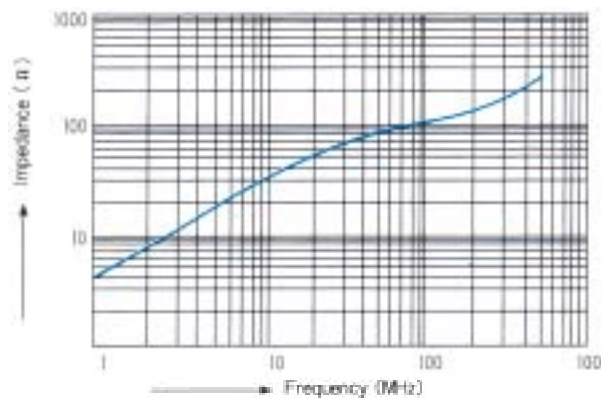

TEST WIRE: 2 UEW 1.0 X 63mm 1/2 Ts  
TEST METER: HP4191A

CORES	A	B	C	MIN. IMPEDANCE (OHM)	
				25MHz	100MHz
B15 T12.1x11x8.6	12.1 ± 0.4	11.0 ± 0.3	8.6 ± 0.3	30	63
B15 T12.7x6.35x7.93	12.7 ± 0.4	6.35 ± 0.3	7.93 ± 0.3	25	60
B15 T13x8x8.2	13.0 ± 0.4	8.0 ± 0.3	8.2 ± 0.3	28	60
B15 T13.5x4x7	13.5 ± 0.4	4.0 ± 0.25	7.0 ± 0.3	22	58
B15 T13.5x5x7	13.5 ± 0.4	5.0 ± 0.3	7.0 ± 0.3	25	60
B8 T14.2x7x7	14.2 ± 0.4	7.0 ± 0.3	7.0 ± 0.3	25	55
B8 T16x8x9.8	16.0 ± 0.4	8.0 ± 0.3	9.8 ± 0.3	25	55
B8 T16x8x12	16.0 ± 0.4	8.0 ± 0.3	12.0 ± 0.4	22	50
B15 T16x10x10	16.0 ± 0.4	10.0 ± 0.3	10.0 ± 0.3	33	65
B15 T16.2x4.8x9.1	16.2 ± 0.4	4.8 ± 0.3	9.1 ± 0.3	22	58
B15 T16.2x7.5x9.1	16.2 ± 0.4	7.5 ± 0.3	9.1 ± 0.3	30	65
B15 T17.5x5x9.5	17.5 ± 0.5	5.0 ± 0.3	9.5 ± 0.3	23	58
B15 T17.5x6.4x9.5	17.5 ± 0.5	6.4 ± 0.3	9.5 ± 0.3	28	63
B30 T17.5x8x9.5	17.5 ± 0.5	8.0 ± 0.3	9.5 ± 0.3	30	60
B8 T17.5x12.7x9.5	17.5 ± 0.5	12.7 ± 0.4	9.5 ± 0.3	40	80
B15 T17.5x13.5x9.5	17.5 ± 0.5	13.5 ± 0.4	9.5 ± 0.3	45	86
B15 T17.5x15x9.5	17.5 ± 0.5	15.0 ± 0.4	9.5 ± 0.3	55	92
B15 T18.3x7x10	18.3 ± 0.5	7.0 ± 0.3	10.0 ± 0.3	30	65
B15 T18.3x10x10	18.3 ± 0.5	10.0 ± 0.3	10.0 ± 0.3	40	75
B15 T18.4x6.2x11	18.4 ± 0.5	6.2 ± 0.3	11.0 ± 0.3	25	60
B15 T18.4x12.5x9.5	18.4 ± 0.5	12.5 ± 0.4	9.5 ± 0.3	50	88
B15 T20.5x5x10.3	20.5 ± 0.5	5.0 ± 0.3	10.0 ± 0.3	25	60
B15 T20.5x8x10.3	20.5 ± 0.5	8.0 ± 0.3	10.3 ± 0.3	40	75
B15 T20.5x10x10.3	20.5 ± 0.5	10.0 ± 0.3	10.3 ± 0.3	40	80
B8 T22.5x6.4x13.8	22.5 ± 0.5	6.4 ± 0.3	13.8 ± 0.4	20	55
B15 T22.5x8.5x13.8	22.5 ± 0.5	8.5 ± 0.3	13.8 ± 0.4	30	65
B15 T22.5x13.5x13.8	22.5 ± 0.5	13.5 ± 0.4	13.8 ± 0.4	40	85
B15 T23x9.5x12.5	23.0 ± 0.5	9.5 ± 0.3	12.5 ± 0.4	40	75
B8 T25x12x15	25.0 ± 0.6	12.0 ± 0.4	15.0 ± 0.4	40	80
B30 T26x8x16	26.0 ± 0.6	8.0 ± 0.3	16.0 ± 0.4	26	60
B15 T28x20x13.8	28.0 ± 0.7	20.0 ± 0.5	13.8 ± 0.4	85	135
B15 T28x7.5x16	28.0 ± 0.7	7.5 ± 0.3	16.0 ± 0.4	30	65
B15 T29x14x19	29.0 ± 0.7	14.0 ± 0.4	19.0 ± 0.5	40	80
B15 T31x7x19	31.0 ± 0.8	7.0 ± 0.3	19.0 ± 0.5	25	63
B15 T31x8x19	31.0 ± 0.8	8.0 ± 0.3	19.0 ± 0.5	28	65
B15 T47x14x29.5	47.0 ± 1.0	14.0 ± 0.5	29.5 ± 0.6	46	90



1. Material:

B-8 B-10 B-12 B-15 B-30

2. Ordering Code:

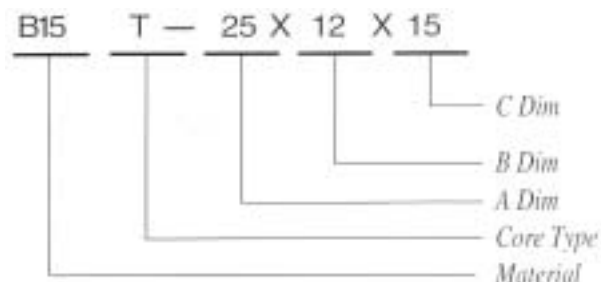

3. Core Shape:

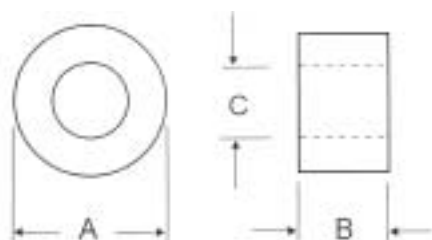

4. Dimensions: (m/m)

CORES	A	B	C	MIN. IMPEDANCE (OHM)	
				25MHz	100MHz
B15 T4x1.5x2	4.0 ± 0.25	1.5 ± 0.2	2.0 ± 0.2	12	30
B15 T6x2x3	6.0 ± 0.3	2.0 ± 0.2	3.0 ± 0.25	15	40
B15 T7.75x4.25x3.8	7.75 ± 0.3	4.25 ± 0.25	3.8 ± 0.25	20	55
B15 T8x4x4	8.0 ± 0.3	4.0 ± 0.25	4.0 ± 0.25	20	55
B15 T9.3x3.2x6.3	9.3 ± 0.3	3.2 ± 0.25	6.3 ± 0.3	18	50
B15 T9.5x4.5x4.75	9.5 ± 0.3	4.5 ± 0.3	4.75 ± 0.3	20	55
B30 T9.66x3.3x5	9.66 ± 0.3	3.3 ± 0.25	5.0 ± 0.3	17	50
B15 T9.66x5.8x6.35	9.66 ± 0.3	5.8 ± 0.3	6.35 ± 0.3	20	50
B15 T10x5x5.1	10.0 ± 0.3	5.0 ± 0.3	5.1 ± 0.3	25	60
B15 T10x4x6	10.0 ± 0.3	4.0 ± 0.25	6.0 ± 0.3	20	55
B15 T10x5x7	10.0 ± 0.3	5.0 ± 0.3	7.0 ± 0.3	18	55
B15 T11x9x5	11.0 ± 0.4	9.0 ± 0.3	5.0 ± 0.3	40	75
B15 T11.8x8x7.3	11.8 ± 0.4	8.0 ± 0.3	7.3 ± 0.3	30	60
B15 T12x4x6	12.0 ± 0.4	4.0 ± 0.25	6.0 ± 0.3	22	58
B15 T12x6x6	12.0 ± 0.4	6.0 ± 0.3	6.0 ± 0.3	28	60
B8 T12x5.5x7	12.0 ± 0.4	5.5 ± 0.3	7.0 ± 0.3	22	60
B15 T12.1x8x8.6	12.1 ± 0.4	8.0 ± 0.3	8.6 ± 0.3	22	58

• B8RH- 14.3 x 28.5 x 6.35

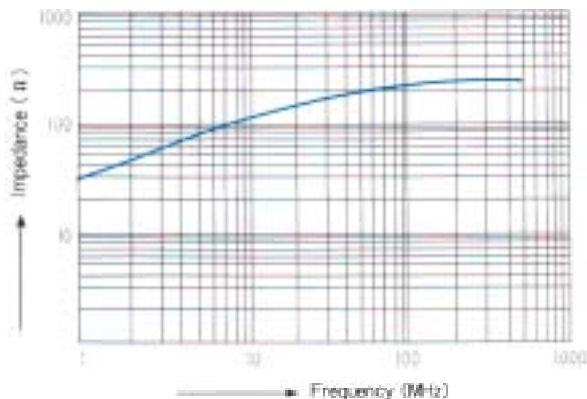

TEST WIRE: 2 UEW 1.0 X 63mm 1/2 Ts  
TEST METER: HP4191A

• B15RH- 16 x 28 x 9

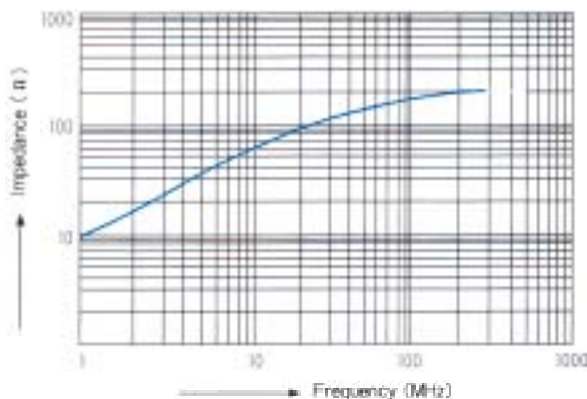

TEST WIRE: 2 UEW 1.0 X 63mm 1/2 Ts  
TEST METER: HP4191A

• B8RH- 14.3 x 28.5 x 7

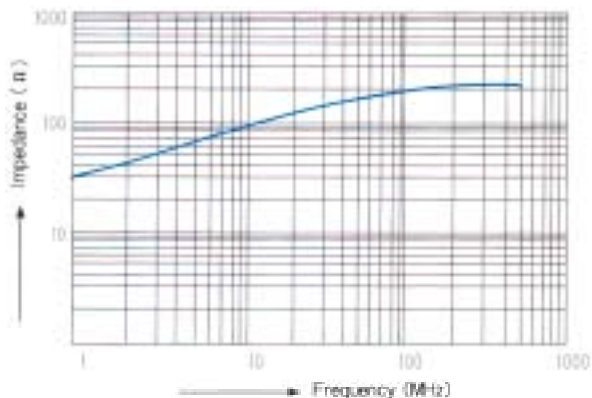

TEST WIRE: 2 UEW 1.0 X 63mm 1/2 Ts  
TEST METER: HP4191A

• B8RH- 17.5 x 28.5 x 9.5

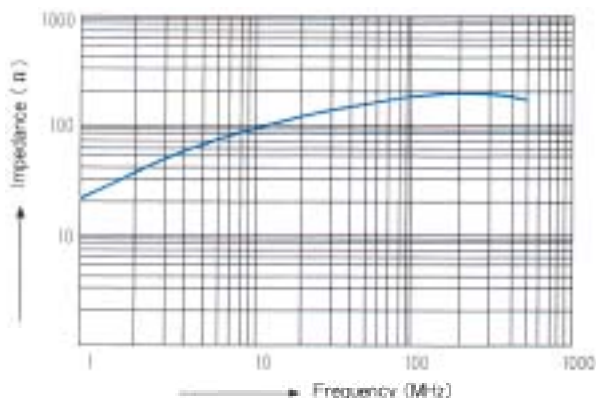

TEST WIRE: 2 UEW 1.0 X 63mm 1/2 Ts  
TEST METER: HP4191A

• B15RH- 16 x 17 x 9

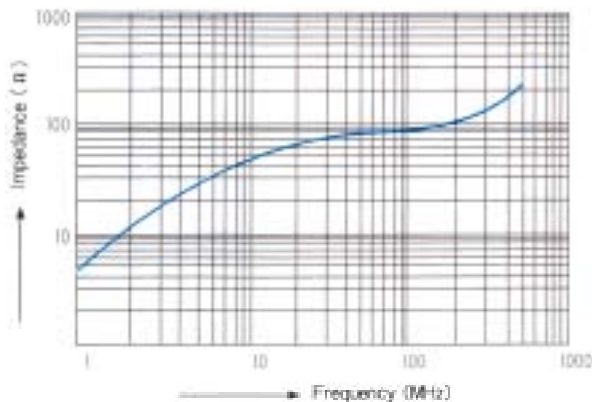

TEST WIRE: 2 UEW 1.0 X 63mm 1/2 Ts  
TEST METER: HP4191A

• B8RH- 28.3 x 28.5 x 13.8

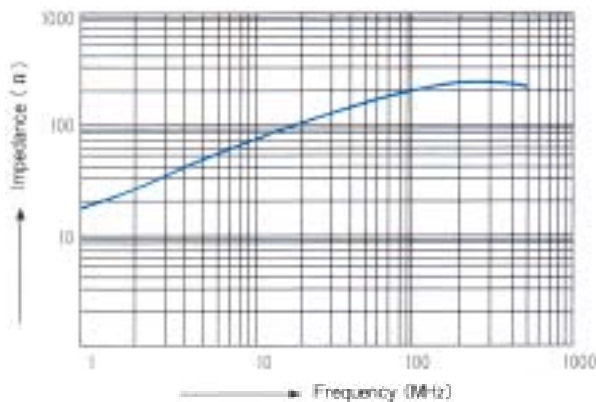

TEST WIRE: 2 UEW 1.0 X 63mm 1/2 Ts  
TEST METER: HP4191A



5. Typical Performance Data

- B15RH- 3.5 x 4.7 x 0.8

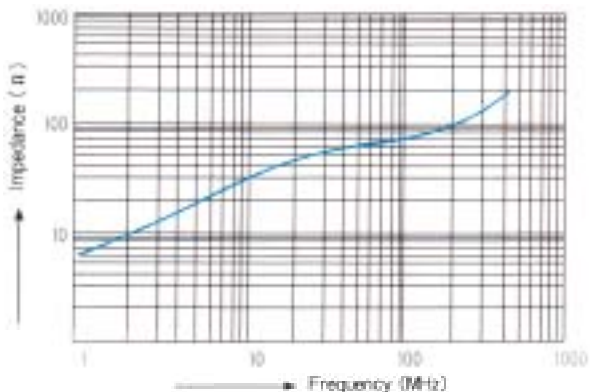

TEST WIRE: 2 UEW 0.4 X 63mm 1/2 Ts  
TEST METER: HP4191A

- B8RH- 12 x 15 x 7.3

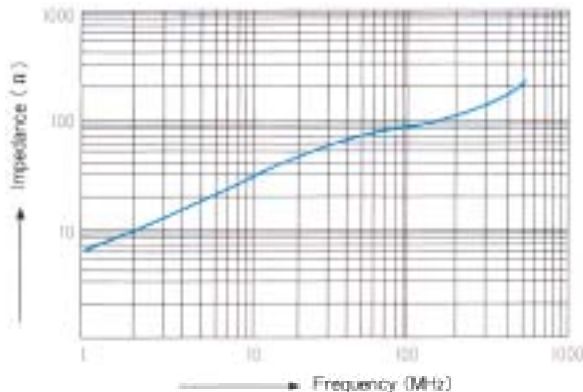

TEST WIRE: 2 UEW 1.0 X 63mm 1/2 Ts  
TEST METER: HP4191A

- B15RH- 6 x 10 x 3

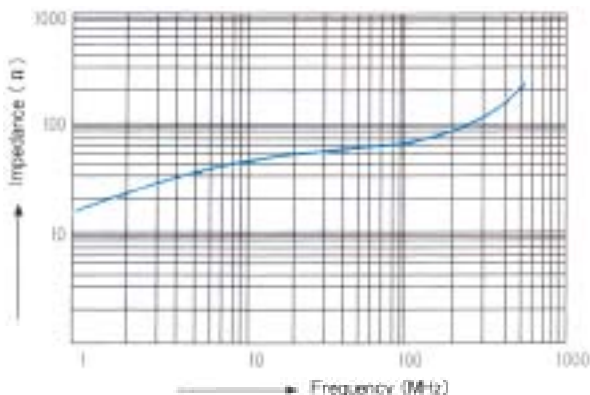

TEST WIRE: 2 UEW 1.0 X 63mm 1/2 Ts  
TEST METER: HP4191A

- B15RH- 12 x 20 x 5.6

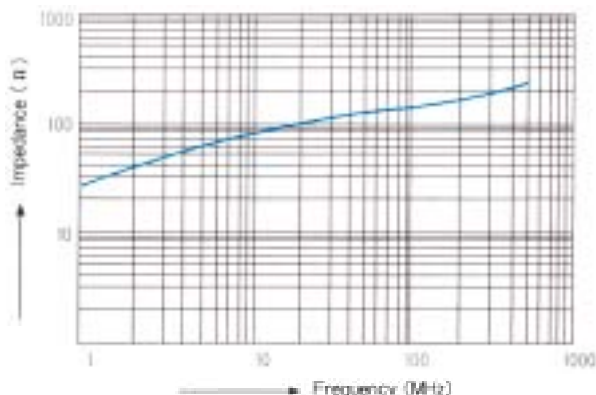

TEST WIRE: 2 UEW 1.0 X 63mm 1/2 Ts  
TEST METER: HP4191A

- B15RH- 9.5 x 10 x 5

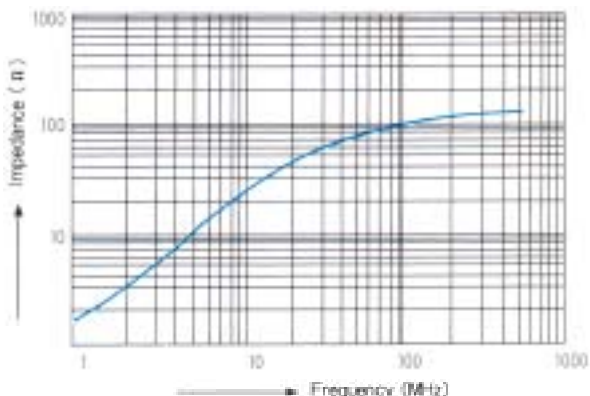

TEST WIRE: 2 UEW 1.0 X 63mm 1/2 Ts  
TEST METER: HP4191A

- B15RH- 14.2 x 23.5 x 7.9

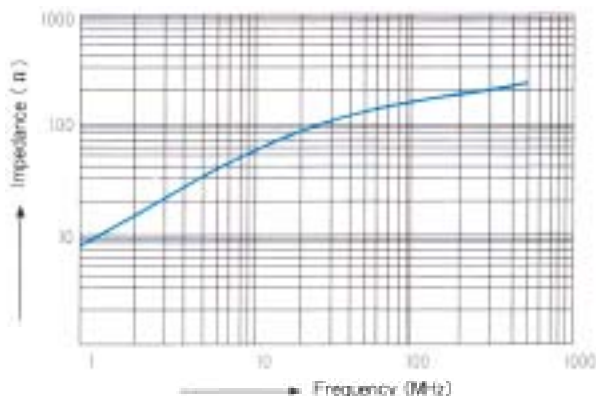

TEST WIRE: 2 UEW 1.0 X 63mm 1/2 Ts  
TEST METER: HP4191A

CORES	A	B	C	MIN. IMPEDANCE (OHM)	
				25MHz	100MHz
B15 RH8x9.2x5	8.0 ± 0.3	9.2 ± 0.3	5.0 ± 0.3	30	60
B15 RH9x16x5	9.0 ± 0.3	16.0 ± 0.5	5.0 ± 0.3	60	100
B15 RH9.5x10x5	9.5 ± 0.3	10.0 ± 0.4	5.0 ± 0.3	42	80
B8 RH9.5x12.7x5	9.5 ± 0.3	12.7 ± 0.4	5.0 ± 0.3	45	88
B15 RH9.66x10.2x6.35	9.66 ± 0.3	10.2 ± 0.4	6.35 ± 0.3	30	63
B15 RH9.8x13.5x6.35	9.8 ± 0.3	13.5 ± 0.4	6.35 ± 0.3	40	75
B15 RH10x10x7	10.0 ± 0.4	10.0 ± 0.4	7.0 ± 0.3	28	60
B15 RH10.3x10.2x5.8	10.3 ± 0.4	10.2 ± 0.4	5.8 ± 0.3	40	75
B15 RH10.5x20x5.5	10.5 ± 0.4	20.0 ± 0.5	5.5 ± 0.3	80	125
B15 RH11.5x19x7.1	11.5 ± 0.4	19.0 ± 0.5	7.1 ± 0.3	60	100
B8 RH12x15x7.3	12.0 ± 0.4	15.0 ± 0.5	7.3 ± 0.15	40	85
B15 RH12x20x5.6	12.0 ± 0.4	20.0 ± 0.6	5.6 ± 0.3	100	160
B15 RH12x25.7x5.5	12.0 ± 0.4	25.7 ± 0.7	5.5 ± 0.3	130	180
B15 RH12.7x12.7x7.9	12.7 ± 0.4	12.7 ± 0.4	7.9 ± 0.3	45	80
B15 RH12.7x15x7.9	12.7 ± 0.4	15.0 ± 0.5	7.9 ± 0.3	50	85
B15 RH14.2x23.5x7.9	14.2 ± 0.5	13.5 ± 0.7	7.9 ± 0.3	88	140
B15 RH14.3x15x6.35	14.3 ± 0.5	15.0 ± 0.5	6.35 ± 0.3	70	120
B15 RH14.3x28.5x6.35	14.3 ± 0.5	28.5 ± 0.7	6.35 ± 0.3	130	190
B8 RH14.3x28.5x7	14.3 ± 0.5	28.5 ± 0.7	7.0 ± 0.3	130	180
B8 RH15.5x28.5x7.3	15.5 ± 0.5	28.5 ± 0.7	7.3 ± 0.3	130	180
B15 RH16x16x7.9	16.0 ± 0.5	16.0 ± 0.5	7.9 ± 0.3	70	110
B8 RH16x17x9	16.0 ± 0.5	17.0 ± 0.5	9.0 ± 0.4	60	100
B8 RH16x28x9	16.0 ± 0.5	28.0 ± 0.7	9.0 ± 0.4	90	160
B15 RH16x28x9.8	16.0 ± 0.5	28.0 ± 0.7	9.8 ± 0.4	88	140
B8 RH17.5x28.5x9.5	17.5 ± 0.5	28.5 ± 0.7	9.5 ± 0.4	100	150
B15 RH17.5x28.5x9.9	17.5 ± 0.5	28.5 ± 0.7	9.9 ± 0.4	100	150
B15 RH17.5x28.5x11	17.5 ± 0.5	28.5 ± 0.7	11.0 ± 0.5	90	135
B15 RH17.5x28.5x12.8	17.5 ± 0.5	28.5 ± 0.7	12.8 ± 0.5	65	100
B15 RH18.4x28.5x9.5	18.4 ± 0.5	28.5 ± 0.7	9.5 ± 0.4	120	180
B15 RH18.4x28.5x10.2	8.4 ± 0.5	28.5 ± 0.7	10.2 ± 0.4	110	160
B15 RH18.4x28.5x11	18.4 ± 0.5	28.5 ± 0.7	11.0 ± 0.5	100	150
B15 RH19.7x28.5x11.5	19.7 ± 0.5	28.5 ± 0.7	13.8 ± 0.6	100	145
B8 RH28.3x28.5x13.8	28.3 ± 0.7	28.5 ± 0.7	13.8 ± 0.6	116	200



1. Material:

B-8 B-10 B-12 B-15 B-30

2. Ordering Code:

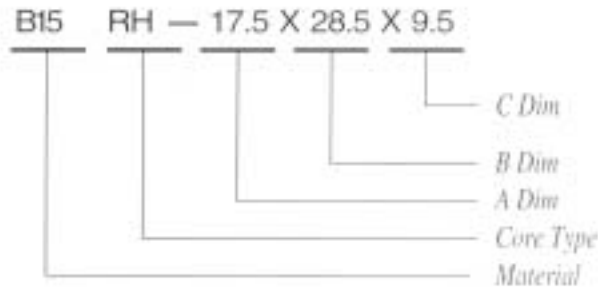

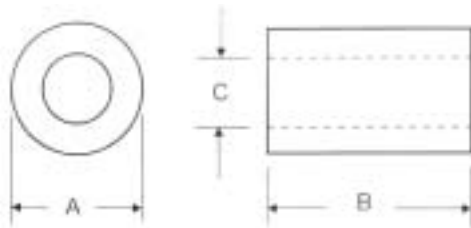

3. Core Shape:



4. Dimensions: (m/m)

CORES	A	B	C	MIN. IMPEDANCE (OHM)	
				25MHz	100MHz
B15 RH3.5x3.5x0.8	3.5 ± 0.2	3.5 ± 0.2	0.8 ± 0.15	25	45
B15 RH3.5x4.7x0.8	3.5 ± 0.2	3.5 ± 0.2	3.5 ± 0.2	30	50
B15 RH3.5x4x1.2	3.5 ± 0.2	3.5 ± 0.2	3.5 ± 0.2	25	50
B15 RH3.5x6x1.2	3.5 ± 0.2	3.5 ± 0.2	3.5 ± 0.2	30	55
B8 RH3.5x3x1.35	3.5 ± 0.2	3.5 ± 0.2	3.5 ± 0.2	15	35
B8 RH3.5x5x1.5	3.5 ± 0.2	3.5 ± 0.2	3.5 ± 0.2	18	35
B15 RH4x10x2	3.5 ± 0.2	3.5 ± 0.2	3.5 ± 0.2	30	55
B15 RH4.5x5x1.5	3.5 ± 0.2	3.5 ± 0.2	3.5 ± 0.2	30	60
B15 RH5x5x2.6	3.5 ± 0.2	3.5 ± 0.2	3.5 ± 0.2	26	55
B15 RH5x15x1.5	3.5 ± 0.2	3.5 ± 0.2	3.5 ± 0.2	80	140
B15 RH8x8x3.75	3.5 ± 0.2	3.5 ± 0.2	3.5 ± 0.2	30	70
B15 RH6x10x3	3.5 ± 0.2	3.5 ± 0.2	3.5 ± 0.2	48	80
B15 RH7.75x7.75x2.5	3.5 ± 0.2	3.5 ± 0.2	3.5 ± 0.2	56	92
B15 RH7.75x7.75x4	3.5 ± 0.2	3.5 ± 0.2	3.5 ± 0.2	35	65
B15 RH7.75x13x4	3.5 ± 0.2	3.5 ± 0.2	3.5 ± 0.2	56	90

**RELIABILITY AND TEST CONDITIONS**

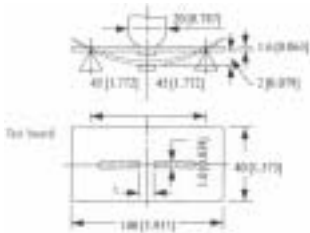
Operating Temperature Range	-25 to +85°C [-40 to +185°F]																						
Storage Temperature Range	-40 to +85°C [-40 to +185°F] 0 to 60°C [32 to 140°F] (In tape and reel packing)																						
Soldering Heat Resistance	The chip shall not crack. More than 75% of the terminal electrode shall be covered with solder.	Preheat: 120 to 150°C [248 to 302°F] for 60 seconds Solder: H63A (eutectic solder) Solder Temperature: 300 ± 5°C [572 ± 9°F] Flux: Rosin Dip time: 10 ± 0.5 seconds																					
Solderability	More than 90% of the terminal electrode shall be covered with new solder	Preheat: 120 to 150°C [248 to 302°F] for 60 seconds Solder: H63A (eutectic solder) Solder Temperature: 230 ± 5°C [572 ± 9°F] Flux: Rosin Dip Time: 3 ± 1 seconds																					
Terminal Strength	The terminal electrode shall not break off nor will the ferrite be damaged.	 <table border="1"> <thead> <tr> <th>Type</th> <th>W(N) [kgf]</th> <th>Time (sec.)</th> </tr> </thead> <tbody> <tr> <td>CB201209</td> <td>5.9[0.6]</td> <td rowspan="6">30 ± 5</td> </tr> <tr> <td>CB321611</td> <td>9.8[1.0]</td> </tr> <tr> <td>CB321616</td> <td>9.8[1.0]</td> </tr> <tr> <td>CB322513</td> <td>9.8[1.0]</td> </tr> <tr> <td>CB451616</td> <td>9.8[1.0]</td> </tr> <tr> <td>CB453215</td> <td>14.7[1.5]</td> </tr> </tbody> </table>	Type	W(N) [kgf]	Time (sec.)	CB201209	5.9[0.6]	30 ± 5	CB321611	9.8[1.0]	CB321616	9.8[1.0]	CB322513	9.8[1.0]	CB451616	9.8[1.0]	CB453215	14.7[1.5]					
Type	W(N) [kgf]	Time (sec.)																					
CB201209	5.9[0.6]	30 ± 5																					
CB321611	9.8[1.0]																						
CB321616	9.8[1.0]																						
CB322513	9.8[1.0]																						
CB451616	9.8[1.0]																						
CB453215	14.7[1.5]																						
Bending Strength	The ferrite shall not be damaged by forces applied on the right.	 <table border="1"> <thead> <tr> <th>Type</th> <th>A(mm) [inches]</th> <th>P(N) [kgf]</th> </tr> </thead> <tbody> <tr> <td>CB201209</td> <td>1.4[0.055]</td> <td>9.8[1.0]</td> </tr> <tr> <td>CB321611</td> <td>2.8[0.079]</td> <td>19.6[2.0]</td> </tr> <tr> <td>CB321616</td> <td>2.8[0.079]</td> <td>19.6[2.0]</td> </tr> <tr> <td>CB322513</td> <td>2.8[0.079]</td> <td>24.5[2.5]</td> </tr> <tr> <td>CB451616</td> <td>2.8[0.079]</td> <td>19.6[2.0]</td> </tr> <tr> <td>CB453215</td> <td>2.7[0.106]</td> <td>24.5[2.5]</td> </tr> </tbody> </table>	Type	A(mm) [inches]	P(N) [kgf]	CB201209	1.4[0.055]	9.8[1.0]	CB321611	2.8[0.079]	19.6[2.0]	CB321616	2.8[0.079]	19.6[2.0]	CB322513	2.8[0.079]	24.5[2.5]	CB451616	2.8[0.079]	19.6[2.0]	CB453215	2.7[0.106]	24.5[2.5]
Type	A(mm) [inches]	P(N) [kgf]																					
CB201209	1.4[0.055]	9.8[1.0]																					
CB321611	2.8[0.079]	19.6[2.0]																					
CB321616	2.8[0.079]	19.6[2.0]																					
CB322513	2.8[0.079]	24.5[2.5]																					
CB451616	2.8[0.079]	19.6[2.0]																					
CB453215	2.7[0.106]	24.5[2.5]																					
Flexure Strength	No mechanical damage shall be noticed even when the board is bent 2mm [0.079 inches].																						
Thermal Shock (Temperature Cycle)	Impedance shall be within ± 20% of the initial value.	Temperature: -25°C [-13°F], +85°C [+185°F] for 30 minutes each, 50 cycles.																					
High Temperature Resistance		Applied 200mA DC and placed at 80°C [176°F] for 500 hours, then measured at room ambient temperature.																					
Humidity Resistance		Applied 200mA DC and placed at 90%RH, 60°C [140°F] for 500 hours, then measured at room ambient temperature.																					
Drop		Drop 10 times on a concrete floor from a height of 1m [39.370 inches]																					
Vibration		Frequency: 10 to 55Hz Amplitude: 1.52mm [0.060 inches] Direction and time: X, Y and Z direction for 2 hours each.																					
Solvent Resistance		Solvent: Trichloroethylene Washer: Ultrasonic washer (100W) Washing time: 3 minutes																					

Packing

Available in Bulk, or Tape and Reels

Tape Dimensions

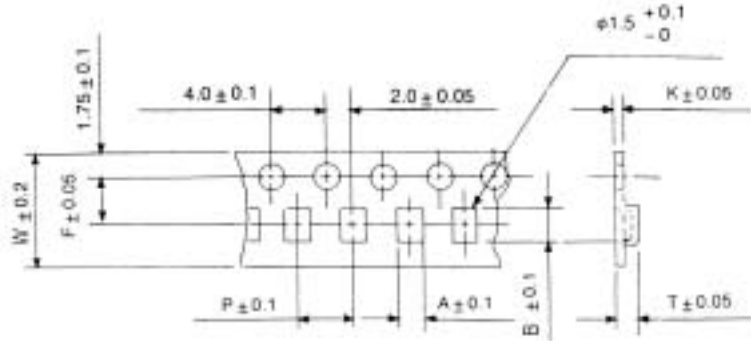

Type	CB160808	CB201209	CB321611	CB321616	CB322513	CB451616	CB453215	CB575018	CB575032
A	1.5	1.5	1.9	1.9	2.9	1.9	3.6	5.6	5.6
B	2.3	2.3	3.5	3.5	3.6	4.9	4.9	6.4	6.4
W	8.0	8.0	8.0	8.0	8.0	12.0	12.0	14.0	14.0
T	4.0	4.0	4.0	4.0	4.0	4.0	8.0	8.0	8.0
H	1.3	1.3	1.5	2.0	1.7	2.0	1.9	2.55	3.95
Chips/Reel	4000	4000	2000	2000	2000	2000	1000	500	500

Tape Material

Carrier Tape: Polystyrene

Cover Tape: Polystyrene

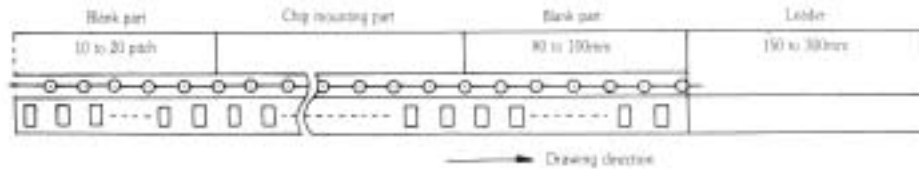

Reel Dimensions

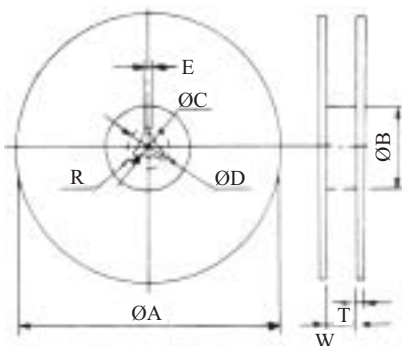

Type	160808	201209	321611	321616	322513	451616	453215	575018	575032
A			178 ± 2				178 ± 2		178 ± 2
B			60 ± 1				60 ± 1		60 ± 1
C			13.0 ± 0.5				13.0 ± 0.5		13.0 ± 0.5
D			21.0 ± 0.8				21.0 ± 0.8		21.0 ± 0.8
E			2.0 ± 0.5				2.0 ± 0.5		2.0 ± 0.5
W			10.0 ± 1.0				10.0 ± 1.0		10.0 ± 1.0
T			2.0 ± 0.5				2.0 ± 0.5		2.0 ± 0.5
R			1.0				1.0		1.0

- Typical | Z |, R, X<sub>L</sub> Frequency Characteristics

CB 201209T-151Y-C2

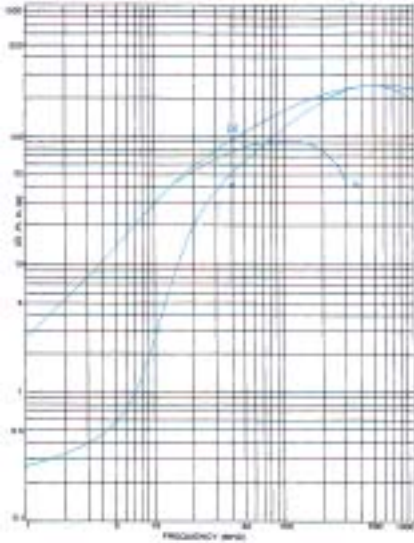

CB 201209T-601Y-C2

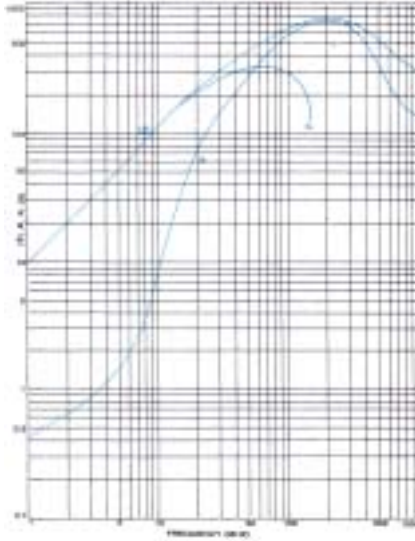

CB 321611T-320Y-C3

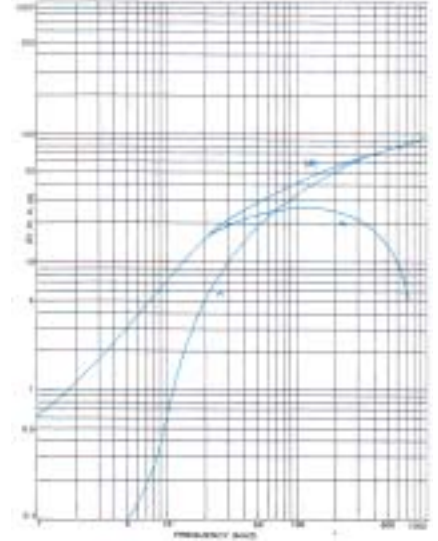

CB 321611T-601Y-C2

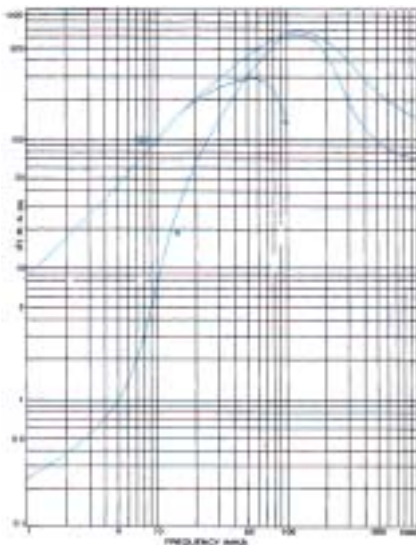

CB 322513T-900Y-C3

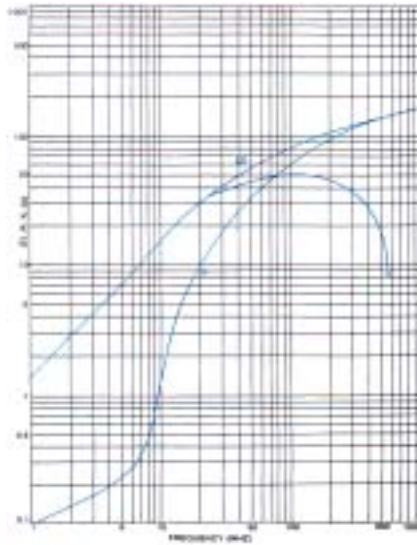

CB 453215T-121Y-C3

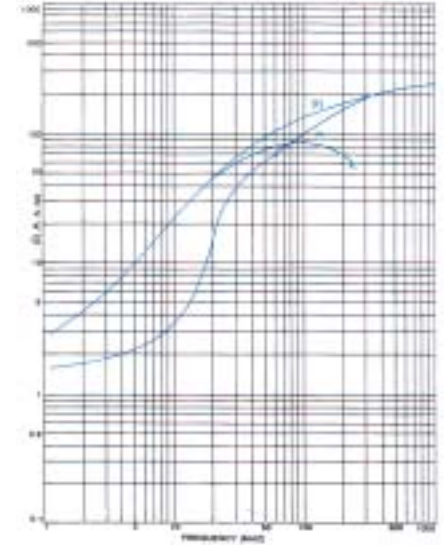

4. Electrical characteristics:

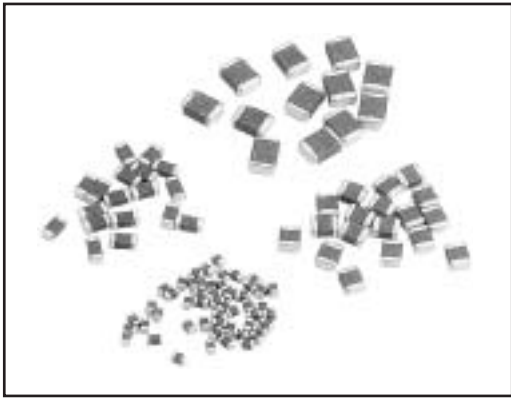

1. Shape:

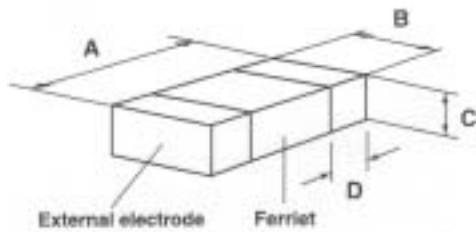

2. Ordering Code:

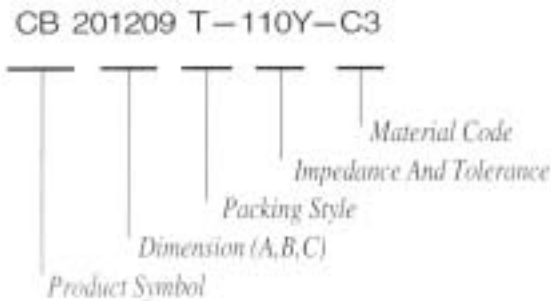

3. Dimensions in mm (inches):

Part No.	Impedance (Ω) At 100 MHz	DC Resistance (Ω) Max	Rated Current (mA) Max
CB160808T-400Y-C3	40 ± 25%	0.30	400
CB160808T-800Y-C3	80 ± 25%	0.50	300
CB160808T-121Y-C3	120 ± 25%	.070	200
CB160808T-301Y-C3	300 ± 25%	1.20	150
CB201209T-110Y-C3	11 ± 25%	0.10	600
CB201209T-320Y-C3	32 ± 25%	0.30	500
CB201209T-121Y-C3	120 ± 25%	0.50	300
CB201209T-181Y-C3	180 ± 25%	0.70	200
CB201209T-301Y-C3	300 ± 25%	0.80	200
CB201209T-601Y-C3	600 ± 25%	0.90	200
CB201209T-102Y-C3	1000 ± 25%	1.00	100
CB321611T-320Y-C3	32 ± 25%	0.15	500
CB321611T-900Y-C3	90 ± 25%	0.30	400
CB321611T-151Y-C3	150 ± 25%	0.40	200
CB321611T-301Y-C3	300 ± 25%	0.50	200
CB321611T-601Y-C3	600 ± 25%	0.50	200
CB321611T-102Y-C3	1000 ± 25%	1.00	100
CB321616T-600Y-C3	60 ± 25%	0.50	200
CB322513T-320Y-C3	32 ± 25%	0.30	400
CB322513T-600Y-C3	60 ± 25%	0.30	400
CB322513T-900Y-C3	90 ± 25%	0.30	400
CB451616T-600Y-C3	60 ± 25%	0.30	400
CB451616T-151Y-C3	150 ± 25%	0.50	200
CB453215T-700Y-C3	70 ± 25%	0.40	300
CB453215T-121Y-C3	120 ± 25%	0.40	300
CB575018T-101Y-C3	100 ± 25%	0.04	3000
CB575032T-301Y-C3	300 ± 25%	0.04	3000
CB575032T-401Y-C3	400 ± 25%	0.04	3000

Part No.	A	B	C	D
CB 160808	1.6 ± 0.20 (0.063 ± 0.008)	0.9 ± 0.20 (0.035 ± 0.008)	0.9 ± 0.20 (0.035 ± 0.008)	0.3 ± 0.20 (0.012 ± 0.008)
CB 201209	2.0 ± 0.20 (0.079 ± 0.008)	1.25 ± 0.20 (0.047 ± 0.008)	0.9 ± 0.20 (0.035 ± 0.008)	0.5 ± 0.30 (0.020 ± 0.012)
CB 321611	3.2 ± 0.20 (0.126 ± 0.008)	1.6 ± 0.20 (0.063 ± 0.008)	1.1 ± 0.20 (0.043 ± 0.008)	0.5 ± 0.30 (0.020 ± 0.012)
CB 321616	3.2 ± 0.20 (0.126 ± 0.008)	1.6 ± 0.20 (0.063 ± 0.008)	1.6 ± 0.20 (0.063 ± 0.008)	0.5 ± 0.30 (0.020 ± 0.012)
CB 322513	3.2 ± 0.20 (0.126 ± 0.008)	2.50 ± 0.20 (0.098 ± 0.008)	1.3 ± 0.20 (0.051 ± 0.008)	0.5 ± 0.30 (0.020 ± 0.012)
CB 451616	4.5 ± 0.25 (0.177 ± 0.008)	1.60 ± 0.20 (0.063 ± 0.008)	1.60 ± 0.20 (0.063 ± 0.008)	0.5 ± 0.30 (0.020 ± 0.012)
CB 453215	4.5 ± 0.25 (0.177 ± 0.008)	3.20 ± 0.20 (0.126 ± 0.008)	1.5 ± 0.20 (0.059 ± 0.008)	0.5 ± 0.30 (0.020 ± 0.012)
CB 575018	5.7 ± 0.40 (0.225 ± 0.016)	5.00 ± 0.30 (0.197 ± 0.012)	1.80 ± 0.30 (0.071 ± 0.012)	0.5 ± 0.30 (0.020 ± 0.012)
CB 575032	5.7 ± 0.40 (0.225 ± 0.016)	5.00 ± 0.30 (0.197 ± 0.012)	3.20 ± 0.30 (0.126 ± 0.012)	0.5 ± 0.30 (0.020 ± 0.012)

1. Ordering Code:

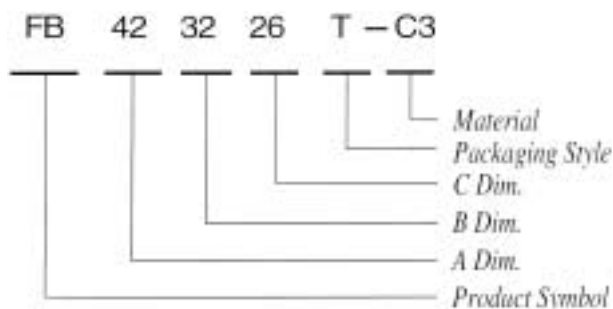

2. Shape:

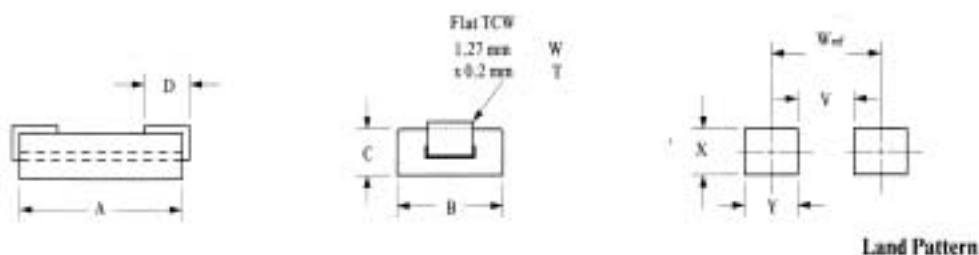

3. Dimensions: (m/m)

Part Number	A	B	C	D	V	Wref	X	Y
FB423226	4.0 ± 0.25	3.0 ± 0.15	2.55 ± 0.15	1.5 ± 0.5	1.9	4.9	3.0	3.0
FB863226	8.5 ± 0.3	3.0 ± 0.15	2.55 ± 0.15	1.5 ± 0.5	6.4	9.4	3.0	3.0
FB784729	7.8 ± 0.4	4.75 ± 0.25	2.92 ± 0.25	1.50.5	5.5	8.7	3.0	3.0

4. Electrical Characteristics:

Part Number	Impedance (Ω) Min.		Rdc (Ω) Max.
	25MHz	100MHz	
FB423226-C3	20	35	0.6
FB863226-C3	45	80	0.9
FB784729-C3	45	80	0.9

TEST INSTRUMENTS:  
HP419A RF IMPEDANCE ANALYZER

5. Packaging: 500 pcs. per Reel



Material	Ui	Working Frequency (MHz)	Tan $\delta$ / ui X10 <sup>-5</sup>	Bms Gauss	Br Gauss	HC Oe	TC °C	$\rho$ ( $\Omega$ -cm)
A	550	0.1~2	2.3 (0.2 MHz)	2700	800	0.28	150	10 <sup>7</sup>
A1	200	0.4~2	5.0 (0.2 MHz)	2600	600	0.14	150	10 <sup>7</sup>
A2G	300	0.4~2	2.0 (0.4 MHz)	2700	1600	0.52	150	10 <sup>7</sup>
A3	250	0.1~6	18.0 (1 MHz)	3000	1500	0.75	200	10 <sup>7</sup>
A5	100	0.5~20	5.0 (2 MHz)	3000	1800	2.0	330	10 <sup>4</sup>
B7	750	0.1~0.7	7.0 (0.3 MHz)	2900	600	0.3	130	10 <sup>7</sup>
B8	800	0.1~0.7	6.9 (0.5 MHz)	2400	850	0.3	140	10 <sup>7</sup>
B10	1000	0.01~0.5	2.0 (0.1 MHz)	2900	900	0.35	100	10 <sup>7</sup>
B12	1200	0.01~0.5	2.1 (0.1 MHz)	2900	900	0.3	100	10 <sup>7</sup>
B15	1500	0.01~0.5	6.0 (0.1MHz)	2800	600	0.2	100	10 <sup>7</sup>
B18	1800	0.01~0.5	2.5 (0.1 MHz)	2900	700	0.16	100	10 <sup>7</sup>
B30	3000	0.01~0.5	2.0 (0.1 MHz)	2800	650	0.08	100	10 <sup>7</sup>
K1	55	0.5~15	10.0 (2 MHz)	2800	1150	3.6	300	10 <sup>7</sup>
K2	70	0.5~15	10.0 (2 MHz)	2900	2200	3.48	300	10 <sup>7</sup>
K3	10	10~150	40.0 (10 MHz)	1400	500	16.9	300	10 <sup>7</sup>
DB3	300	0.1~2	4.0 (0.4 MHz)	2900	1500	0.56	180	10 <sup>7</sup>
N9D	50	0.5~50	18 (2 MHz)	3100	2250	6.6	300	10 <sup>7</sup>
C2	200	0.1~2	5.3 (1 MHz)	2400	630	1.9	175	10 <sup>7</sup>
C3	300	0.1~1	3.2 (1 MHz)	2800	1440	0.8	175	10 <sup>7</sup>

Page 3



EMI SURFACE MOUNT BEADS / FB TYPE

Page 20



FLAT CABLE EMI CORES / FP FI TYPE

Page 26



MULTI-APERTURE CORES / RID TYPE

Page 4



EMI MULTILAYER FERRITE CHIP BEADS / CB TYPE

Page 22



ROUND CABLE EMI CORES / FH TYPE

Page 27



ANTENNA FERRITE BAR / AP AR TYPE

Page 12



EMI BEAD CORES / RH TYPE

Page 24



CONNECTOR EMI CORES / FD FDH TYPE

Page 31



Mn-Zn TOROID CORES

Page 16



EMI TOROID CORES / T TYPE

Page 25



MULTI-APERTURE WOUND BEADS / R6H TYPE

Page 33



IRON POWDER CORES

4. Shape:

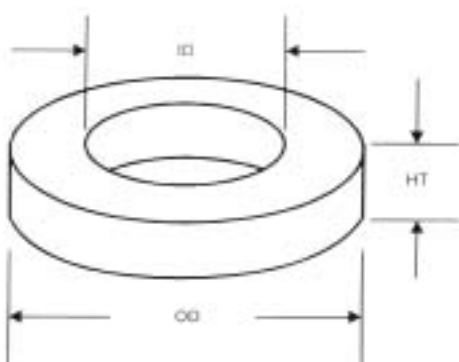

5. Dimensions and Magnetic Parameters

PART NO.	OD m/m	HT m/m	ID m/m	AL nH/N <sup>2</sup>	L cm	A cm <sup>2</sup>
T37-26	9.53 ± 0.4	3.25 ± 0.4	5.2 ± 0.4	26 <sup>-0</sup>	2.31	0.64
T44-36	11.2 ± 0.4	4.04 ± 0.4	5.82 ± 0.4	34 <sup>-0</sup>	2.68	0.99
T50-26	12.7 ± 0.4	4.83 ± 0.4	7.7 ± 0.4	31 <sup>-0</sup>	3.20	0.12
T50-26B	12.7 ± 0.4	6.35 ± 0.4	7.7 ± 0.4	41 <sup>-0</sup>	3.20	0.15
T50-26D	12.7 ± 0.4	9.35 ± 0.4	7.7 ± 0.4	67 <sup>-0</sup>	3.20	0.22
T60-26	15.2 ± 0.4	5.94 ± 0.4	8.53 ± 0.4	47 <sup>-0</sup>	3.74	0.19
T68-26	17.5 ± 0.4	4.83 ± 0.4	9.4 ± 0.4	41 <sup>-0</sup>	4.24	0.19
T68-26A	17.5 ± 0.4	6.35 ± 0.4	9.4 ± 0.4	54 <sup>-0</sup>	4.24	0.24
T80-26	20.2 ± 0.4	6.35 ± 0.4	12.6 ± 0.4	43 <sup>-0</sup>	5.15	0.24
T80-26B	20.2 ± 0.4	9.53 ± 0.4	12.6 ± 0.4	66 <sup>-0</sup>	5.15	0.35
T90-26	22.9 ± 0.5	9.53 ± 0.5	1.40 ± 0.5	65 <sup>-0</sup>	5.80	0.42
T106-26	26.9 ± 0.5	11.1 ± 0.5	14.5 ± 0.5	87 <sup>-0</sup>	6.50	0.69
T130-26	33.0 ± 0.5	11.1 ± 0.5	19.8 ± 0.5	76 <sup>-0</sup>	8.29	0.73
T130-26A	33.0 ± 0.5	5.72 ± 0.5	19.8 ± 0.5	40 <sup>-0</sup>	8.29	0.36