

## CBT-120-UV LEDs

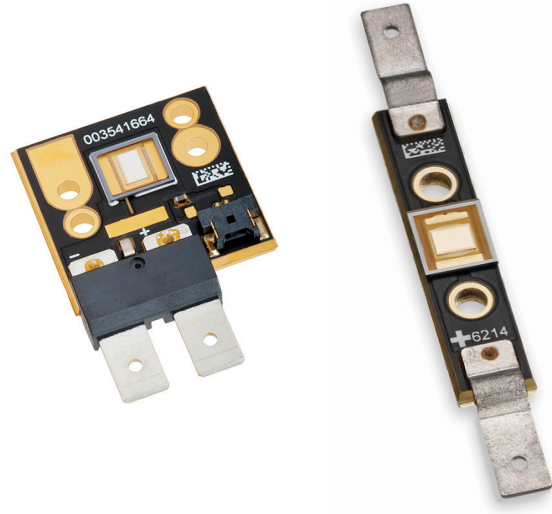

### Table of Contents

Technology Overview .....2

Binning Structure .....3

Optical & Electrical Characteristics .....4

Optical Electrical Characteristics Graphs .....5

CBT-120 Reliability and Typical Spectrum.....6

Thermal Resistance Slim Package(C14) .....7

Thermal Resistance Square Package (C31).....8

Mechanical Dimensions Slim Package (C14).....9

Mechanical Dimensions Square Package (C31)..... 10

Ordering Information .... 11

### Features:

- Over 16.0W of optical power.
- High thermal conductivity package .
  - › Junction to heat sink thermal resistance of  $< 1 \text{ }^\circ\text{C/W}$
- UV LED technology for very high power density and uniform emission
- Large, monolithic chip with surface emitting area of  $12 \text{ mm}^2$ , 16:9 aspect ratio
- Low-profile window for efficient coupling into small-etendue systems
- High radiometric efficiency
- Environmentally friendly: RoHS compliant, mercury-free
- Variable drive currents: less than 1 A through 30 A
- NIST traceable optical and electrical measurement testing

### Applications

- Curing:
  - › Inks
  - › Coatings
  - › Adhesives
- Inspection
- Machine Vision
- Fiber-coupled illumination
- Specialty Projection Systems for Maskless Lithography:
  - › Optically matched to TI 0.95" DMD
- Rapid Prototyping and 3D printing
- Medical and Scientific Instrumentation

## Technology Overview

Luminus LEDs benefit from innovations in device technology, chip packaging and thermal management. This suite of technologies give engineers and system designers the freedom to develop solutions both high in power and efficiency.

### Luminus Technology

Luminus' technology enables large area LED chips to emit photons uniformly over the entire LED chip surface. The intense optical power density produced by these UV LEDs facilitate designs which replace arc and halogen lamps where arrays of traditional high power LEDs cannot.

For UV devices, Luminus engineers the LEDs to maximize light extraction and to emit with a Lambertian far-field distribution pattern. The design maximizes efficiency and allows for flexible optical designs.

### Packaging Technology

Thermal management is critical in high power LED applications. Luminus CBT-120-UV LEDs have the lowest thermal resistance of any LED on the market with a thermal resistance from junction to heat sink of 0.73°C/W or 0.88°C/W. This allows the LED to be driven at higher current densities while maintaining a low junction temperature, thereby resulting in brighter solutions and longer lifetimes.

### Reliability

Designed from the ground up, Luminus LEDs are one of the most reliable light sources in the world today. Luminus LEDs have passed a rigorous suite of environmental and mechanical stress tests, including mechanical shock, vibration, temperature cycling and humidity, and have been fully qualified for use in extreme high power and high current applications. With very low failure rates and median lifetimes that typically exceed 10,000 hours, Luminus LEDs are ready for even the most demanding applications.

### Environmental Benefits

Luminus LEDs help reduce power consumption and the amount of hazardous waste entering the environment. All LED products manufactured by Luminus are RoHS compliant and free of hazardous materials, including lead and mercury.

## Understanding Big Chip LED Test Specifications

Every Luminus LED is fully tested to ensure that it meets the high quality standards expected from Luminus' products.

### Testing Temperature

Luminus core board products are typically measured in such a way that the characteristics reported agree with how the devices will actually perform when incorporated into a system. This measurement is accomplished by mounting the devices on a 40°C heat sink and measuring the device while fully powered. This method of measurement ensures that Luminus LEDs perform in the field just as they are specified.

### Multiple Operating Points

The tables on the following pages provide typical optical and electrical characteristics for the standard drive conditions. Since the LEDs can be operated over a wide range of drive conditions (currents from <1A to 30 A, and duty cycle from <1% to 100%) there are many other potential values attainable. Driving devices beyond recommended driving conditions shortens lifetime (see derating curves on page 6).

### CBT-120-UV Binning Structure

CBT-120-UV LEDs are specified for luminous flux and chromaticity/wavelength at a drive current of 18 A (1.5 A/mm<sup>2</sup>) and placed into one of the following Power Bins and Wavelength Bins:

#### Power Bins

Color	Power Flux Bin (F)	Minimum Flux (W)	Maximum Flux (W)
UV	M	13.3	14.6
	N	14.6	16.1
	P	16.1	17.7
	Q	17.7	19.5
	R	19.5	21.4

\*Note: Luminus maintains a +/- 6% tolerance on power measurements.

#### Wavelength Bins

Color	Wavelength Bin (123)	Minimum Wavelength (nm)	Maximum Wavelength (nm)
UV	382	382	387
	387	387	392
	392	392	400
	400	400	405
	405	405	410

**Reference Optical & Electrical Characteristics ( $T_{hs} = 40^{\circ}\text{C}$ )<sup>1,2</sup>**

UV				
Drive Condition <sup>3</sup>		18 A	18 A	
Parameter	Symbol	Values <sup>4</sup>		Unit
Current Density	$j$	1.5	2.5	A/mm <sup>2</sup>
Forward Voltage	$V_{Fmin}$	3.3	3.3	V
	$V_F$	3.7	3.4	V
	$V_{Fmax}$	5.9	5.9	V
Radiometric Flux <sup>5</sup>	$\Phi_{typ}$	16.0	19.0	W
Radiometric Flux Density	$\Phi_R$	1.3	1.6	W/mm <sup>2</sup>
Wavelength Range	$\lambda$	382 - 392	400 - 410	nm
Peak Wavelength	$\lambda_p$	387	405	nm
FWHM	$\Delta\lambda_{1/2}$	12	12	nm

	Symbol	UV	Unit
Emitting Area		12.0	mm <sup>2</sup>
Emitting Area Dimensions		4.63 × 2.6	mm × mm
Dynamic Resistance	$\Omega_{dyn}$	0.02	$\Omega$

**Absolute Maximum Ratings**

	Symbol	UV	Unit
Maximum Current <sup>6</sup>		30	A
Maximum Junction Temperature <sup>7</sup>	$T_{jmax}$	150	$^{\circ}\text{C}$
Storage Temperature Range		-40 to +100	$^{\circ}\text{C}$

Note 1: Data verified using NIST traceable calibration standard.

Note 2: All data are based on test conditions with a constant heat sink temperature  $T_{hs} = 40^{\circ}\text{C}$  under pulse testing conditions. Pulse conditions: 25% duty-cycle and frequency of 360 Hz. Nominal  $T_j \approx 80^{\circ}\text{C}$ . See Thermal Resistance section for  $T_j$  and  $T_{hs}$  definition.

Note 3: Listed drive conditions are typical for common applications. CBT-120-UV devices can be driven at currents ranging from <1 A to 30 A and at duty cycles ranging from 1% to 100%. Drive current and duty cycle should be adjusted as necessary to maintain the junction temperature desired to meet application lifetime requirements.

Note 4: Unless otherwise noted, values listed are typical. Devices are production tested and specified at 18 A.

Note 5: Typical total flux from emitting area at listed peak wavelength. Reported performance is included to show trends for a selected power level. For specific minimum and maximum values, use bin tables. For product roadmap and future performance of devices, contact Luminus.

Note 6: CBT-120-UV LEDs are designed for operation to an absolute maximum current as specified above. Product lifetime data is specified at recommended forward drive currents. Sustained operation at or beyond absolute maximum currents will result in a reduction of device life time compared to recommended forward drive currents. Actual device lifetimes will also depend on junction temperature. Refer to the lifetime derating curves for further information. In pulsed operation, rise time from 10-90% of forward current should be longer than 0.5  $\mu\text{seconds}$ .

Note 7: Lifetime dependent on LED junction temperature. Input power and thermal system must be properly managed to ensure lifetime. See charts on page 5 for further information.

Note 8: Special design considerations must be observed for operation under 1 A. Please contact Luminus for further information.

## Optical & Electrical Characteristics

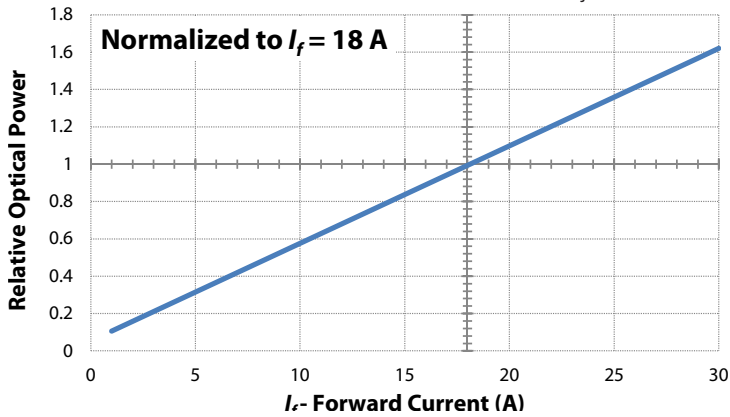
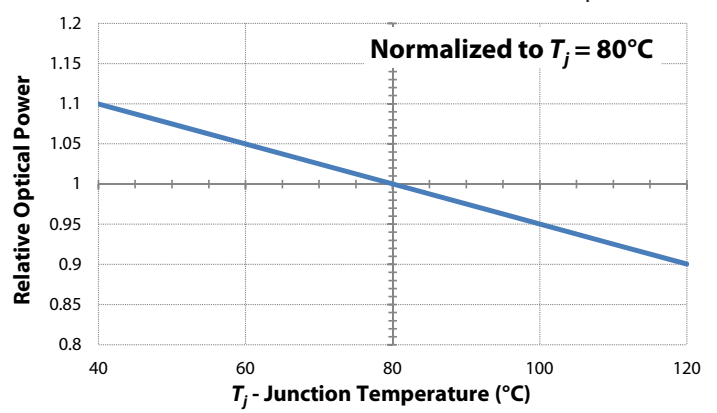
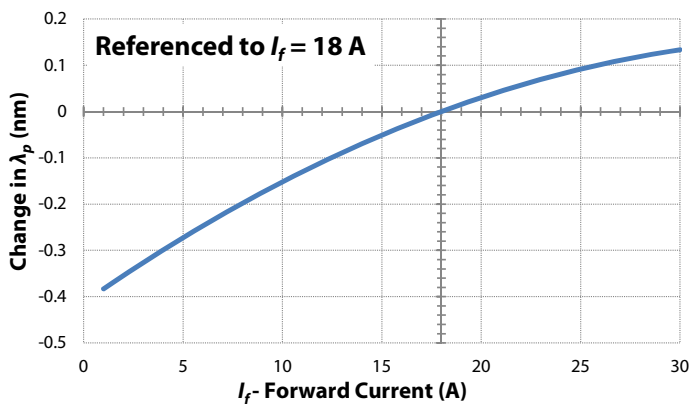
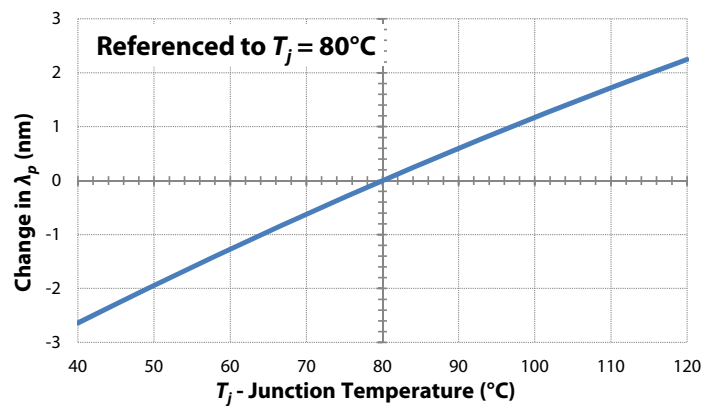
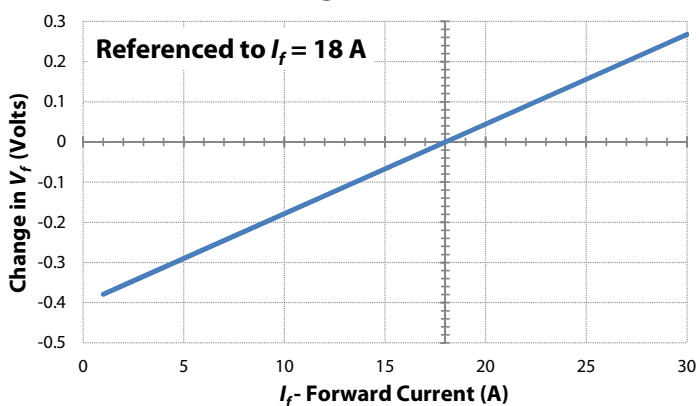
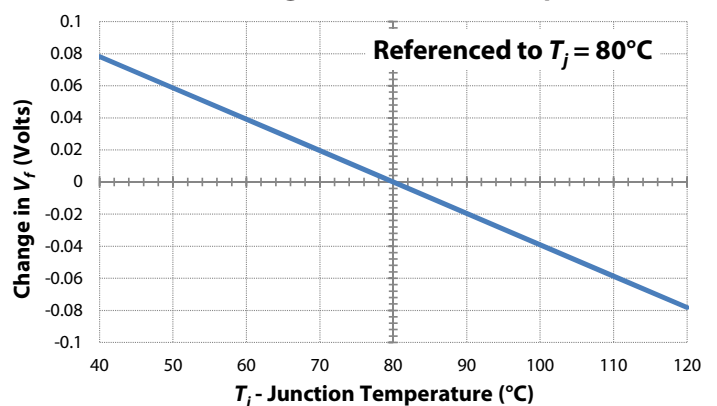
**Relative Power vs Forward Current,  $T_j = 120^\circ\text{C}$** 

**Relative Power vs Junc. Temperature,  $I_f = 18\text{ A}$** 

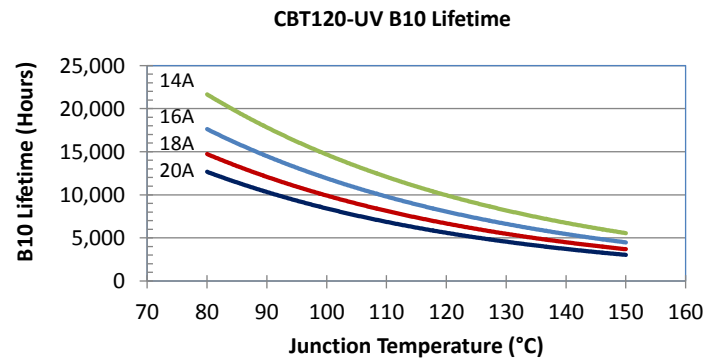
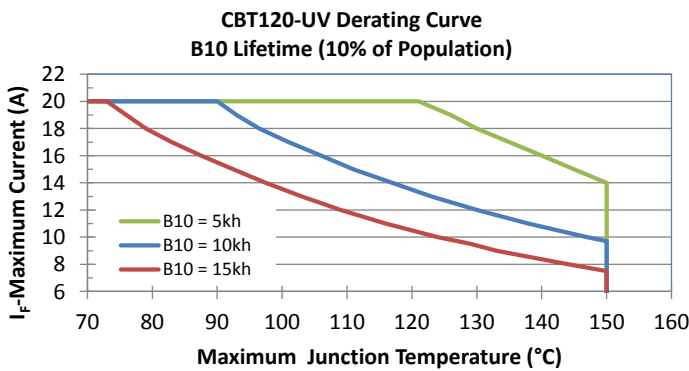
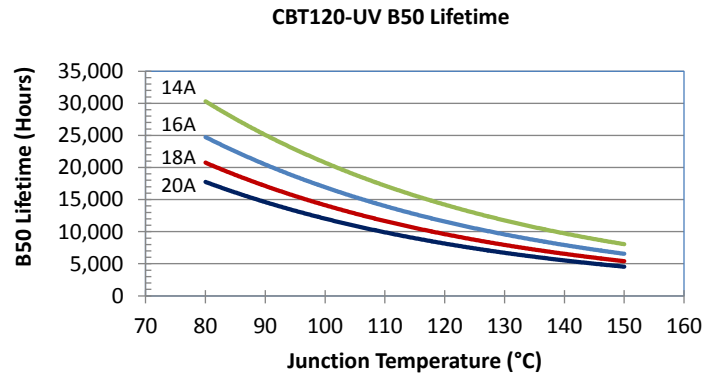
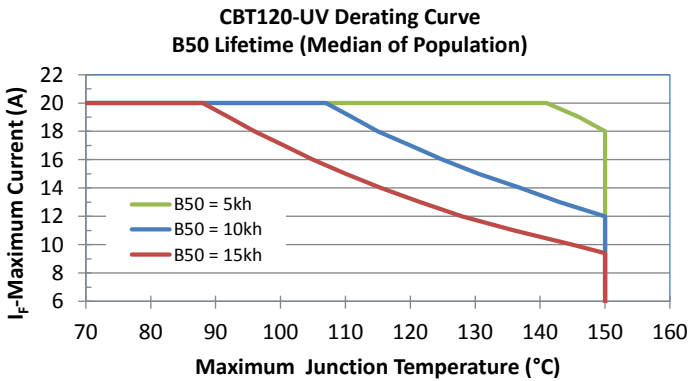
**Peak Wavelength vs Forward Current**

**Peak Wavelength vs Junction Temperature**

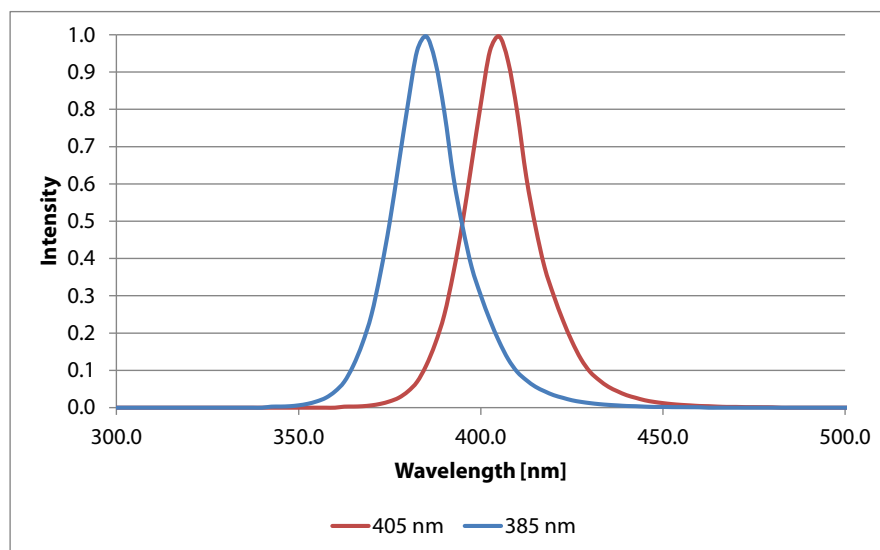
**Forward Voltage vs Forward Current**

**Forward Voltage vs Junction Temperature**

### CBT-120-UV Reliability<sup>10</sup>



### Typical Spectrum<sup>11</sup>



Note 10. Lifetime defined as time to 70% of initial intensity. Based on preliminary lifetime test data. Data can be used to model failure rate over typical product lifetime.

Note 11. Typical spectrum at current of 18 A in continuous operation.

## Typical Radiation Pattern

### Typical Angular Radiation Pattern

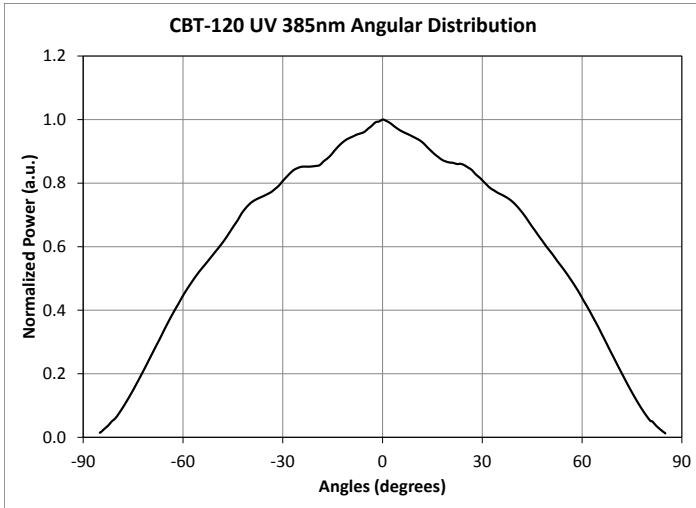

### Typical Polar Radiation Pattern

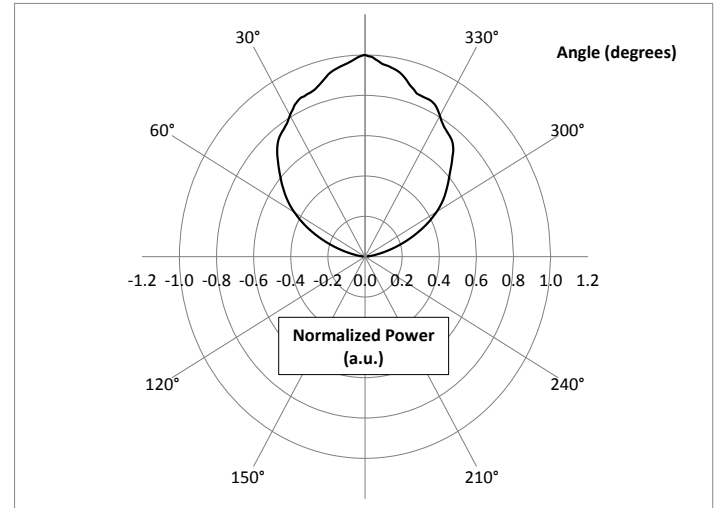

## Thermal Resistance CBT-120-UV-C14

### Typical Thermal Resistance

$R_{\theta j-b}^1$	0.76 °C/W
$R_{\theta b-hs}^1$	0.12 °C/W
$R_{\theta j-hs}^2$	0.88 °C/W

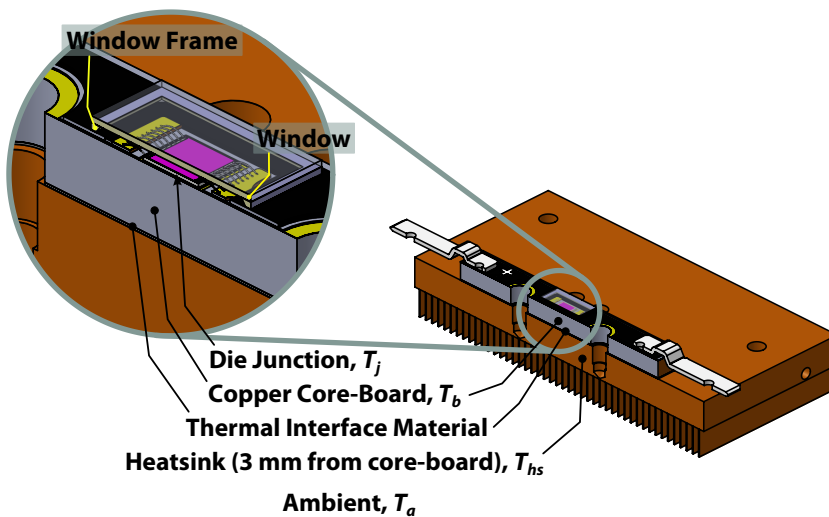

Note 1: Thermal resistance values are based on FEA model results correlated to measured  $R_{\theta j-hs}$  data.

Note 2: Thermal Resistance is based on Fujipoly Thermal interface.

### Thermal Resistance CBT-120-UV-C31

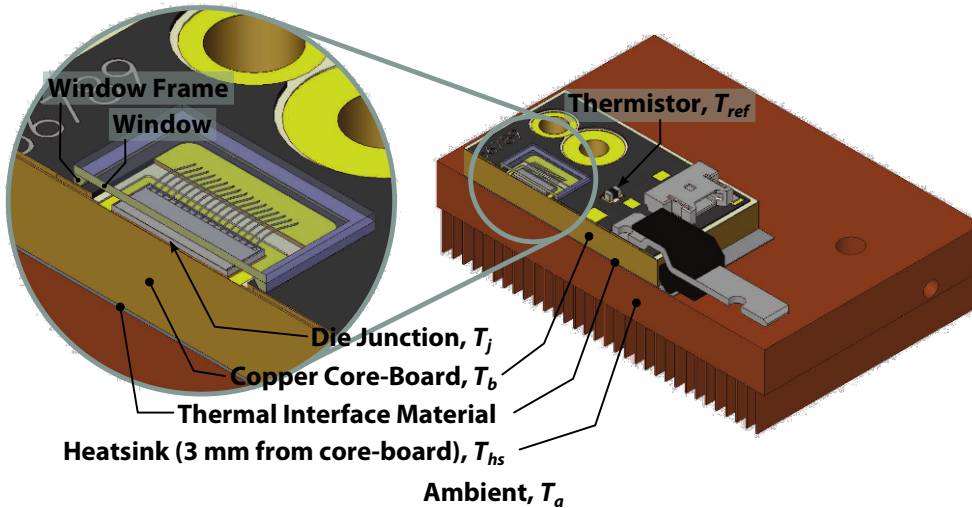

#### Typical Thermal Resistance

$R_{\theta j-b}^1$	0.61 °C/W
$R_{\theta b-hs}^1$	0.12 °C/W
$R_{\theta j-hs}^2$	0.73 °C/W
$R_{\theta j-ref}^1$	0.64 °C/W

Note 1: Thermal resistance values are based on FEA model results correlated to measured  $R_{\theta j-hs}$  data.

Note 2: Thermal Resistance is based on eGraf 1205 Thermal interface.

### Electrical Pinout

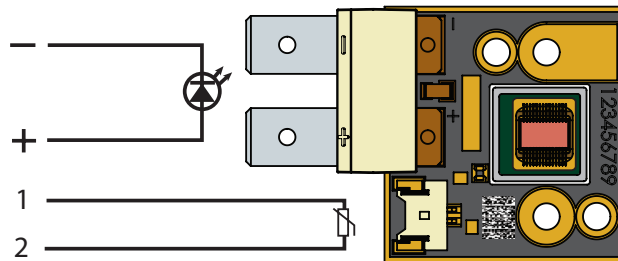

### Thermistor Information

The thermistor used in CBT-120 devices mounted on coreboards is from Murata Manufacturing Co. The global part number is NCP18XH103J03RB. Please see <http://www.murata.com/> for details on calculating thermistor temperature.

For more information on use of the thermistor, please contact Luminus directly.

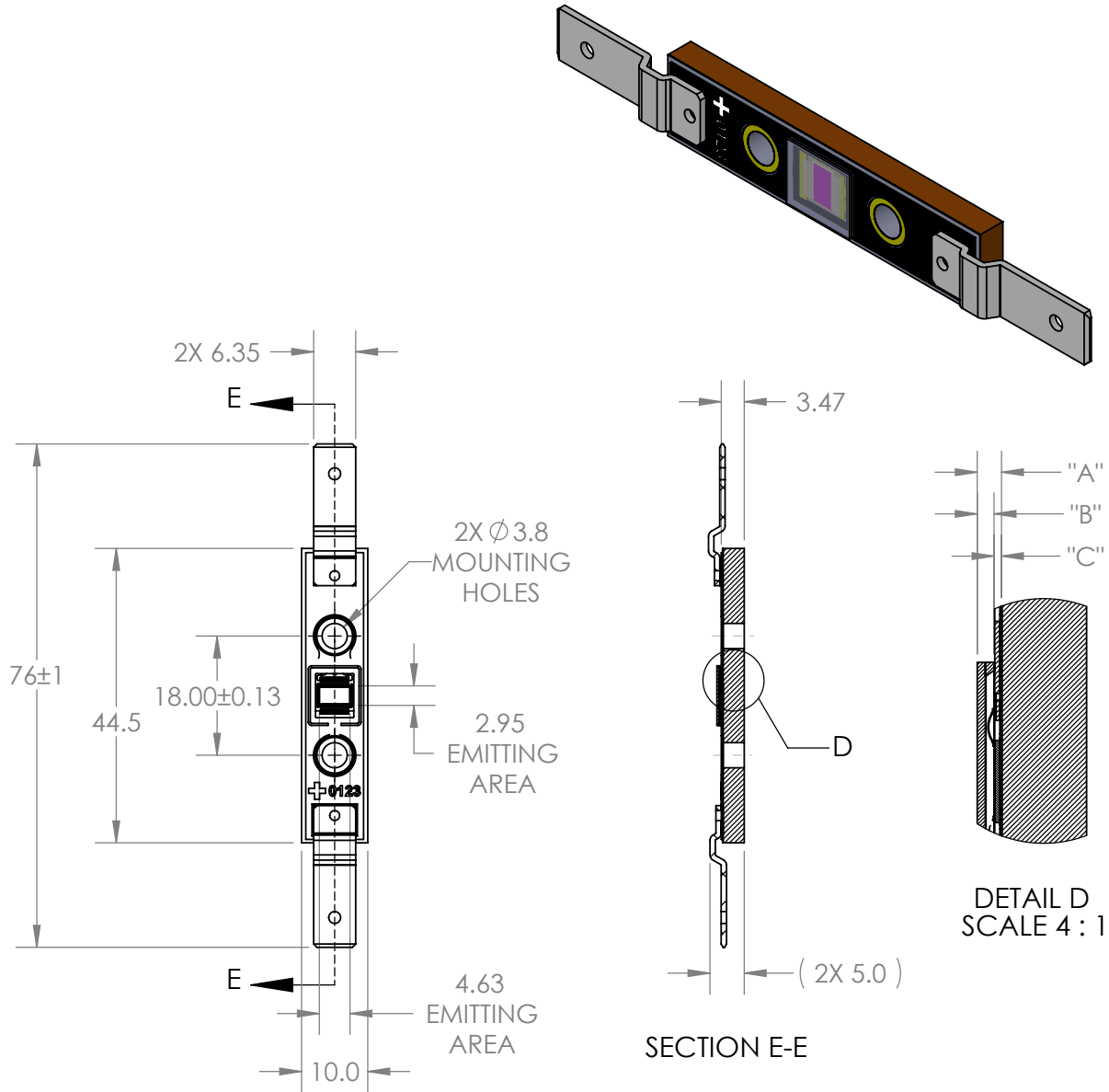

**Mechanical Dimensions – CBT-120-UV-C14 Emitter**

DIMENSIONS IN MILLIMETERS

DIMENSION NAME	DESCRIPTION	NOMINAL DIMENSION	TOLERANCE
"A"	TOP OF METAL SUBSTRATE TO TOP OF GLASS	.93	±0.07
"B"	TOP OF EMITTING AREA TO TOP OF GLASS	.64	±0.07
"C"	TOP OF METAL SUBSTRATE TO EMITTING AREA	.28	±0.05

DWG-001898

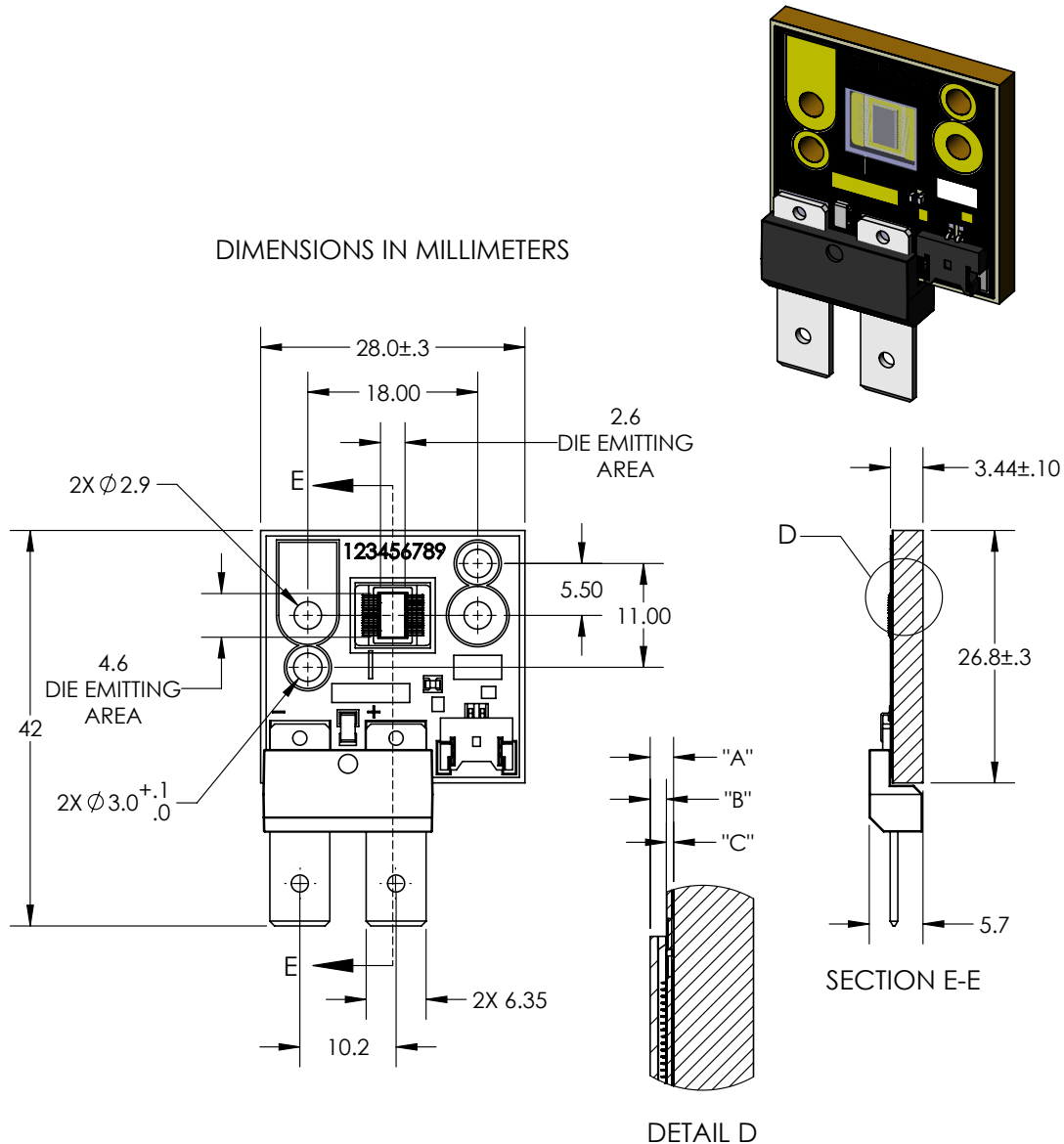
**Mechanical Dimensions – CBT-120-UV-C31 Emitter**

DIMENSION NAME	DESCRIPTION	NOMINAL DIMENSION	TOLERANCE
"A"	TOP OF METAL SUBSTRATE TO TOP OF WINDOW	0.91	$\pm 0.13$
"B"	TOP OF DIE EMITTING AREA TO TOP OF WINDOW	0.61	$\pm 0.11$
"C"	TOP OF METAL SUBSTRATE TO TOP OF DIE EMITTING AREA	0.27	$\pm 0.02$

DWG-002179

Recommended connector for Anode and Cathode: Panduit Disco Lok™ Series P/N: DNG14-250FL-C.

Thermistor Connector: MOLEX P/N 53780-0270. Recommended Female: MOLEX P/N 51146-0200 or equivalent.

### Ordering Information

Products	Ordering Part Number	Description
CBT-120-UV	CBT-120-UV-C31-x123-22	CBT-120-UV consisting of a 12 mm <sup>2</sup> LED, a thermistor, connectors, and a square copper-core PCB.
	CBT-120-UV-C14-x123-22	CBT-120-UV consisting of a 12 mm <sup>2</sup> LED, connectors, and a slim (rectangular) copper-core PCB.

*Note 1: For information on ordering specific bins or bin ranges please refer to the CBT-120-UV Binning and Labeling document PDS-001911.*



The products, their specifications and other information appearing in this document are subject to change by Luminus Devices without notice. Luminus Devices assumes no liability for errors that may appear in this document, and no liability otherwise arising from the application or use of the product or information contained herein. None of the information provided herein should be considered to be a representation of the fitness or suitability of the product for any particular application or as any other form of warranty. Luminus Devices' product warranties are limited to only such warranties as accompany a purchase contract or purchase order for such products. Nothing herein is to be construed as constituting an additional warranty. No information contained in this publication may be considered as a waiver by Luminus Devices of any intellectual property rights that Luminus Devices may have in such information. Big Chip LEDs™ is a registered trademark of Luminus Devices, Inc., all rights reserved.

This product is protected by U.S. Patents 6,831,302; 7,074,631; 7,083,993; 7,084,434; 7,098,589; 7,105,861; 7,138,666; 7,166,870; 7,166,871; 7,170,100; 7,196,354; 7,211,831; 7,262,550; 7,274,043; 7,301,271; 7,341,880; 7,344,903; 7,345,416; 7,348,603; 7,388,233; 7,391,059 Patents Pending in the U.S. and other countries.