

SPECIFICATIONS

FOR TOPLIGHT 0.56 INCH (14.2mm) FOUR DIGIT

MODEL: **TOPLIGHT
CC-5461AS**



SHANGHAI TOPLIGHT TECHNOLOGY CO., LTD.

www.ledtoplight.com.cn



TECHNICAL DATA SHEET

CC-5461AS <FOR TOPLIGHT 0.56 INCH (14.2mm) FOUR DIGIT>

1/7

PRODUCT INTRODUCTION

FEATURES

- ※ 0.56 inch (14.2mm) digit height.
- ※ Low power requirement, solid state reliability.
- ※ Multicolor available, stackable horizontally.
- ※ Categorized for luminous intensity.
- ※ Easy mounting on P.C. boards.
- ※ Remain within RoHS compliant version.

DESCRIPTION

- ※ The TOPLIGHT-CC-5461AS is a 0.56 inch (14.2mm) digit height four digit numeric display.
- ※ This device is made with white segments and black surface.

APPLICATION

- ※ Digital readout display
- ※ Instrument panels
- ※ Elevator
- ※ Audio equipment

PART NO.	SIZE	CHIP EMITTED COLOR	FACE COLOR
TOPLIGHT-CC-5461AS	0.56 inch (14.2mm) digit height	Super Red	Black



TECHNICAL DATA SHEET

CC-5461AS <FOR TOPLIGHT 0.56 INCH (14.2mm) FOUR DIGIT>

2/7

PACKAGE DIMENSIONS

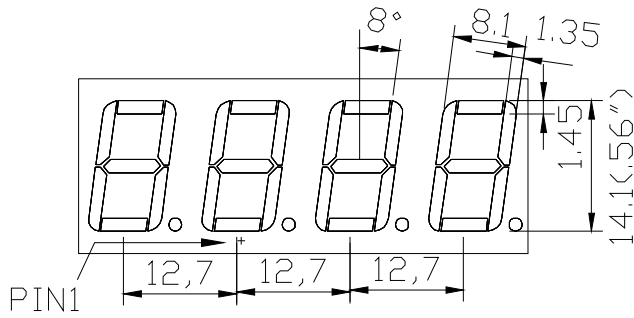

DIG. 1 DIG. 2 DIG. 3 DIG. 4

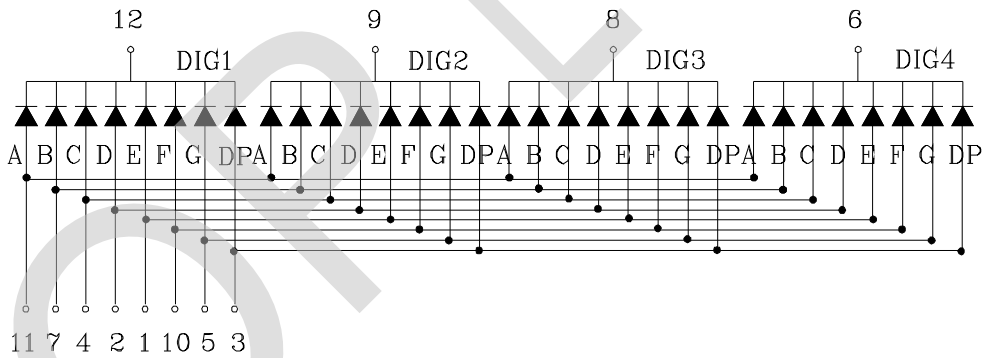
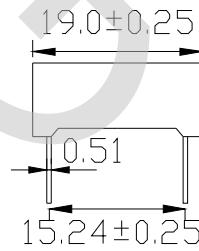
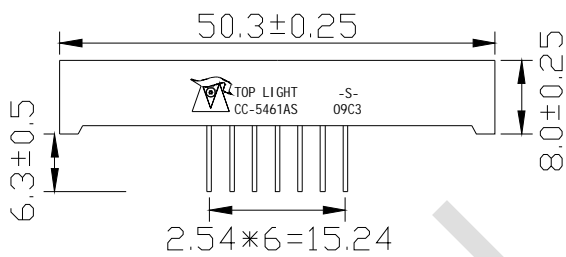
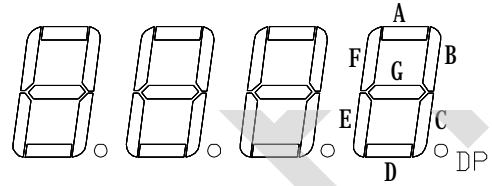



TECHNICAL DATA SHEET

CC-5461AS <FOR TOPLIGHT 0.56 INCH (14.2mm) FOUR DIGIT>

3/7

ELECTRICAL/OPTICAL CHARACTERISTIC (1)

ABSOLUTE MAXIMUM RATINGS (Ta=25° C)

PARAMETER PER SEGMENT	SYMBOL	MAX	UNIT
Reverse Voltage	V _R	5	V/seg
Forward Current	I _F	30	mA/seg
Peak Forward Current (1/10 Duty Cycle)	I _{PEAK}	120	mA/seg
Power Dissipation	P _D	80	mW/seg
Operating Temperature Range	T _A	- 35 ~ + 85	°C
Storage Temperature Range	T _{STG}	- 35 ~ + 85	°C

Solder Temperature 1/16 inch below seating plane for 3 seconds MAX 260°C

ELECTRICAL-OPTICAL CHARACTERISTICS (Ta=25° C)

PARAMETER	SYMBOL	MIN.	TYP.	MAX.	UNIT	TEST CONDITIONS	
Luminous Intensity	I _v	R	13500	15524	17549	ucd	I _F =10mA
		S	17550	21937	26325		
		T	26326	32907	39489		
Forward Voltage	V _F	1.80	2.10	2.40	V/seg	I _F =20mA	
Peak Emission Wavelength	λ _p	-	635	-	nm	I _F =20mA	
Spectral Line Half-Width	Δ λ	-	20	-	nm	I _F =20mA	
Reverse Current	I _R	-	-	20	uA	V _R =5v	



TECHNICAL DATA SHEET

CC-5461AS <FOR TOPLIGHT 0.56 INCH (14.2mm) FOUR DIGIT>

4/7

ELECTRICAL/OPTICAL CHARACTERISTIC (2)

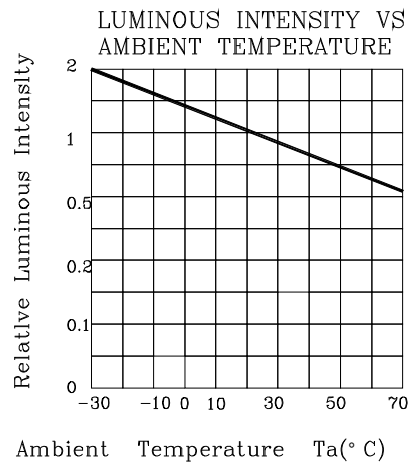
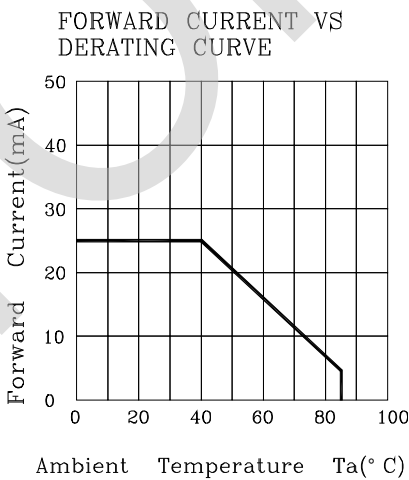
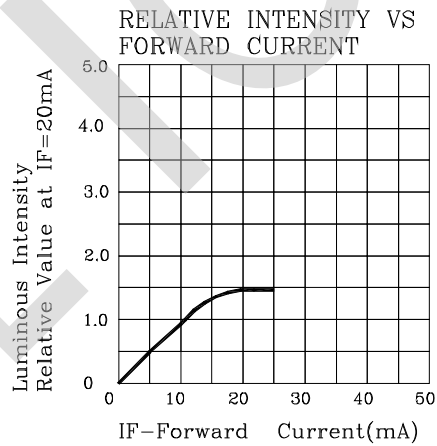
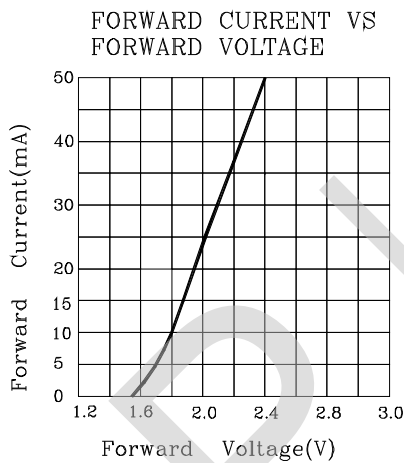
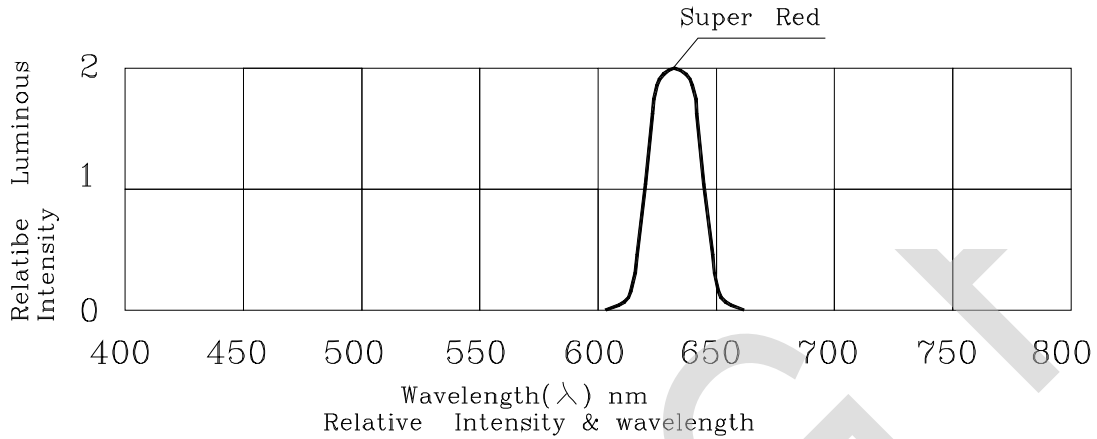



TECHNICAL DATA SHEET

CC-5461AS <FOR TOPLIGHT 0.56 INCH (14.2mm) FOUR DIGIT>

5/7

QUALITY CONTROL AND ASSURANCE

CLASSIFICATION	TEST ITEM	DESCRIPTION AND TEST CONDITION
ENDUTRANCE TEST	OPERATION LIFE	To evaluate resistance of the device when it operated at electrical stress Ta=under room temperature If=12mA-25mA per segment or Ip=80mA/duty=1/8,Pw=1.25mS Ip=160mA/duty=1/16,Pw=1.mS(DOT) Test time=1000HRS(-24HRS+72HRS)
	HIGH TEMPERATURE HIGH HUMIDITY STORAGE	To evaluate moisture resistance of the device when it stored for a long term at high temperature and high humidity Ta=65°C±5°C RH=90-95% Test time=240HRS±2HRS
	HIGH TEMPERATURE HIGH HUMIDITY REVERSE BIAS	To evaluate resistance of leakage current against long term thermal, humidity, and electrical stress Ta=65°C±5°C RH=90-95% VR=5V Test time=500hrs(-24HRS+48HRS)
	HIGH TEMPERATURE STORAGE	To evaluate device's durability for long term storage in high temperature Ta=85°C±5°C Test time=1000HRS(-24HRS+72HRS)
	LOW TEMPERATURE STORAGE	To evaluate device's durability for long term storage in low temperature Ta=-35°C±5°C Test time=1000HRS(-24HRS+72HRS)
ENVIRONMENTAL TEST	TEMPERATURE CYCLING	To evaluate resistance of devices under thermal stress, expansion and contraction Ta=85°C~25°C~-35°C time=30min 5min 30min 5min Cycle test:10cycles
	THERMAL SHOCK	To evaluate device's structural and mechanical resistance when suddenly exposed at serious changes Ta=85°C±5°C~-35°C±5°C time=10min 10min Cycle test:10cycles
	SOLOER RESISTANCE	To evaluate resistance of thermal stress caused by soldering T.sol=260°C±5°C time=10±1sec
	SOLOER ABILITY	To evaluate solderability on leads of device T.sol=230°C±5°C time=5±1sec



TECHNICAL DATA SHEET

CC-5461AS <FOR TOPLIGHT 0.56 INCH (14.2mm) FOUR DIGIT>

6/7

Display Soldering Conditions

The recommended conditions for soldering are as follows. Because the component is made with epoxy resin, the units are susceptible to heat. Therefore, the preheating and soldering temperatures should be kept as low as possible to avoid damage.

1 . Manual Soldering Conditions(with 1.5mm Iron tip)

Iron Tip Temperature: 350°C Max, Time: 3s Max

Position: The iron should be situated at least 2mm away from the root of the leads.

2 . Through the Wave Soldering Conditions

Wave Soldering Profile For Lead-free Through-hole LED

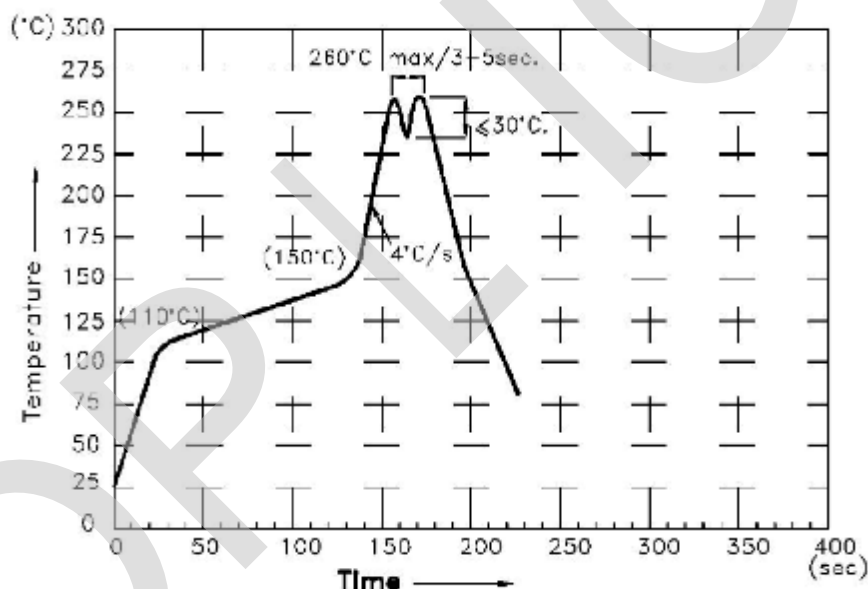

3 . Soldering General Notes:

- Toplight recommend manual soldering to be used only for repair and rework purposes. The soldering iron should not exceed 30W in power. The tip of the soldering iron should not touch the reflector case to avoid heat-damage.
- Maintain the pre-heat and peak temperatures with dip units as low as possible and the times as short as is feasible, since the products are susceptible to heat during flow soldering.
- After soldering, allow at least three minutes for the component to cool to room temperature before further operations.
- If components will undergo multiple soldering processes, or other processes where the components may be subjected to intense heat, please check with Toplight for compatibility.



TECHNICAL DATA SHEET

CC-5461AS <FOR TOPLIGHT 0.56 INCH (14.2mm) FOUR DIGIT>

7/7

PACKING QUANTITY SPECIFICATION

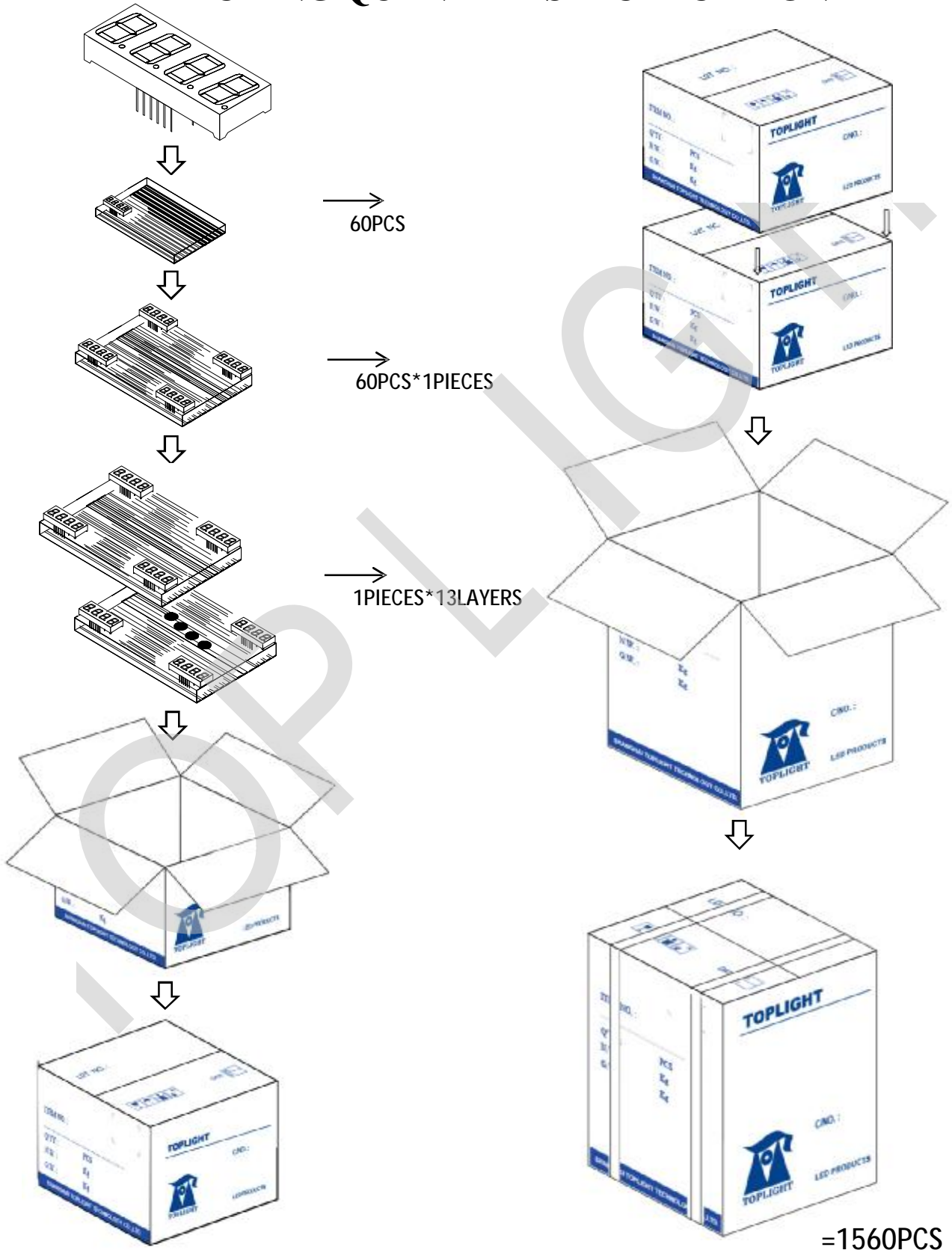

TOPLIGHT