

4 000h at 85°C

· Standard 85°C

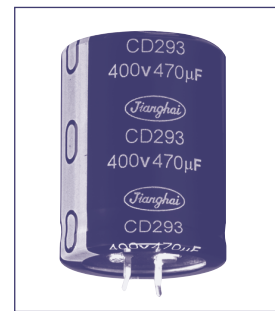
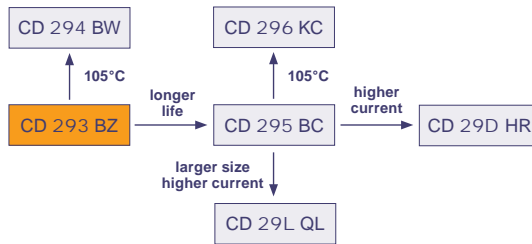

Item	Characteristics																										
Operating Temperature Range (°C)	-40 ~ +85	-25 ~ +85																									
Voltage Range (V)	10 ~ 400	450 ~ 500																									
Capacitance Range (µF)	68 ~ 82 000																										
Capacitance Tolerance (20°C, 120Hz)	± 20%																										
Leakage Current (µA)	After 5 minutes at 20°C application of rated voltage, leakage current is not more than 0,01CV or 1,5mA, whichever is smaller C: Nominal Capacitance (µF) V: Rated Voltage (V)																										
Dissipation Factor (20°C, 120Hz)	Rated Voltage (V) \ Cap (µF)	<table border="1"> <tr> <td>10~16</td> <td>25</td> <td>35~50</td> <td>63</td> <td>80~100</td> </tr> <tr> <td>≤ 2700</td> <td>-</td> <td>-</td> <td>0,20</td> <td>0,15</td> </tr> <tr> <td>3300 ~ 4700</td> <td>-</td> <td>0,35</td> <td>0,25</td> <td>0,20</td> </tr> <tr> <td>5600 ~ 6800</td> <td>0,40</td> <td>0,35</td> <td>0,30</td> <td>0,20</td> </tr> <tr> <td>≥ 8200</td> <td>0,40</td> <td>0,35</td> <td>0,35</td> <td>0,25</td> </tr> </table>	10~16	25	35~50	63	80~100	≤ 2700	-	-	0,20	0,15	3300 ~ 4700	-	0,35	0,25	0,20	5600 ~ 6800	0,40	0,35	0,30	0,20	≥ 8200	0,40	0,35	0,35	0,25
	10~16	25	35~50	63	80~100																						
	≤ 2700	-	-	0,20	0,15																						
	3300 ~ 4700	-	0,35	0,25	0,20																						
5600 ~ 6800	0,40	0,35	0,30	0,20																							
≥ 8200	0,40	0,35	0,35	0,25																							
	Rated Voltage (V) \ Ø (mm)	<table border="1"> <tr> <td>160~200</td> <td>250~500</td> </tr> <tr> <td>22 ~33</td> <td>0,10</td> </tr> <tr> <td>35</td> <td>0,12</td> </tr> </table>	160~200	250~500	22 ~33	0,10	35	0,12																			
160~200	250~500																										
22 ~33	0,10																										
35	0,12																										
	Rated Voltage (V)	<table border="1"> <tr> <td>10</td> <td>10~35</td> <td>50~100</td> <td>160~200</td> <td>250~400</td> <td>450~500</td> </tr> <tr> <td>Z_{-25°C} / Z_{+20°C}</td> <td>5</td> <td>4</td> <td>3</td> <td>4</td> <td></td> </tr> <tr> <td>Z_{-40°C} / Z_{+20°C}</td> <td>18</td> <td>15</td> <td>10</td> <td>6</td> <td>8</td> </tr> </table>	10	10~35	50~100	160~200	250~400	450~500	Z _{-25°C} / Z _{+20°C}	5	4	3	4		Z _{-40°C} / Z _{+20°C}	18	15	10	6	8							
10	10~35	50~100	160~200	250~400	450~500																						
Z _{-25°C} / Z _{+20°C}	5	4	3	4																							
Z _{-40°C} / Z _{+20°C}	18	15	10	6	8																						

	Useful Life		Load Life	Endurance Test	Shelf Life
Lifetime	4 000h	>75000h	2000h	3000h	1 000h
Leakage Current	Not more than specified value		Not more than specified value	Not more than specified value	Not more than specified value
Capacity Change	Within ± 30% of initial value		Within ± 15% of initial value	Within ± 20% of initial value	Within ± 15% of initial value
Dissipation Factor	Not more than 300% of specified value		Not more than 150% of specified value	Not more than 130% of specified value	Not more than 150% of specified value
Condition:					
Applied Voltage	U _R	U _R	U _R	U _R	U _R = 0
Applied Current	I _R	1,2 x I _R	I _R	I _R = 0	I _R = 0
Applied Temperature	85°C	40°C	85°C	85°C	85°C
Failure Rate Level	≤ 1% Failure Rate	≤ 1% Failure Rate	guaranteed		After test: U _R to be applied for 30min >24h before measurement

Multiplier for Ripple Current

Frequency Coefficient

Rated Voltage (V)	Frequency				
	50Hz	120Hz	1kHz	10kHz	100kHz
≤ 50	0,95	1,00	1,10	1,15	1,15
63 ~ 100	0,95	1,00	1,16	1,30	1,33
≥ 160	0,95	1,00	1,20	1,50	1,55

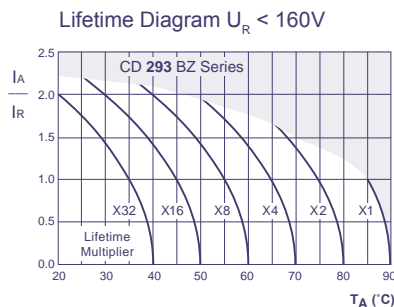

I_A = actual ripple current at 120Hz,
I_R = rated ripple current at 120Hz, 85°C
Multiplier of Useful Life as a function of ambient temperature and ripple current load

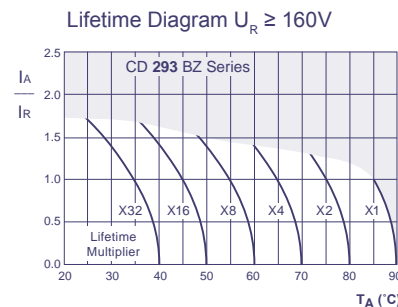

I_A = actual ripple current at 120Hz,
I_R = rated ripple current at 120Hz, 85°C
Multiplier of Useful Life as a function of ambient temperature and ripple current load

Ratings for CD 293 BZ Series

V _{DC} (Surge Voltage) Code	Rated Capa- cittance	Max ESR 20°C, 120Hz	Typ ESR 20°C, 120Hz	Max Ripple Current 85°C, 120Hz	Size Ø D x L	
(V)	(µF)	(mΩ)	(mΩ)	(Arms)	(mm)	
10 (13) 1A	10000	54	43	2.5	22 x 25	
	12000	45	36	2.9	22 x 25	
	15000	36	29	3.2	22 x 30	
		36	29	3.1	25 x 25	
	18000	30	24	3.6	22 x 35	
		30	24	3.6	25 x 30	
	22000	25	20	4.0	22 x 40	
		25	20	4.1	25 x 35	
	33000	17	13	4.6	30 x 25	
		17	13	4.8	30 x 30	
	39000	17	13	4.8	35 x 25	
		14	10.9	5.2	25 x 45	
	47000	14	10.9	5.3	30 x 35	
		12	9.1	5.8	25 x 50	
	56000	12	9.1	6.0	30 x 40	
		12	9.1	6.0	35 x 30	
	68000	9.5	7.6	6.7	30 x 45	
		9.5	7.6	6.8	35 x 35	
16 (20) 1C	82000	7.9	6.3	7.5	30 x 50	
	82000	7.9	6.3	7.7	35 x 40	
	8200	6.5	5.2	8.7	35 x 45	
	10000	65	52	2.2	22 x 25	
		54	43	2.6	22 x 30	
	12000	54	43	2.6	25 x 25	
		45	36	2.9	22 x 35	
	15000	36	29	3.3	22 x 40	
		36	29	3.3	25 x 30	
	18000	36	29	3.4	30 x 25	
		30	24	3.8	22 x 45	
	22000	30	24	3.7	25 x 35	
		25	20	4.2	22 x 50	
	27000	25	20	4.2	25 x 40	
		25	20	4.2	30 x 30	
	33000	25	20	4.4	35 x 25	
		20	16	5.0	25 x 45	
	39000	20	16	5.0	30 x 35	
17		13	5.6	30 x 40		
47000	17	13	5.6	35 x 30		
	14	11	6.2	30 x 45		
56000	14	11	6.3	35 x 35		
	12	9.1	7.0	30 x 50		
68000	12	9.1	7.2	35 x 40		
	9.5	7.6	8.0	35 x 45		
25 (32) 1E	5600	83	67	2.0	22 x 25	
	6800	69	55	2.3	22 x 30	
	8200	69	55	2.3	25 x 25	
		57	46	2.6	22 x 35	
	10000	47	38	2.9	22 x 40	
		47	38	2.8	25 x 30	
	12000	47	38	3.0	30 x 25	
		39	31	3.3	22 x 45	
	15000	39	31	3.2	25 x 35	
		39	31	3.4	30 x 30	
	18000	31	25	3.7	25 x 40	
		31	25	3.9	35 x 25	
	22000	26	21	4.3	25 x 50	
		26	21	4.2	30 x 35	
	33000	26	21	4.4	35 x 30	
		22	17	4.8	30 x 40	
	39000	22	17	5.0	35 x 35	
		15	12	6.5	35 x 40	
	3300	12	10	7.5	35 x 45	
		100	81	1.8	22 x 25	
	35 (44) 1V	3900	86	69	2.1	22 x 30
		4700	71	57	2.2	25 x 25
		5600	72	57	2.3	22 x 35
			72	57	2.3	25 x 30
6800		59	47	2.9	22 x 40	
		59	47	2.6	25 x 35	
8200		59	47	2.7	30 x 25	
		57	46	2.8	22 x 50	
10000		57	46	2.8	25 x 40	
		57	46	2.8	30 x 30	
12000		57	46	2.9	35 x 25	
		47	38	3.1	25 x 45	
15000		47	38	3.2	30 x 35	
		39	31	3.5	25 x 50	
18000		39	31	3.5	30 x 40	
		39	31	3.6	35 x 30	
22000		31	25	4.1	30 x 45	
		31	25	4.1	35 x 35	
27000		26	21	4.6	30 x 50	
		26	21	4.7	35 x 40	
39000		22	17	5.3	35 x 45	
		18	14	7.0	35 x 50	
50 (63) 1H		2200	120	97	1.7	22 x 25
		2700	100	79	1.9	22 x 30
	100		79	1.9	25 x 25	
	3300	100	81	2.0	22 x 35	
		86	69	2.1	22 x 35	
	3900	86	69	2.1	25 x 30	
	86	69	2.4	30 x 25		

V _{DC} (Surge Voltage) Code	Rated Capa- cittance	Max ESR 20°C, 120Hz	Typ ESR 20°C, 120Hz	Max Ripple Current 85°C, 120Hz	Size Ø D x L
(V)	(µF)	(mΩ)	(mΩ)	(Arms)	(mm)
50 (63) 1H	4700	71	57	2.4	22 x 40
		71	57	2.4	25 x 35
		71	57	2.4	30 x 30
	5600	72	57	2.5	22 x 50
		72	57	2.5	25 x 40
		72	57	2.5	30 x 30
		72	57	2.6	35 x 25
	6800	59	47	2.8	25 x 45
		59	47	2.8	30 x 35
		57	46	3.2	25 x 50
	8200	57	46	3.0	30 x 40
		57	46	3.0	35 x 30
		57	46	3.0	35 x 30
	10000	47	38	3.4	30 x 45
		47	38	3.4	35 x 35
	12000	39	31	3.8	30 x 50
	15000	39	31	3.8	35 x 40
	15000	31	25	4.5	35 x 50
1800	135	107	1.6	22 x 25	
1800	110	89	1.8	22 x 30	
2200	91	73	2.0	22 x 30	
2700	91	73	2.0	25 x 25	
	74	59	2.2	22 x 35	
3300	74	59	2.3	25 x 30	
	81	65	2.3	22 x 40	
3900	81	65	2.3	25 x 35	
	81	65	2.3	30 x 25	
4700	69	55	2.5	22 x 45	
	69	55	2.6	25 x 40	
5600	69	55	2.6	30 x 30	
	69	55	2.7	35 x 25	
6800	57	46	2.8	30 x 30	
	48	38	3.1	25 x 45	
8200	48	38	3.2	30 x 35	
	48	38	3.3	35 x 30	
10000	40	32	3.6	30 x 40	
	40	32	3.7	35 x 35	
12000	41	33	3.7	30 x 50	
	41	33	3.8	35 x 40	
10000	34	27	4.3	35 x 45	
12000	28	23	4.8	35 x 50	
1000	200	160	1.3	22 x 25	
1200	165	133	1.5	22 x 30	
1500	133	107	1.7	25 x 25	
1800	111	89	1.9	22 x 35	
	111	89	1.9	25 x 30	
2200	91	73	2.1	22 x 40	
	91	73	2.2	25 x 35	
2700	91	73	2.2	30 x 25	
	74	59	2.5	22 x 50	
3300	74	59	2.5	25 x 40	
	74	59	2.5	30 x 30	
3900	74	59	2.5	35 x 25	
	61	49	2.8	25 x 45	
4700	61	49	2.8	30 x 35	
	61	49	3.1	25 x 50	
5600	52	41	3.1	30 x 40	
	52	41	3.2	30 x 40	
6800	52	41	3.2	35 x 30	
	43	34	3.6	30 x 45	
8200	43	34	3.6	35 x 35	
	48	38	3.5	30 x 50	
10000	48	38	3.5	35 x 40	
	40	32	4.1	35 x 50	
12000	680	293	235	1.1	22 x 25
	820	243	195	1.2	22 x 30
1000	200	160	1.4	25 x 25	
1200	166	133	1.6	22 x 35	
	166	133	1.6	25 x 30	
1500	133	107	1.8	22 x 40	
	133	107	1.7	25 x 35	
1800	133	107	1.8	30 x 25	
	111	89	2.1	22 x 50	
2200	111	89	2.0	25 x 40	
	111	89	2.1	30 x 30	
2700	111	89	2.2	35 x 25	
	91	73	2.2	25 x 45	
3300	91	73	2.3	30 x 35	
	91	73	2.5	35 x 30	
3900	74	59	2.6	25 x 50	
	74	59	2.7	30 x 40	
4700	61	49	3.0	30 x 45	
	61	49	3.1	35 x 35	
5600	52	41	3.4	30 x 50	
	52	41	3.4	35 x 40	
6800	43	34	4.0	35 x 50	
	220	600	483	1.1	22 x 25
7700	270	490	393	1.2	22 x 25
	330	400	322	1.3	22 x 25
8900	341	273	1.5	22 x 30	
	341	273	1.5	25 x 25	
10000	283	226	1.6	25 x 30	
	237	190	1.9	22 x 35	
11000	237	190	1.9	25 x 30	
	237	190	2.0	30 x 25	

Snap-In

Ratings for CD 293 BZ Series

V _{DC} (Surge Voltage) Code	Rated Capacitance	Max ESR 20°C, 120Hz	Typ ESR 20°C, 120Hz	Max Ripple Current 85°C, 120Hz	Size Ø D x L
(V)	(µF)	(mΩ)	(mΩ)	(Arms)	(mm)
160 (200) 2C	680	196	157	2.1	22 x 40
		196	157	2.2	25 x 35
	820	162	130	2.5	22 x 50
		162	130	2.4	25 x 40
		162	130	2.5	30 x 30
		195	156	2.4	35 x 25
	1000	133	107	2.7	25 x 45
		133	107	2.8	30 x 35
		160	128	2.7	35 x 30
	1200	111	89	3.1	25 x 50
		111	89	3.2	30 x 40
		133	107	3.0	35 x 35
		89	71	3.7	30 x 45
	1500	107	85	3.5	35 x 40
		89	71	3.9	35 x 45
	2200	73	58	4.5	35 x 50
180 (225) 2K	270	495	393	1.2	22 x 25
	330	400	322	1.4	22 x 30
	390	340	273	1.5	25 x 25
	470	283	226	1.7	22 x 35
		283	226	1.7	25 x 30
	560	283	226	1.8	30 x 25
		237	190	1.9	22 x 40
	680	237	190	2.0	25 x 35
		196	157	2.3	22 x 50
		196	157	2.2	25 x 40
		196	157	2.3	30 x 30
	820	235	188	2.2	35 x 25
		162	130	2.5	25 x 45
		162	130	2.6	30 x 35
		195	156	2.5	35 x 30
	1000	133	107	2.9	25 x 50
		133	107	2.9	30 x 40
		111	89	3.3	30 x 45
		133	107	3.1	35 x 35
	1500	107	85	3.6	35 x 45
89		71	4.1	35 x 50	
200 (250) 2D	220	600	483	1.1	22 x 25
	270	492	393	1.2	22 x 30
	330	402	322	1.4	22 x 30
	390	402	322	1.4	25 x 25
		341	273	1.6	22 x 35
	470	341	273	1.6	25 x 30
		283	226	1.8	22 x 40
	560	283	226	1.9	30 x 25
		237	190	2.0	22 x 45
		237	190	2.0	25 x 35
		237	190	2.1	30 x 30
	680	285	228	2.0	35 x 25
		196	157	2.3	25 x 40
		196	157	2.4	30 x 35
		162	130	2.6	25 x 50
	820	162	130	2.7	30 x 40
		195	156	2.5	35 x 30
		133	107	3.1	30 x 45
		160	128	2.8	35 x 35
	1000	111	89	3.4	30 x 50
133		107	3.2	35 x 40	
1500		107	85	3.8	35 x 50
250 (300) 2E		100	1990	1592	0.68
	180	1106	885	0.94	22 x 25
	220	905	724	1.1	22 x 30
		905	724	1.1	25 x 25
	270	737	590	1.2	22 x 35
		603	483	1.4	22 x 40
	330	603	483	1.4	25 x 30
		603	483	1.5	30 x 25
		511	409	1.6	22 x 45
	390	511	409	1.6	25 x 35
		424	339	1.8	22 x 50
	470	424	339	1.8	25 x 40
		424	339	1.8	30 x 30
		424	339	2.4	35 x 25
		356	285	2.0	25 x 45
	560	356	285	2.0	30 x 35
		293	235	2.3	30 x 40
	680	293	235	2.6	35 x 30
		243	195	2.6	30 x 45
	820	243	195	2.6	35 x 35
199		160	3.0	35 x 40	
1200	166	133	3.4	35 x 45	
315 (365) 2F	100	1990	1592	0.67	22 x 25
	150	1327	1062	0.85	22 x 30
		1327	1062	0.85	25 x 25
	180	1106	885	0.96	22 x 35
		1106	885	0.96	25 x 30
	220	905	724	1.1	22 x 40
		905	724	1.1	25 x 35
		905	724	1.1	30 x 25
		737	590	1.2	22 x 45
	270	737	590	1.3	25 x 40
		737	590	1.3	30 x 30
		737	590	1.3	30 x 30
		737	590	1.3	35 x 25

V _{DC} (Surge Voltage) Code	Rated Capacitance	Max ESR 20°C, 120Hz	Typ ESR 20°C, 120Hz	Max Ripple Current 85°C, 120Hz	Size Ø D x L	
(V)	(µF)	(mΩ)	(mΩ)	(Arms)	(mm)	
315 (365) 2F	330	603	483	1.4	25 x 45	
		603	483	1.4	30 x 35	
	390	511	409	1.6	25 x 50	
		511	409	1.6	30 x 40	
		511	409	1.6	35 x 30	
		424	339	1.8	30 x 45	
	470	424	339	1.8	35 x 35	
		356	285	2.0	30 x 50	
	560	356	285	2.0	35 x 40	
		680	293	235	2.3	35 x 45
	680	82	2427	1941	0.64	22 x 25
		100	1990	1592	0.80	22 x 25
		120	1658	1327	0.82	22 x 30
			1658	1327	0.81	25 x 25
	150	1327	1062	0.94	22 x 35	
		1327	1062	0.94	25 x 30	
1106		885	1.1	22 x 40		
1106		885	1.1	30 x 25		
220	905	724	1.2	22 x 45		
	905	724	1.2	25 x 35		
	905	724	1.2	30 x 30		
	905	724	1.3	35 x 25		
270	737	590	1.4	25 x 45		
	737	590	1.4	30 x 35		
	603	483	1.6	25 x 50		
	603	483	1.6	35 x 30		
390	511	409	1.7	30 x 40		
	511	409	1.8	35 x 35		
	424	339	2.0	30 x 45		
	424	339	2.0	35 x 40		
560	356	285	2.3	35 x 45		
	680	293	235	2.6	35 x 50	
	820	243	195	2.8	35 x 60	
	68	2926	2341	0.55	22 x 25	
820	2427	1941	0.65	22 x 25		
	1990	1592	0.70	22 x 30		
	1990	1592	0.70	25 x 25		
	120	1658	1327	0.79	22 x 35	
150	1327	1062	0.90	22 x 40		
	1327	1062	0.89	25 x 30		
	1327	1062	0.95	30 x 25		
	1106	885	1.0	22 x 45		
180	1106	885	1.0	25 x 35		
	1106	885	1.1	30 x 30		
	1106	885	1.2	35 x 25		
	905	724	1.1	22 x 50		
220	905	724	1.2	25 x 40		
	905	724	1.2	30 x 35		
	737	590	1.3	25 x 45		
	737	590	1.4	30 x 40		
270	737	590	1.5	35 x 30		
	603	483	1.6	30 x 45		
	603	483	1.7	35 x 35		
	511	409	1.8	30 x 50		
390	511	409	1.8	35 x 40		
	424	339	2.1	35 x 45		
	560	356	285	2.3	35 x 50	
	68	2926	2341	0.57	22 x 30	
820	2427	1941	0.68	22 x 35		
	1990	1592	0.72	22 x 35		
	1990	1592	0.73	25 x 30		
	120	1658	1327	0.80	22 x 40	
150	1658	1327	0.83	25 x 35		
	1327	1062	0.95	22 x 50		
	1327	1062	0.95	25 x 40		
	1327	1062	0.98	30 x 30		
180	1106	885	1.1	25 x 45		
	1106	885	1.1	30 x 35		
	1106	885	1.2	35 x 25		
	905	724	1.2	25 x 50		
220	905	724	1.2	30 x 40		
	905	724	1.3	35 x 30		
	737	590	1.4	30 x 45		
	737	590	1.5	35 x 35		
270	737	590	1.5	35 x 50		
	603	483	1.7	30 x 50		
	511	409	1.9	35 x 45		
	470	424	339	2.2	35 x 50	
390	100	1990	1592	0.90	30 x 25	
	120	1658	1327	1.0	30 x 30	
	150	1327	1062	1.0	35 x 25	
	150	1327	1062	1.2	30 x 35	
500 (550) 2H	180	1106	885	1.4	30 x 40	
	1106	885	1.3	35 x 30		
	905	724	1.6	30 x 45		
	905	724	1.5	35 x 35		
220	905	724	1.5	35 x 35		
	737	590	1.8	30 x 50		
270	737	590	1.7	35 x 40		
	330	603	483	2.0	35 x 45	
390	511	409	2.3	35 x 50		

Custom products are available on request.

Order Code SMD, Radial, Snap-In

EC	R	1C	PT	101	M	FF	25	0611	JE xxxxx
Technology	Terminal Type	Rated Voltage Code	Series Code	Capacitance Code (in μF)	Capacitance Tolerance	Lead Form	Terminal/Pitch Size	Dimension	for Specials only
EC = Electrolytic Capacitor	SMD = V	For coding please refer to the pages of ratings	CD VS = BS	0,47 = R47	$\pm 20\%$ = M	SMD:		4x7 = 0407	
	Radial = R		CD VH = VH	1,0 = 010	$\pm 10\%$ = K	Taped = FF	Terminal = T2	5x11,5 = 0511	
PC = Polymer Capacitor	Snap-In = S		CD VZ = VZ	2,2 = 2R2	+30 / -10% = Q	Radial:		6,3x11,5 = 0611	
			CD 261 = LK	100 = 101	+50 / -10% = T	Long Lead = LL	2,0mm = 20	35x80 = 3580	
			CD 261X = QX	1000 = 102		Cut 5,0mm = CB	2,5mm = 25	45x100 = 45100	
			CD 262 = QM	10000 = 103		Cut 4,5mm = CC	3,5mm = 35		
			CD 263 = BK			Cut 4,0mm = CD	5,0mm = 50		
			CD 269 = PH			Cut 3,5mm = CE	7,5mm = 75		
			CD 281 = LL			Cut 3,0mm = CF	10,0mm = 10		
			CD 284 = XY			on request: alternative lead forms (axial, 90° - angle, others)		12,5mm = 12	
		CD 287 = GC			Snap-In:				
		CD 28L = QL			4,0mm Pin Length = T4	2 Pin = P2			
		CD 293 = BZ			6,3mm Pin Length = T6	3 Pin = P3			
		CD 294 = BW			Soldering Pin = S4	4 Pin = P4			
		CD 295 = BC				5 Pin = P5			
		CD 296 = KC			preferred				
		CD 297 = BB							
		CD 299 = PG							
		CD 29D = HR							
		CD 29H = QH							
		CD 29L = QL							
		HCP = CP							
		HPM = PM							
		HVC = VC							

Technical Specification SMD Type

Dimensions

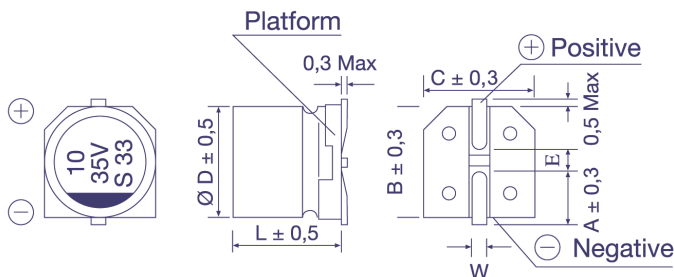

Ø D x L	4x5,4	5x5,4	6,3x5,4	6,3x7,7	8x10,5	8x11,8	10x10,5	10x12,7
A	1,8	2,1	2,4	2,5	2,9	2,9	3,2	3,2
B	4,3	5,3	6,6	6,6	8,3	8,4	10,3	10,4
C	4,3	5,3	6,6	6,6	8,3	8,4	10,3	10,4
E	1,0	1,3	2,2	2,2	3,1	3,1	4,5	4,5
L	5,4	5,4	5,4	7,7	10,5	11,8	10,5	12,7
W	0,5 - 0,8				0,7 - 1,1			

in mm

Taping Dimensions

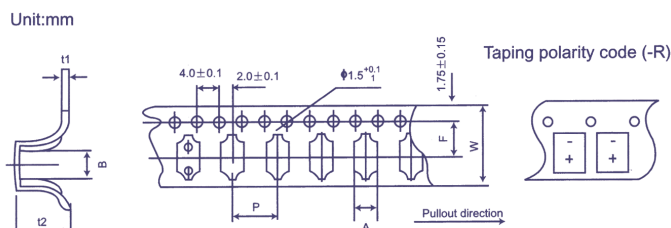

Size (DxL)	w ± 0,3	A ± 0,2	B ± 0,2	P ± 0,1	t2 ± 0,2	F ± 0,1	t1 ± 0,1
4 x 5,4	12,0	5,0	5,0	8,0	5,8	5,5	0,4
5 x 5,4	12,0	6,0	6,0	12,0	5,8	5,5	0,4
6,3 x 5,4	16,0	7,0	7,0	12,0	5,8	7,5	0,4
6,3 x 7,7	16,0	7,0	7,0	12,0	8,4	7,5	0,4
8 x 10,5	24,0	8,7	8,7	16,0	11,0	11,5	0,5
8 x 11,8	24,0	8,7	8,7	16,0	12,3	11,5	0,5
10 x 10,5	24,0	10,7	10,7	16,0	11,0	11,5	0,5
10 x 12,7	24,0	10,7	10,7	16,0	14,0	11,5	0,5

in mm

Soldering Profile (Aluminium Electrolytic Capacitors)

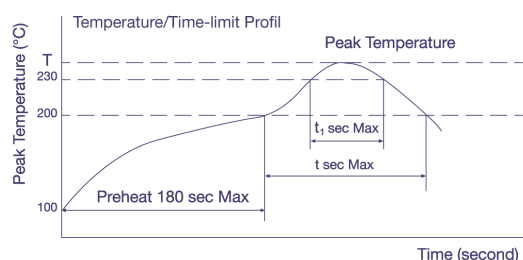

Allowable Range of Peak Temperature

Size	T (°C)	t (second)	t ₁ (second)
Ø 4 ~ 6,3	250	90	40
Ø 8 x 10,5	240	90	30
Ø 10 x 10,5	235	60	30

Diameter	w	D
4; 5	14 ± 1	50 ± 1
6,3	18 ± 1	50 ± 1
8; 10	25 ± 1	50 ± 1
Polymer	25 ± 1	80 ± 1

in mm

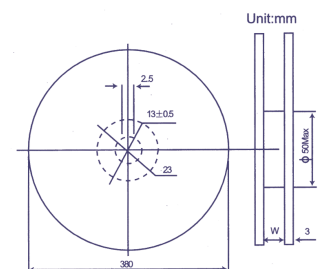

For more details or Soldering Profiles of Radials or Polymer-Capacitors please contact our local Sales Offices.

Technical Specification Snap-In Type

Pin Type: Snap-In
Order Code: T6, T4

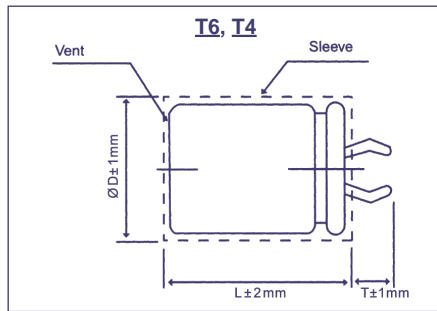

Terminal	T6	T4
Pin Length T	6,3	4,0

Pin Type: Soldering
Order Code: S4

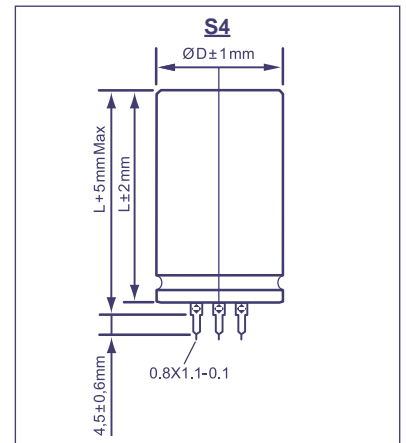

Snap-In Terminal
Order Code: P2, P3, P4

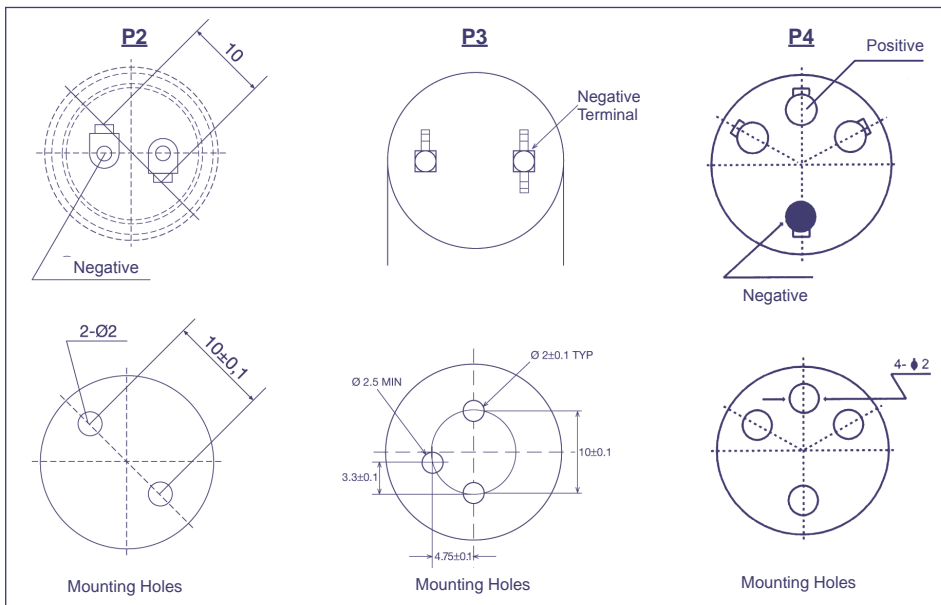

Soldering Terminal
Order Code: P5

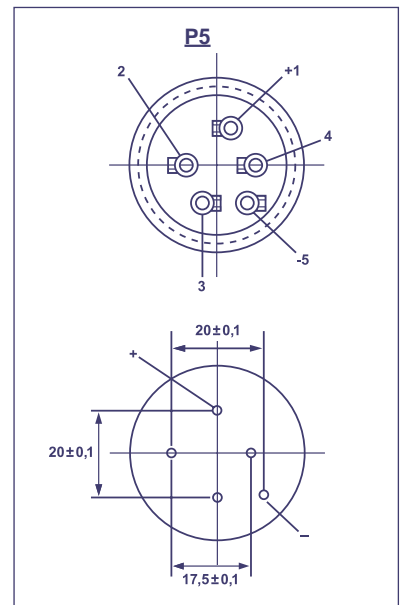

P3 only T4 Terminal

Order Code Screw Type

EC	G	1C	BP	101	M	B	E	160	A361	JExxxxx
Technology	Terminal Type	Rated Voltage Code	Series Code	Capacitance Code	Capacitance Tolerance	Mounting	Diameter	Length	For Terminal Code see tables below	for Specials only
EC = Electrolytic Capacitor	Screw = G	For coding please refer to the pages of ratings	CD 135 = BP	100 = 101	±20% = M	Bolt = B	36 = A	53 = 053		
			CD 136 = PK	1000 = 102	±10% = K	No double sleeve = N	40 = B	65 = 065		
			CD 137 = PX	10000 = 103	+30 / -10% = Q	2 stoppers bracket+double sleeve* = I	51 = C	96 = 096		
			CD 138 = PC		+20 / -0% = R	3 stoppers bracket+double sleeve* = Y	64 = D	100 = 100		
			CD 139 = BL		+50 / -10% = T	No bracket, but double sleeve* = D	77 = E	115 = 115		
				preferred	* Double sleeve for diameter ≥ 51 only		90 = F	236 = 236		
							101 = G			

Technical Specification Screw Type

Dimensions

Standard Housing
Order Code: I, Y, D, N

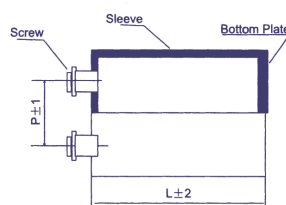
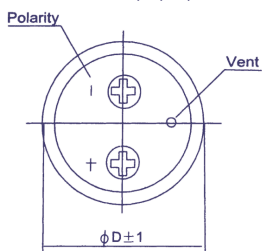

Bolt Housing
Order Code: B

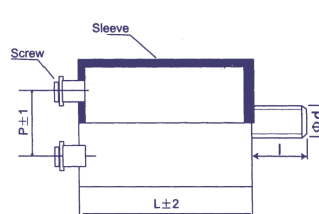

Ø D	Ø d	l
Ø 36	M8	12
≥ Ø 51	M12	16

in mm