

7000h at 105°C

- Extended Lifetime at 105°C
- High Ripple Current
- High Professional Switch Mode Power Supplies
- Frequency Converters

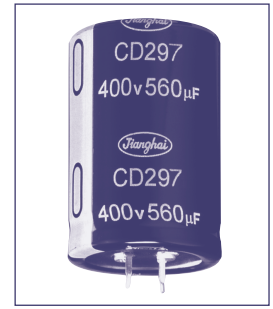
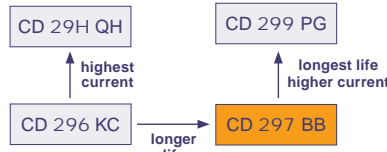

Item	Characteristics	
Operating Temperature Range (°C)	-40 ~ +105	-25 ~ +105
Voltage Range (V)	10 ~ 100	160 ~ 450
Capacitance Range (µF)	68 ~ 56000	
Capacitance Tolerance (20°C, 120Hz)	± 20%	
Leakage Current (µA)	After 5 minutes at 20°C application of rated voltage, leakage current is not more than 0,01CV or 1,5mA, whichever is smaller C: Nominal Capacitance (µF) V: Rated Voltage (V)	
Dissipation Factor (20°C, 120Hz)	Rated Voltage (V)	10 16 25 35 50 63 80 100 160~250 315~400 450
	Tan δ (max)	0,55 0,50 0,45 0,40 0,35 0,30 0,25 0,20 0,15 0,20 0,25
Stability at Low Temperature (Impedance Ratio at 120Hz)	Rated Voltage (V)	10 ~ 100 160 ~ 250 350 ~ 450
	Z _{-25°C} / Z _{+20°C}	4 3 8
	Z _{-40°C} / Z _{+20°C}	15 - -

	Useful Life		Load Life	Endurance Test	Shelf Life
Lifetime	7 000h	>200 000h	5 000h	5 000h	1 000h
Leakage Current	Not more than specified value		Not more than specified value	Not more than specified value	Not more than specified value
Capacity Change	Within ± 30% of initial value		Within ± 20% of initial value	Within ± 20% of initial value	Within ± 20% of initial value
Dissipation Factor	Not more than 300% of specified value		Not more than 200% of specified value	Not more than 130% of specified value	Not more than 200% of specified value
Condition: Applied Voltage Applied Current Applied Temperature Failure Rate Level	U _R I _R 105°C ≤ 1% Failure Rate	U _R 1,6 x I _R 40°C ≤ 1% Failure Rate	U _R I _R 105°C guaranteed	U _R I _R = 0 105°C	U _R = 0 I _R = 0 105°C After test: U _R to be applied for 30min >24h before measurement

Multiplier for Ripple Current

Frequency Coefficient

Rated Voltage (V)	Frequency				
	50Hz	120Hz	500Hz	1kHz	≥10kHz
10 ~ 100	0,90	1,00	1,05	1,10	1,15
160 ~ 250	0,80	1,00	1,20	1,30	1,50
315 ~ 450	0,80	1,00	1,20	1,25	1,40

Lifetime Diagram

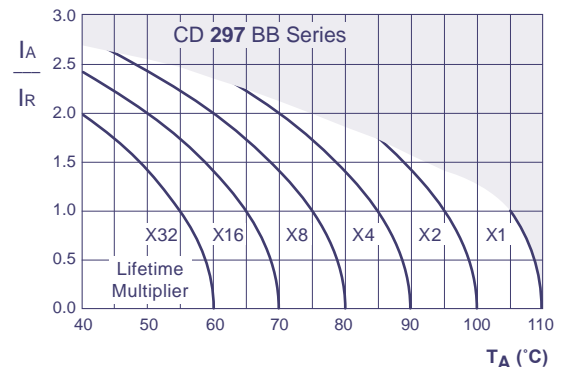

I_A = actual ripple current at 120Hz, I_R = rated ripple current at 120Hz, 105°C
Multiplier of Useful Life as a function of ambient temperature and ripple current load

Ratings for CD 297 BB Series

V _{DC} (Surge Voltage) Code	Rated Capacitance	Max ESR 20°C, 120Hz	Typ ESR 20°C, 120Hz	Max Ripple Current 105°C, 120Hz	Size Ø D x L
(V)	(µF)	(mΩ)	(mΩ)	(Arms)	(mm)
10 (13) 1A	8200	89	63	1,36	22 x 25
	10000	73	52	1,65	22 x 30
	12000	61	43	1,85	22 x 35
		61	43	1,82	25 x 25
	15000	49	35	2,12	22 x 40
		49	35	2,11	25 x 30
	18000	49	35	2,14	30 x 25
		41	29	2,40	22 x 45
	22000	41	29	2,32	25 x 35
		34	24	2,59	25 x 40
	27000	34	24	2,73	30 x 30
		27	19	3,01	25 x 45
		27	19	3,13	30 x 35
	33000	27	19	3,05	35 x 30
		23	16	3,43	25 x 50
		23	16	3,53	30 x 40
	39000	23	16	3,49	35 x 35
		19	14	3,78	30 x 45
16 (20) 1C	19	14	3,96	35 x 40	
	47000	16	11	4,58	30 x 50
	56000	16	11	4,60	35 x 45
	56000	14	10	5,06	35 x 50
	5600	119	83	1,44	22 x 25
	6800	98	69	1,66	22 x 30
	8200	81	57	1,67	25 x 25
	10000	67	47	2,08	22 x 35
		67	47	2,07	25 x 30
	12000	56	39	2,36	22 x 40
		56	39	2,37	25 x 35
	15000	56	39	2,13	30 x 25
		45	31	3,69	22 x 45
		45	31	2,72	25 x 40
	18000	45	31	2,54	30 x 30
		37	26	3,06	25 x 45
		37	26	3,02	30 x 35
	22000	37	26	3,09	35 x 30
31		22	3,39	25 x 50	
27000	31	22	3,46	30 x 40	
	25	18	3,88	30 x 45	
33000	25	18	3,85	35 x 35	
	21	15	4,33	30 x 50	
25 (32) 1E	21	15	4,33	35 x 40	
	39000	18	12	4,96	35 x 45
	47000	15	10	5,49	35 x 50
	3900	154	108	1,31	22 x 25
	4700	127	89	1,55	22 x 30
		107	75	1,77	22 x 35
	5600	107	75	1,56	25 x 25
		88	62	2,02	22 x 40
	6800	88	62	1,88	25 x 30
		73	51	2,27	22 x 45
	8200	73	51	2,18	25 x 35
		73	51	1,92	30 x 25
	10000	60	42	2,56	22 x 50
		60	42	2,53	25 x 40
	12000	60	42	2,38	30 x 30
		50	35	2,79	25 x 45
	15000	50	35	2,70	30 x 35
		50	35	2,76	35 x 30
18000	40	28	3,13	30 x 40	
	34	24	3,52	30 x 45	
22000	34	24	3,50	35 x 35	
	28	19	3,92	30 x 50	
27000	28	19	3,95	35 x 40	
	23	16	4,72	35 x 50	
35 (44) 1V	2700	197	138	1,29	22 x 25
	3300	161	113	1,54	22 x 30
	3900	137	96	1,77	22 x 35
		137	96	1,55	25 x 25
	4700	113	80	2,01	22 x 40
		113	80	1,87	25 x 30
	5600	95	67	2,25	22 x 45
		95	67	2,18	25 x 35
	6800	95	67	1,80	30 x 25
		79	55	2,49	22 x 50
	8200	79	55	2,45	25 x 40
		79	55	2,28	30 x 30
	10000	65	46	2,80	25 x 45
		65	46	2,69	30 x 35
	12000	54	38	3,04	30 x 40
		54	38	2,78	35 x 30
	15000	45	31	3,38	30 x 45
		45	31	3,30	35 x 35
18000	36	25	3,88	35 x 40	
18000	30	21	4,40	35 x 45	

V _{DC} (Surge Voltage) Code	Rated Capacitance	Max ESR 20°C, 120Hz	Typ ESR 20°C, 120Hz	Max Ripple Current 105°C, 120Hz	Size Ø D x L
(V)	(µF)	(mΩ)	(mΩ)	(Arms)	(mm)
50 (63) 1H	1500	310	217	1,21	22 x 25
	2200	212	148	1,52	22 x 30
		212	148	1,46	25 x 25
	2700	172	121	1,77	22 x 35
		172	121	1,76	25 x 30
	3300	141	99	2,02	22 x 40
		141	99	1,72	30 x 25
	3900	120	84	2,27	22 x 45
		120	84	2,20	25 x 35
		120	84	2,09	30 x 30
	4700	99	70	2,43	25 x 40
		83	59	2,72	25 x 45
	5600	83	59	2,58	30 x 35
		83	59	2,35	35 x 30
		69	48	3,01	30 x 40
	6800	69	48	2,91	35 x 35
		57	40	3,63	30 x 50
	8200	57	40	3,36	35 x 40
47		33	3,79	35 x 45	
10000	39	28	4,06	35 x 50	
1000	398	279	1,10	22 x 25	
1500	266	186	1,41	22 x 30	
	266	186	1,38	25 x 25	
1800	222	155	1,62	22 x 35	
	222	155	1,63	25 x 30	
2200	181	127	1,85	22 x 40	
	181	127	1,66	30 x 25	
2700	148	104	2,10	22 x 45	
	148	104	2,03	25 x 35	
	148	104	2,01	30 x 30	
3300	121	85	2,33	25 x 40	
	103	72	2,58	25 x 45	
3900	103	72	2,46	30 x 35	
	103	72	2,31	35 x 30	
4700	85	60	2,82	30 x 40	
	85	60	2,77	35 x 35	
5600	72	50	3,22	30 x 45	
	72	50	3,20	35 x 40	
6800	59	41	3,61	35 x 45	
8200	49	34	3,94	35 x 50	
820	405	284	1,09	22 x 25	
1000	332	233	1,29	22 x 30	
1200	277	194	1,48	22 x 35	
	277	194	1,32	25 x 25	
1500	222	155	1,70	22 x 40	
	222	155	1,74	25 x 30	
1800	222	155	1,58	30 x 25	
	185	129	1,91	22 x 45	
2200	185	129	1,86	25 x 35	
	151	106	2,22	25 x 45	
2700	151	106	2,02	30 x 30	
	123	86	2,50	30 x 35	
3300	123	86	2,18	35 x 30	
	101	71	2,69	30 x 40	
3900	101	71	2,60	35 x 35	
	86	60	2,94	30 x 45	
4700	86	60	3,00	35 x 40	
	71	50	3,44	35 x 45	
5600	60	42	3,72	35 x 50	
560	474	332	1,01	22 x 25	
680	391	274	1,19	22 x 30	
	324	227	1,33	22 x 35	
820	324	227	1,26	25 x 25	
	266	186	1,56	22 x 40	
1000	266	186	1,52	25 x 30	
	266	186	1,47	30 x 25	
1200	222	155	1,76	22 x 45	
	222	155	1,76	25 x 35	
1500	222	155	1,76	30 x 30	
	177	124	2,00	22 x 50	
1800	177	124	2,03	25 x 40	
	148	104	2,29	25 x 45	
2200	148	104	2,19	30 x 35	
	148	104	2,05	35 x 30	
2700	121	85	2,52	30 x 40	
	121	85	2,48	35 x 35	
3300	99	69	2,86	30 x 45	
	99	69	2,87	35 x 40	
3900	81	57	3,25	35 x 45	
3900	68	48	3,56	35 x 50	
160 (200) 2C	220	905	634	0,63	22 x 25
	270	737	516	0,76	22 x 30
330	603	423	0,90	22 x 35	
	603	423	0,84	25 x 25	

Custom products are available on request.

V _{DC} (Surge Voltage) Code	Rated Capacitance	Max ESR 20°C, 120Hz	Typ ESR 20°C, 120Hz	Max Ripple Current 105°C, 120Hz	Size Ø D x L
(V)	(µF)	(mΩ)	(mΩ)	(Arms)	(mm)
160 (200) 2C	390	511	358	0,97	25 x 30
		511	358	1,00	30 x 25
		424	297	1,11	22 x 40
	470	424	297	1,14	25 x 35
		424	297	1,17	30 x 30
		356	249	1,26	22 x 45
	560	293	205	1,44	22 x 50
		293	205	1,43	25 x 40
	680	293	205	1,50	30 x 35
		243	170	1,63	25 x 45
		243	170	1,66	30 x 40
	820	243	170	1,63	35 x 30
		199	140	1,89	30 x 45
		199	140	1,89	35 x 35
	1000	166	117	2,16	30 x 50
		166	117	2,23	35 x 40
	1500	133	93	2,61	35 x 45
	1800	111	78	2,97	35 x 50
180 (225) 2K	220	905	634	0,63	22 x 25
		737	516	0,76	22 x 30
	270	737	516	0,76	25 x 25
		603	423	0,90	22 x 35
	330	603	423	0,90	25 x 30
		511	358	1,03	22 x 40
	390	511	358	1,06	25 x 35
		511	358	1,02	30 x 25
		424	297	1,17	22 x 45
	470	424	297	1,17	30 x 30
		356	249	1,32	22 x 50
	560	356	249	1,32	25 x 40
		356	249	1,33	30 x 35
		293	205	1,51	25 x 45
	680	293	205	1,49	35 x 30
		243	170	1,71	25 x 50
	820	243	170	1,74	30 x 40
		243	170	1,75	35 x 35
199		140	2,01	30 x 45	
1000	199	140	2,07	35 x 40	
	166	117	2,25	30 x 50	
	166	117	2,23	35 x 45	
1500	133	93	2,76	35 x 50	
200 (250) 2D	180	1106	774	0,57	22 x 25
		905	634	0,70	22 x 30
		737	516	0,83	22 x 35
	270	737	516	0,76	25 x 25
		603	423	0,96	22 x 40
	330	603	423	0,90	25 x 30
		511	358	1,06	25 x 35
	390	511	358	1,02	30 x 25
		424	297	1,17	22 x 45
		424	297	1,22	25 x 40
	470	424	297	1,17	30 x 30
		356	249	1,39	25 x 45
		356	249	1,38	30 x 35
	560	293	205	1,58	25 x 50
		293	205	1,61	30 x 40
		293	205	1,49	35 x 30
	680	243	170	1,85	30 x 45
		243	170	1,75	35 x 35
199		140	2,11	30 x 50	
820	199	140	2,07	35 x 40	
	166	117	2,38	35 x 45	
	166	117	2,38	35 x 45	
1500	133	93	2,76	35 x 50	
250 (300) 2E	150	1327	929	0,52	22 x 25
		1106	774	0,64	22 x 30
		1106	774	0,62	25 x 25
	180	905	634	0,76	22 x 35
		905	634	0,76	25 x 30
	220	737	516	0,88	22 x 40
		737	516	0,90	25 x 35
		737	516	0,85	30 x 25
	270	603	423	1,01	22 x 45
		603	423	1,00	30 x 30
	330	511	358	1,13	22 x 50
		511	358	1,13	25 x 40
		511	358	1,15	30 x 35
	390	424	297	1,29	25 x 45
		424	297	1,24	35 x 30
		356	249	1,45	25 x 50
	470	356	249	1,48	30 x 40
		356	249	1,49	35 x 35
293		205	1,71	30 x 45	
560	293	205	1,74	35 x 40	
	243	170	1,94	30 x 50	
	243	170	1,94	30 x 50	
1000	199	140	2,20	35 x 45	

V _{DC} (Surge Voltage) Code	Rated Capacitance	Max ESR 20°C, 120Hz	Typ ESR 20°C, 120Hz	Max Ripple Current 105°C, 120Hz	Size Ø D x L
(V)	(µF)	(mΩ)	(mΩ)	(Arms)	(mm)
315 (365) 2F	68	3901	2731	0,32	22 x 25
		3235	2265	0,38	22 x 30
		2653	1857	0,41	25 x 25
	100	2211	1548	0,48	22 x 35
		2211	1548	0,49	25 x 30
		1769	1238	0,56	22 x 40
	120	1769	1238	0,56	22 x 40
		1769	1238	0,51	30 x 25
		1474	1032	0,63	22 x 45
	150	1474	1032	0,62	25 x 35
		1474	1032	0,63	30 x 30
		1206	845	0,72	22 x 50
	180	1206	845	0,71	25 x 40
		1206	845	0,74	30 x 35
		983	688	0,81	25 x 45
	220	983	688	0,85	30 x 40
		983	688	0,75	35 x 30
		804	563	0,92	25 x 50
270	804	563	0,90	35 x 35	
	681	477	1,04	30 x 45	
	681	477	1,05	35 x 40	
330	565	396	1,15	30 x 50	
	565	396	1,18	35 x 45	
	474	332	1,34	35 x 50	
350 (400) 2V	68	3901	2731	0,34	22 x 25
		3235	2265	0,40	22 x 30
		2653	1857	0,47	25 x 25
	100	2211	1548	0,52	22 x 35
		2211	1548	0,53	25 x 30
		1769	1238	0,53	30 x 25
	120	1769	1238	0,59	22 x 40
		1769	1238	0,60	25 x 35
		1474	1032	0,68	22 x 45
	150	1474	1032	0,70	25 x 40
		1474	1032	0,71	30 x 30
		1206	845	0,78	22 x 50
	180	1206	845	0,82	25 x 45
		1206	845	0,82	30 x 35
		983	688	0,94	25 x 50
	220	983	688	0,93	30 x 40
		983	688	0,90	35 x 30
		804	563	1,05	30 x 45
270	804	563	1,01	35 x 35	
	681	477	1,18	30 x 50	
	681	477	1,13	35 x 40	
330	565	396	1,26	35 x 45	
	565	396	1,26	35 x 45	
	474	332	1,39	35 x 50	
400 (450) 2G	68	3901	2731	0,38	22 x 30
		3235	2265	0,41	25 x 25
		2653	1857	0,46	22 x 35
	100	2653	1857	0,48	25 x 30
		2653	1857	0,48	30 x 25
		2211	1548	0,53	22 x 40
	120	2211	1548	0,55	25 x 35
		2211	1548	0,56	30 x 30
		1769	1238	0,63	22 x 50
	150	1769	1238	0,65	25 x 40
		1474	1032	0,72	25 x 45
		1474	1032	0,74	30 x 35
	180	1474	1032	0,74	30 x 35
		1206	845	0,79	25 x 50
		1206	845	0,85	30 x 40
	220	1206	845	0,89	35 x 30
		1206	845	0,89	35 x 30
		983	688	0,98	30 x 45
270	983	688	0,96	35 x 35	
	983	688	0,96	35 x 35	
	804	563	1,12	30 x 50	
330	804	563	1,12	35 x 40	
	681	477	1,27	35 x 45	
	681	477	1,27	35 x 45	
450 (500) 2W	68	4879	3415	0,38	22 x 30
		4046	2832	0,44	22 x 35
		4046	2832	0,45	25 x 30
	82	4046	2832	0,46	30 x 25
		3318	2323	0,50	22 x 40
		3318	2323	0,52	25 x 35
	100	2765	1936	0,58	22 x 50
		2765	1936	0,58	25 x 40
		2765	1936	0,58	30 x 30
	120	2212	1549	0,66	25 x 45
		2212	1549	0,66	25 x 45
		2212	1549	0,68	30 x 35
	150	1844	1291	0,74	25 x 50
		1844	1291	0,77	30 x 40
		1844	1291	0,77	35 x 30
	180	1508	1056	0,88	30 x 45
		1508	1056	0,88	35 x 35
		1229	861	0,99	30 x 50
220	1229	861	0,99	30 x 50	
	1229	861	1,01	35 x 40	
	1006	704	1,15	35 x 45	
270	1006	704	1,15	35 x 45	
	851	596	1,28	35 x 50	
	851	596	1,28	35 x 50	

Snap-In

Custom products are available on request.

Order Code SMD, Radial, Snap-In

EC	R	1C	PT	101	M	FF	25	0611	JE xxxxx
Technology	Terminal Type	Rated Voltage Code	Series Code	Capacitance Code (in μF)	Capacitance Tolerance	Lead Form	Terminal/Pitch Size	Dimension	for Specials only
EC = Electrolytic Capacitor	SMD = V Radial = R	For coding please refer to the pages of ratings	CD VS = BS	0,47 = R47	$\pm 20\%$ = M	SMD:		4x7 = 0407	
			CD VH = VH	1,0 = 010	$\pm 10\%$ = K	Taped = FF	Terminal = T2	5x11,5 = 0511	
PC = Polymer Capacitor	Snap-In = S		CD VZ = VZ	2,2 = 2R2	+30 / -10% = Q	Radial:		6,3x11,5 = 0611	
			CD 261 = LK	100 = 101	+50 / -10% = T	Long Lead = LL	2,0mm = 20	35x80 = 3580	
			CD 261X = QX	1000 = 102		Cut 5,0mm = CB	2,5mm = 25	45x100 = 45100	
			CD 262 = QM	10000 = 103		Cut 4,5mm = CC	3,5mm = 35		
			CD 263 = BK			Cut 4,0mm = CD	5,0mm = 50		
			CD 269 = PH			Cut 3,5mm = CE	7,5mm = 75		
			CD 281 = LL			Cut 3,0mm = CF	10,0mm = 10		
			CD 284 = XY			on request: alternative lead forms (axial, 90° - angle, others)		12,5mm = 12	
			CD 287 = GC						
			CD 28L = QL						
			CD 293 = BZ						
			CD 294 = BW						
			CD 295 = BC						
			CD 296 = KC						
			CD 297 = BB						
			CD 299 = PG						
			CD 29D = HR						
			CD 29H = QH						
			CD 29L = QL						
			HCP = CP						
			HPM = PM						
			HVC = VC						

Snap-In:	
4,0mm Pin Length = T4	2 Pin = P2
6,3mm Pin Length = T6	3 Pin = P3
Soldering Pin = S4	4 Pin = P4
	5 Pin = P5

preferred

Technical Specification SMD Type

Dimensions

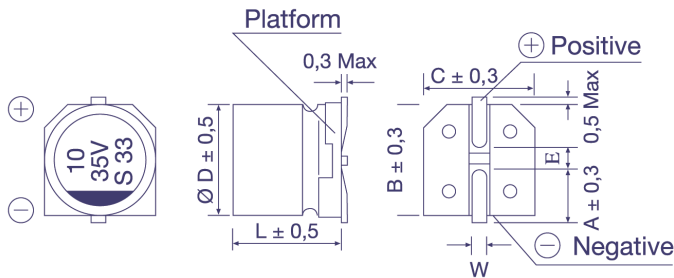

Ø D x L	4x5,4	5x5,4	6,3x5,4	6,3x7,7	8x10,5	8x11,8	10x10,5	10x12,7
A	1,8	2,1	2,4	2,5	2,9	2,9	3,2	3,2
B	4,3	5,3	6,6	6,6	8,3	8,4	10,3	10,4
C	4,3	5,3	6,6	6,6	8,3	8,4	10,3	10,4
E	1,0	1,3	2,2	2,2	3,1	3,1	4,5	4,5
L	5,4	5,4	5,4	7,7	10,5	11,8	10,5	12,7
W	0,5 - 0,8				0,7 - 1,1			

in mm

Taping Dimensions

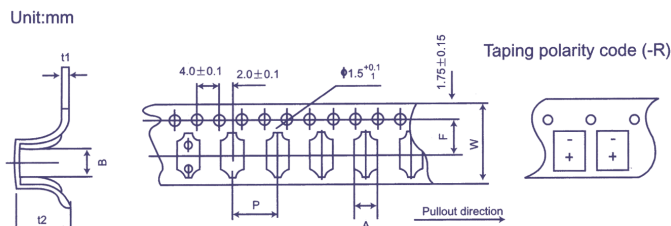

Size (DxL)	w ± 0,3	A ± 0,2	B ± 0,2	P ± 0,1	t2 ± 0,2	F ± 0,1	t1 ± 0,1
4 x 5,4	12,0	5,0	5,0	8,0	5,8	5,5	0,4
5 x 5,4	12,0	6,0	6,0	12,0	5,8	5,5	0,4
6,3 x 5,4	16,0	7,0	7,0	12,0	5,8	7,5	0,4
6,3 x 7,7	16,0	7,0	7,0	12,0	8,4	7,5	0,4
8 x 10,5	24,0	8,7	8,7	16,0	11,0	11,5	0,5
8 x 11,8	24,0	8,7	8,7	16,0	12,3	11,5	0,5
10 x 10,5	24,0	10,7	10,7	16,0	11,0	11,5	0,5
10 x 12,7	24,0	10,7	10,7	16,0	14,0	11,5	0,5

in mm

Soldering Profile (Aluminium Electrolytic Capacitors)

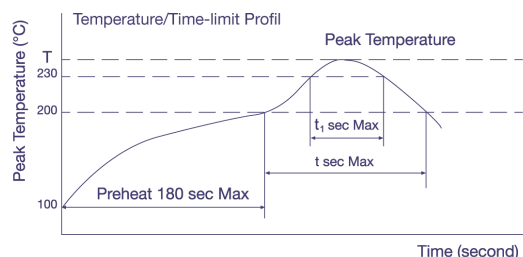

Allowable Range of Peak Temperature

Size	T (°C)	t (second)	t ₁ (second)
Ø 4 ~ 6,3	250	90	40
Ø 8 x 10,5	240	90	30
Ø 10 x 10,5	235	60	30

Diameter	w	D
4; 5	14 ± 1	50 ± 1
6,3	18 ± 1	50 ± 1
8; 10	25 ± 1	50 ± 1
Polymer	25 ± 1	80 ± 1

in mm

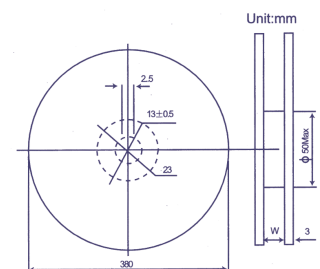

For more details or Soldering Profiles of Radials or Polymer-Capacitors please contact our local Sales Offices.

Technical Specification Snap-In Type

Pin Type: Snap-In
Order Code: T6, T4

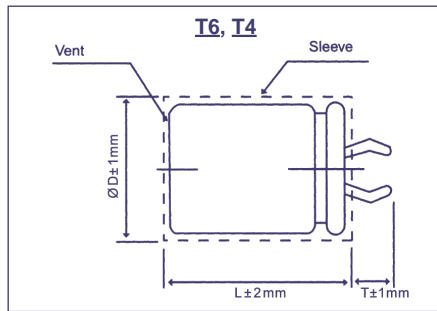

Terminal	T6	T4
Pin Length T	6,3	4,0

Pin Type: Soldering
Order Code: S4

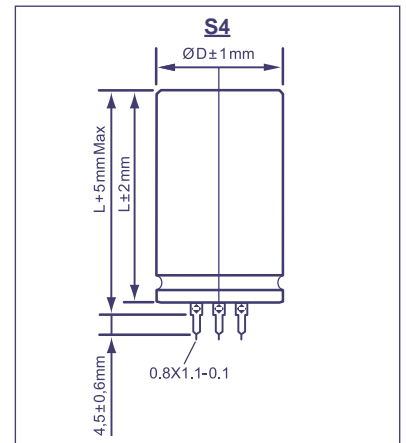

Snap-In Terminal
Order Code: P2, P3, P4

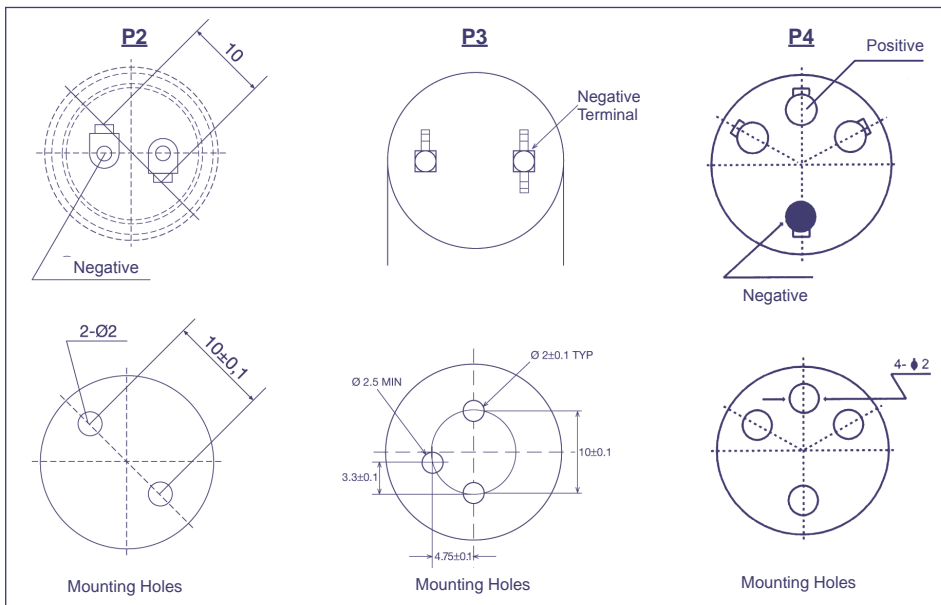

Soldering Terminal
Order Code: P5

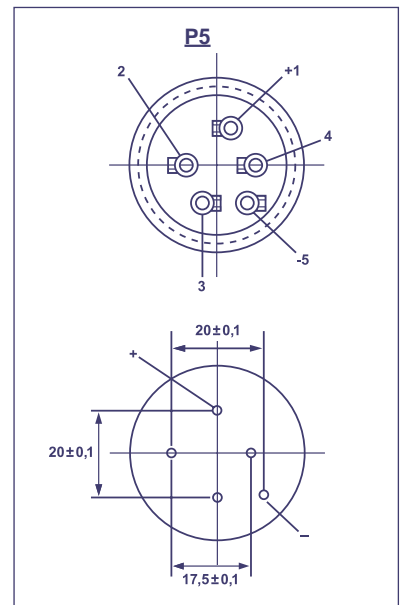

P3 only T4 Terminal

Order Code Screw Type

EC	G	1C	BP	101	M	B	E	160	A361	JExxxxx
Technology	Terminal Type	Rated Voltage Code	Series Code	Capacitance Code	Capacitance Tolerance	Mounting	Diameter	Length	For Terminal Code see tables below	for Specials only
EC = Electrolytic Capacitor	Screw = G	For coding please refer to the pages of ratings	CD 135 = BP	100 = 101	±20% = M	Bolt = B	36 = A	53 = 053		
			CD 136 = PK	1000 = 102	±10% = K	No double sleeve = N	40 = B	65 = 065		
			CD 137 = PX	10000 = 103	+30 / -10% = Q	2 stoppers bracket+double sleeve* = I	51 = C	96 = 096		
			CD 138 = PC		+20 / -0% = R	3 stoppers bracket+double sleeve* = Y	64 = D	100 = 100		
			CD 139 = BL		+50 / -10% = T	No bracket, but double sleeve* = D	77 = E	115 = 115		
				preferred	* Double sleeve for diameter ≥ 51 only		90 = F	236 = 236		
							101 = G			

Technical Specification Screw Type

Dimensions

Standard Housing
Order Code: I, Y, D, N

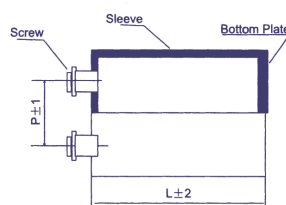
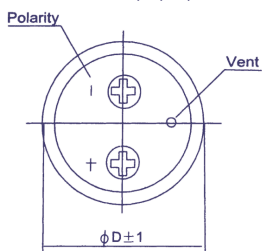

Bolt Housing
Order Code: B

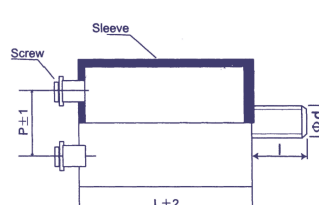

Ø D	Ø d	l
Ø 36	M8	12
≥ Ø 51	M12	16

in mm