

7000h at 85°C

- Small Size
- Long Useful Life
- High Ripple Current
- Industrial Power Supplies and Inverters

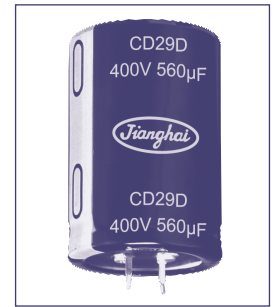
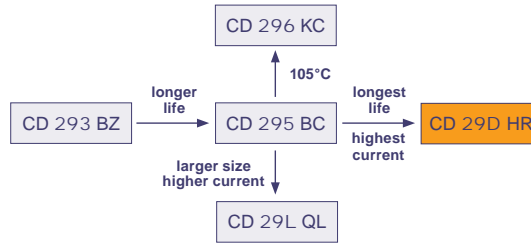

Item	Characteristics						
Operating Temperature Range (°C)	-40 ~ +85						
Voltage Range (V)	160 ~ 450						
Capacitance Range (µF)	47 ~ 2200						
Capacitance Tolerance (20°C, 120Hz)	± 20%						
Leakage Current (µA)	After 5 minutes at 20°C application of rated voltage, leakage current is not more than 0,01CV or 1,5mA, whichever is smaller C: Nominal Capacitance (µF) V: Rated Voltage (V)						
Dissipation Factor (20°C, 120Hz)	Rated Voltage (V)	160	200	250	350	400	450
	Tan δ (max)	0,15				0,12	
Stability at Low Temperature (Impedance Ratio at 120Hz)	Rated Voltage (V)	160 ~ 450					
	Z _{-40°C} / Z _{+20°C}	4					

	Useful Life		Load Life	Endurance Test	Shelf Life
Lifetime	7000h	>100000h	5000h	5000h	1000h
Leakage Current	Not more than specified value		Not more than specified value	Not more than specified value	Not more than specified value
Capacity Change	Within ± 30% of initial value		Within ± 20% of initial value	Within ± 20% of initial value	Within ± 20% of initial value
Dissipation Factor	Not more than 300% of specified value		Not more than 200% of specified value	Not more than 130% of specified value	Not more than 200% of specified value
Condition:					
Applied Voltage	U _R	U _R	U _R	U _R	U _R = 0
Applied Current	I _R	1,2 x I _R	I _R	I _R = 0	I _R = 0
Applied Temperature	85°C	40°C	85°C	85°C	85°C
Failure Rate Level	≤ 1% Failure Rate	≤ 1% Failure Rate	guaranteed		After test: U _R to be applied for 30min >24h before measurement

Multiplier for Ripple Current

Frequency Coefficient

Frequency	50Hz	120Hz	1kHz	10kHz	100kHz
Coefficient	0,87	1,00	1,20	1,35	1,40

Lifetime Diagram

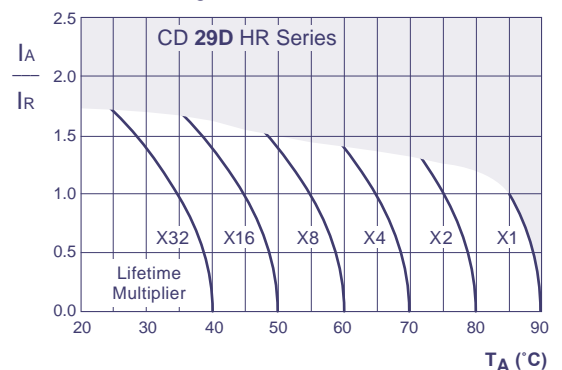

I_A = actual ripple current at 120Hz, I_R = rated ripple current at 120Hz, 85°C
Multiplier of Useful Life as a function of ambient temperature and ripple current load

Ratings for CD 29D HR Series

V _{DC} (Surge Voltage) Code	Rated Capa- cance	Max ESR 20°C, 120Hz	Typ ESR 20°C, 120Hz	Max Ripple Current 85°C, 120Hz	Size Ø D x L
(V)	(µF)	(mΩ)	(mΩ)	(Arms)	(mm)
160 (200) 2C	330	603	355	1,5	22 x 25
	390	511	300	1,6	25 x 25
	470	424	245	1,8	22 x 35
	560	356	215	2,1	22 x 35
		356	215	2,2	25 x 30
	680	356	215	2,1	30 x 25
		293	178	2,6	22 x 40
	820	293	178	2,5	25 x 35
		243	145	2,8	22 x 50
		243	145	2,7	25 x 40
		243	145	2,9	30 x 30
	1000	243	145	2,8	35 x 25
		199	115	3,3	25 x 45
		199	115	3,4	30 x 35
	1200	199	115	3,3	35 x 30
		166	95	3,7	25 x 50
		166	95	3,8	30 x 40
	1500	166	95	3,6	35 x 35
		133	75	4,4	30 x 45
	1800	133	75	4,3	35 x 40
111		70	4,4	35 x 45	
2200	91	58	5,9	35 x 50	
200 (200) 2D	220	905	375	1,2	22 x 25
	330	603	258	1,5	22 x 30
	390	603	258	1,6	25 x 25
		511	221	1,8	22 x 35
	470	511	221	1,8	25 x 30
		424	175	2,0	22 x 40
	560	424	175	2,1	30 x 25
		356	150	2,2	22 x 45
		356	150	2,2	25 x 35
		356	150	2,3	30 x 30
	680	356	150	2,2	35 x 25
		293	128	2,6	25 x 40
	820	293	128	2,4	30 x 30
		243	105	2,7	25 x 50
		243	105	2,8	30 x 40
	1000	243	105	2,6	35 x 30
		199	80	3,4	30 x 40
		199	80	3,6	35 x 35
	1200	166	70	3,8	30 x 50
		166	70	3,7	35 x 40
1500	133	55	4,7	35 x 50	
250 (300) 2E	150	1327	550	0,92	22 x 25
	180	1106	470	0,98	22 x 25
	220	905	370	1,25	22 x 30
		905	370	1,25	25 x 25
	270	737	370	1,25	22 x 35
		603	250	1,64	22 x 40
	330	603	250	1,64	25 x 30
		603	250	1,64	30 x 25
	390	511	220	1,9	22 x 45
		511	220	1,9	25 x 35
	470	424	175	2,2	22 x 50
		424	175	2,2	25 x 40
		424	175	2,2	30 x 30
	560	424	175	2,2	35 x 25
		356	150	2,4	25 x 45
	680	356	150	2,4	30 x 35
		293	123	2,8	30 x 40
	820	293	123	2,8	35 x 30
		243	105	3,2	30 x 45
	1000	243	105	3,2	35 x 35
199		80	3,7	35 x 40	
1200	166	70	4,1	35 x 45	
1500	133	60	4,6	35 x 50	

V _{DC} (Surge Voltage) Code	Rated Capa- cance	Max ESR 20°C, 120Hz	Typ ESR 20°C, 120Hz	Max Ripple Current 85°C, 120Hz	Size Ø D x L
(V)	(µF)	(mΩ)	(mΩ)	(Arms)	(mm)
400 (450) 2G	68	2341	960	0,62	22 x 25
	100	1592	660	0,81	22 x 30
		1592	660	0,83	25 x 25
	120	1327	550	0,93	22 x 35
		1062	440	1,2	22 x 40
	150	1062	440	1,2	25 x 30
		1062	440	1,2	30 x 25
	180	885	360	1,3	22 x 45
		885	360	1,3	25 x 35
		885	360	1,3	30 x 30
		885	360	1,3	35 x 25
	220	724	300	1,5	22 x 50
		724	300	1,5	25 x 40
		724	300	1,5	30 x 35
	270	590	240	1,7	25 x 45
		590	240	1,7	30 x 40
		590	240	1,7	35 x 30
	330	483	200	2,1	30 x 45
		483	200	2,1	35 x 35
	390	409	170	2,3	30 x 50
409		170	2,3	35 x 40	
470	339	140	2,7	35 x 45	
	560	285	110	3,0	35 x 50
450 (500) 2W	47	3387	2800	0,52	22 x 25
	68	2341	1940	0,66	22 x 30
		2341	1940	0,66	25 x 25
	100	1592	1310	0,9	22 x 35
		1592	1310	0,9	25 x 30
	120	1592	1310	0,9	30 x 25
		1327	910	1,1	22 x 40
	150	1327	910	1,1	25 x 35
		1062	880	1,3	22 x 50
		1062	880	1,3	25 x 40
		1062	880	1,3	30 x 30
	180	885	740	1,4	25 x 45
		885	740	1,4	30 x 35
		885	740	1,4	35 x 25
	220	724	590	1,6	25 x 50
		724	590	1,6	30 x 40
		724	590	1,6	35 x 30
	270	590	490	1,9	30 x 45
		590	490	1,9	35 x 35
	330	483	395	2,2	35 x 40
390	409	300	2,4	35 x 45	
470	339	280	2,8	35 x 50	

Snap-In

Custom products are available on request.

Order Code SMD, Radial, Snap-In

EC	R	1C	PT	101	M	FF	25	0611	JE xxxxx
Technology	Terminal Type	Rated Voltage Code	Series Code	Capacitance Code (in μF)	Capacitance Tolerance	Lead Form	Terminal/Pitch Size	Dimension	for Specials only
EC = Electrolytic Capacitor	SMD = V	For coding please refer to the pages of ratings	CD VS = BS	0,47 = R47	$\pm 20\%$ = M	SMD:		4x7 = 0407	
	Radial = R		CD VH = VH	1,0 = 010	$\pm 10\%$ = K	Taped = FF	Terminal = T2	5x11,5 = 0511	
PC = Polymer Capacitor	Snap-In = S		CD VZ = VZ	2,2 = 2R2	+30 / -10% = Q	Radial:		6,3x11,5 = 0611	
			CD 261 = LK	100 = 101	+50 / -10% = T	Long Lead = LL	2,0mm = 20	35x80 = 3580	
			CD 261X = QX	1000 = 102		Cut 5,0mm = CB	2,5mm = 25	45x100 = 45100	
			CD 262 = QM	10000 = 103		Cut 4,5mm = CC	3,5mm = 35		
			CD 263 = BK			Cut 4,0mm = CD	5,0mm = 50		
			CD 269 = PH			Cut 3,5mm = CE	7,5mm = 75		
			CD 281 = LL			Cut 3,0mm = CF	10,0mm = 10		
			CD 284 = XY			on request: alternative lead forms (axial, 90° - angle, others)		12,5mm = 12	
		CD 287 = GC			Snap-In:				
		CD 28L = QL			4,0mm Pin Length = T4	2 Pin = P2			
		CD 293 = BZ			6,3mm Pin Length = T6	3 Pin = P3			
		CD 294 = BW			Soldering Pin = S4	4 Pin = P4			
		CD 295 = BC				5 Pin = P5			
		CD 296 = KC			preferred				
		CD 297 = BB							
		CD 299 = PG							
		CD 29D = HR							
		CD 29H = QH							
		CD 29L = QL							
		HCP = CP							
		HPM = PM							
		HVC = VC							

Technical Specification SMD Type

Dimensions

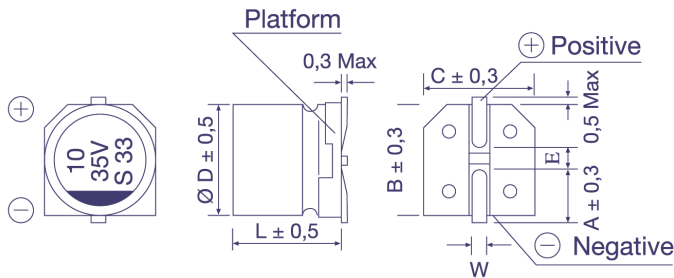

Ø D x L	4x5,4	5x5,4	6,3x5,4	6,3x7,7	8x10,5	8x11,8	10x10,5	10x12,7
A	1,8	2,1	2,4	2,5	2,9	2,9	3,2	3,2
B	4,3	5,3	6,6	6,6	8,3	8,4	10,3	10,4
C	4,3	5,3	6,6	6,6	8,3	8,4	10,3	10,4
E	1,0	1,3	2,2	2,2	3,1	3,1	4,5	4,5
L	5,4	5,4	5,4	7,7	10,5	11,8	10,5	12,7
W	0,5 - 0,8				0,7 - 1,1			

in mm

Taping Dimensions

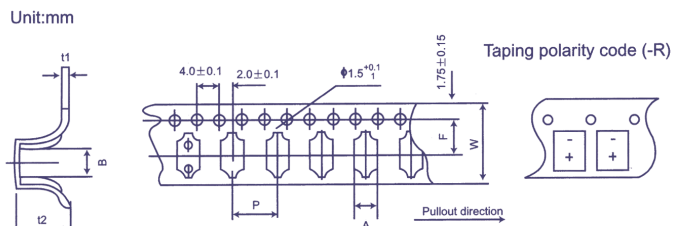

Size (DxL)	w ± 0,3	A ± 0,2	B ± 0,2	P ± 0,1	t2 ± 0,2	F ± 0,1	t1 ± 0,1
4 x 5,4	12,0	5,0	5,0	8,0	5,8	5,5	0,4
5 x 5,4	12,0	6,0	6,0	12,0	5,8	5,5	0,4
6,3 x 5,4	16,0	7,0	7,0	12,0	5,8	7,5	0,4
6,3 x 7,7	16,0	7,0	7,0	12,0	8,4	7,5	0,4
8 x 10,5	24,0	8,7	8,7	16,0	11,0	11,5	0,5
8 x 11,8	24,0	8,7	8,7	16,0	12,3	11,5	0,5
10 x 10,5	24,0	10,7	10,7	16,0	11,0	11,5	0,5
10 x 12,7	24,0	10,7	10,7	16,0	14,0	11,5	0,5

in mm

Soldering Profile (Aluminium Electrolytic Capacitors)

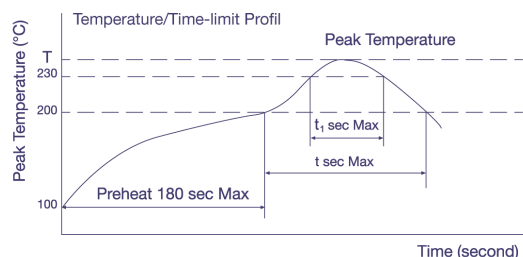

Allowable Range of Peak Temperature

Size	T (°C)	t (second)	t ₁ (second)
Ø 4 ~ 6,3	250	90	40
Ø 8 x 10,5	240	90	30
Ø 10 x 10,5	235	60	30

Diameter	w	D
4; 5	14 ± 1	50 ± 1
6,3	18 ± 1	50 ± 1
8; 10	25 ± 1	50 ± 1
Polymer	25 ± 1	80 ± 1

in mm

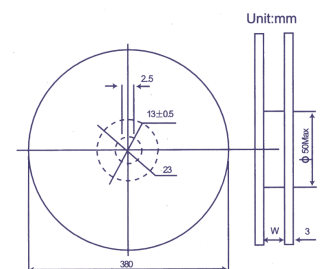

For more details or Soldering Profiles of Radials or Polymer-Capacitors please contact our local Sales Offices.

Technical Specification Snap-In Type

Pin Type: Snap-In
Order Code: T6, T4

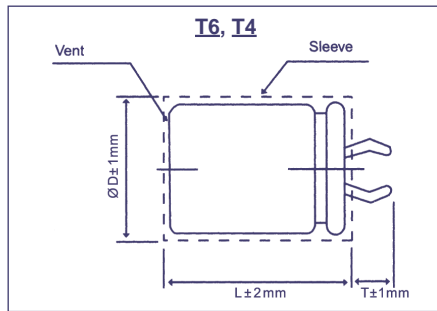

Terminal	T6	T4
Pin Length T	6,3	4,0

Pin Type: Soldering
Order Code: S4

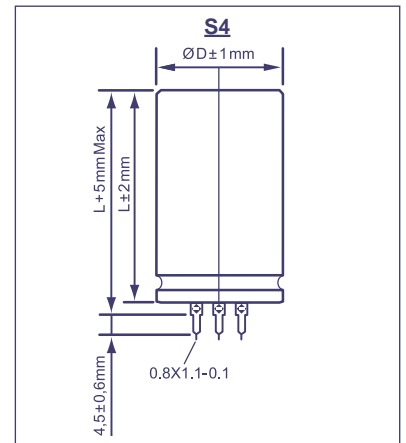

Snap-In Terminal
Order Code: P2, P3, P4

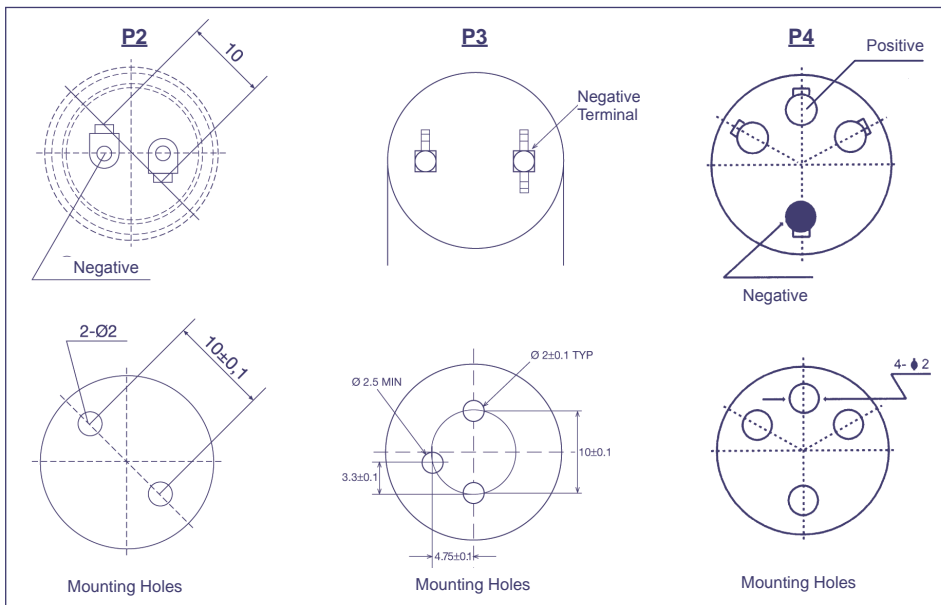

Soldering Terminal
Order Code: P5

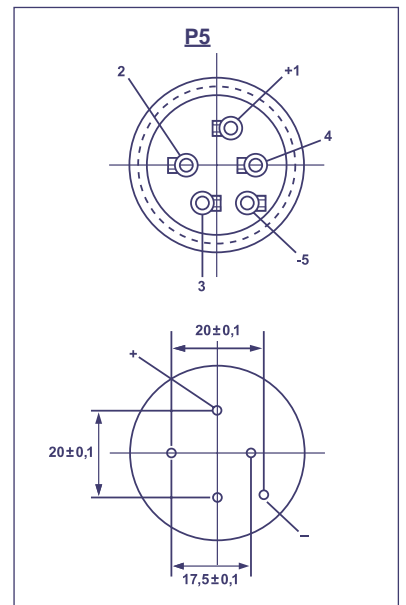

P3 only T4 Terminal

Order Code Screw Type

EC	G	1C	BP	101	M	B	E	160	A361	JExxxxx
Technology	Terminal Type	Rated Voltage Code	Series Code	Capacitance Code	Capacitance Tolerance	Mounting	Diameter	Length	For Terminal Code see tables below	for Specials only
EC = Electrolytic Capacitor	Screw = G	For coding please refer to the pages of ratings	CD 135 = BP	100 = 101	±20% = M	Bolt = B	36 = A	53 = 053		
			CD 136 = PK	1000 = 102	±10% = K	No double sleeve = N	40 = B	65 = 065		
			CD 137 = PX	10000 = 103	+30 / -10% = Q	2 stoppers bracket+double sleeve* = I	51 = C	96 = 096		
			CD 138 = PC		+20 / -0% = R	3 stoppers bracket+double sleeve* = Y	64 = D	100 = 100		
			CD 139 = BL		+50 / -10% = T	No bracket, but double sleeve* = D	77 = E	115 = 115		
				preferred	* Double sleeve for diameter ≥ 51 only		90 = F	236 = 236		
							101 = G			

Technical Specification Screw Type

Dimensions

Standard Housing
Order Code: I, Y, D, N

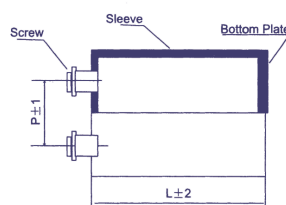
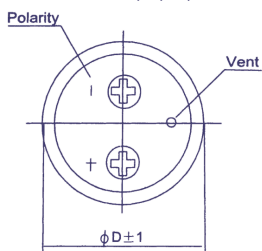

Bolt Housing
Order Code: B

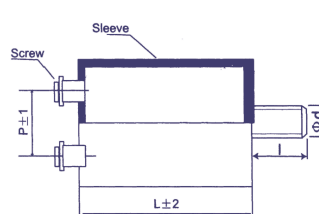

Ø D	Ø d	l
Ø 36	M8	12
≥ Ø 51	M12	16

in mm