

T-45-23-29

CD4026A, CD4033A Types

CMOS Decade Counters/Dividers

With Decoded 7-Segment Display Outputs and:
 Display Enable - CD4026A
 Ripple Blanking - CD4033A

The RCA-CD4026A and CD4033A each consist of a 5-stage Johnson decade counter and an output decoder which converts the Johnson code to a 7-segment decoded output for driving each stage in a numerical display.

These devices are particularly advantageous in display applications where low power dissipation and/or low package count are important.

Inputs common to both types are CLOCK, RESET, & CLOCK INHIBIT; common outputs are CARRY OUT and the seven decoded outputs (a, b, c, d, e, f, g). Additional inputs and outputs for the CD4026A include DISPLAY ENABLE IN and UNGATED "C-SEGMENT" outputs. Signals peculiar to the CD4033A are RIPPLE-BLANKING INPUT and LAMP TEST INPUT and a RIPPLE-BLANKING OUTPUT.

A high RESET signal clears the decade counter to its zero count. The counter is advanced one count at the positive clock signal transition if the CLOCK INHIBIT signal is low. Counter advancement via the clock line is inhibited when the CLOCK INHIBIT signal is high. The CLOCK INHIBIT signal can be used as a negative-edge clock if the clock line is held high. Antilock gating is provided on the Johnson counter, thus assuring proper counting sequence. The CARRY-OUT (C_{OUT}) signal completes one cycle every ten CLOCK INPUT cycles and is used to clock the succeeding decade directly in a multi-decade counting chain.

The seven decoded outputs (a, b, c, d, e, f, g) illuminate the proper segments in a seven segment display device used for representing the decimal numbers 0 to 9. The 7-segment outputs go high on selection in the CD4033A; in the CD4026A these outputs go high only when the DISPLAY ENABLE IN is high.

CD4026A

When the DISPLAY ENABLE IN is low the seven decoded outputs are forced low regardless of the state of the counter. Activation of the display only when required results in significant power savings. This system also facilitates implementation of display-character multiplexing.

The CARRY OUT and UNGATED "C-SEGMENT" signals are not gated by the DISPLAY ENABLE and therefore are available continuously. This feature is a requirement in implementation of certain divider functions such as divide-by-60 and divide-by-12.

CD4033A

The CD4033A has provisions for automatic blanking of the non-significant zeros in a

multi-digit decimal number which results in an easily readable display consistent with normal writing practice. For example, the number 0050.07000 in an eight digit display would be displayed as 50.07. Zero suppression on the Integer side is obtained by connecting the RBI terminal of the CD4033A associated with the most significant digit in the display to a low-level voltage and connecting the RBO terminal of that stage to the RBI terminal of the CD4033A in the next-lower significant position in the display. This procedure is continued for each succeeding CD4033A on the integer side of the display.

On the fraction side of the display the RBI of the CD4033A associated with the least significant bit is connected to a low level voltage and the RBO of that CD4033A is connected to the RBI terminal of the CD4033A in the next more-significant-bit position. Again, this procedure is continued for all CD4033A's on the fraction side of the display.

In a purely fractional number the zero immediately preceding the decimal point can be displayed by connecting the RBI of that stage to a high level voltage (instead of to the RBO of the next more-significant-stage). For Example: optional zero → 0.7346.

Likewise, the zero in a number such as 763.0 can be displayed by connecting the RBI of the CD4033A associated with it to a high-level voltage.

Ripple blanking of non-significant zeros provides an appreciable savings in display power.

The CD4033A has a LAMP TEST input which, when connected to a high-level voltage, overrides normal decoder operation and enables a check to be made on possible display malfunctions by putting the seven outputs in the high state.

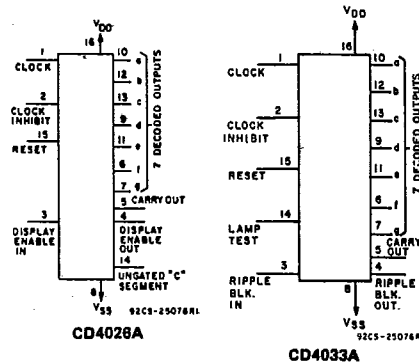

FUNCTIONAL DIAGRAMS

Features:

- Counter and 7-segment decoding in one package
- Easily interfaced with 7-segment display types
- Fully static counter operation: DC to 2.5 MHz (typ.)
- Ideal for low-power displays
- Display Enable Output (CD4026A)
- "Ripple Blanking" and Lamp Test (CD4033A)
- Quiescent current specified to 15 V
- Maximum input leakage current of 1 μA at 15 V (full package-temperature range)
- 1-V noise margin (full package-temperature range)

Applications:

- Decade counting/7-segment decimal display
- Frequency division/7-segment decimal displays
- Clock/watches/timers (e.g. ÷ 60, ÷ 60, ÷ 12 counter/display)
- Counter/display driver for meter applications

These types are supplied in 16-lead hermetic dual-in-line ceramic packages (D and F suffixes), 16-lead dual-in-line plastic package (E suffix), 16-lead ceramic flat packages (K suffix), and in chip form (H suffix).

MAXIMUM RATINGS, Absolute-Maximum Values:

STORAGE-TEMPERATURE RANGE (T _{stg})	-65 to +150°C
OPERATING-TEMPERATURE RANGE (T _A):		
PACKAGE TYPES D, F, K, H	-55 to +125°C
PACKAGE TYPE E	-40 to +85°C
DC SUPPLY-VOLTAGE RANGE, (V _{DD})		
(Voltages referenced to V _{SS} Terminal):	-0.5 to +15 V
POWER DISSIPATION PER PACKAGE (P _D)		
FOR T _A = -40 to +60°C (PACKAGE TYPE E)	500 mW
FOR T _A = +60 to +85°C (PACKAGE TYPE E)	Derate Linearly at 12 mW/°C to 200 mW
FOR T _A = -55 to +100°C (PACKAGE TYPES D, F, K)	500 mW
FOR T _A = +100 to +125°C (PACKAGE TYPES D, F, K)	Derate Linearly at 12 mW/°C to 200 mW
DEVICE DISSIPATION PER OUTPUT TRANSISTOR		
FOR T _A = FULL PACKAGE-TEMPERATURE RANGE (ALL PACKAGE TYPES)	100 mW
INPUT VOLTAGE RANGE, ALL INPUTS	-0.5 to V _{DD} + 0.5 V
LEAD TEMPERATURE (DURING SOLDERING):		
At distance 1/16 ± 1/32 inch (1.59 ± 0.79 mm) from case for 10 s max.	+265°C

CD4026A, CD4033A Types

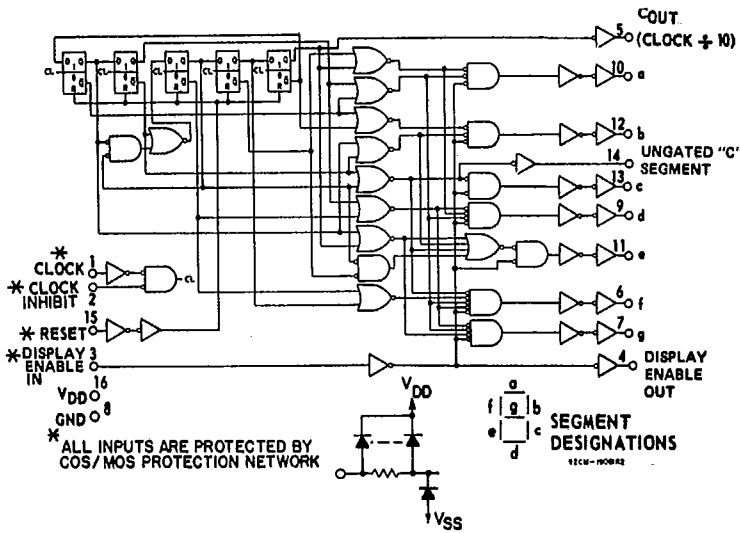

Fig. 1 - CD4026A logic diagram.

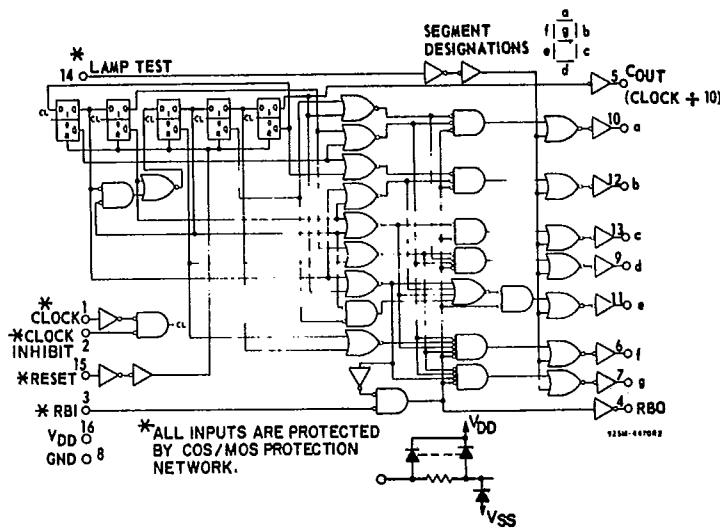

Fig. 3 - CD4033A logic diagram.

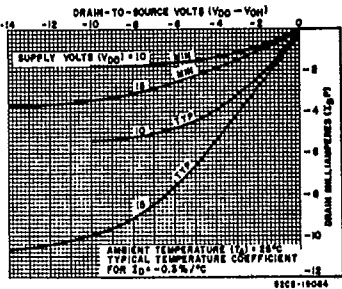

Fig. 6 - Minimum and typical output p-channel decoded drain characteristics @ V_{DD}=10 & 15 V.

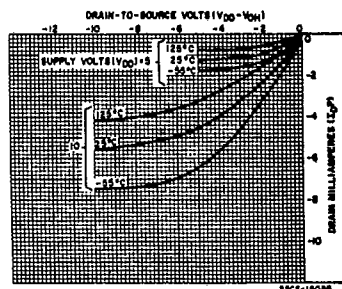

Fig. 7 - Typical output p-channel decoded drain characteristics as a function of temperature.

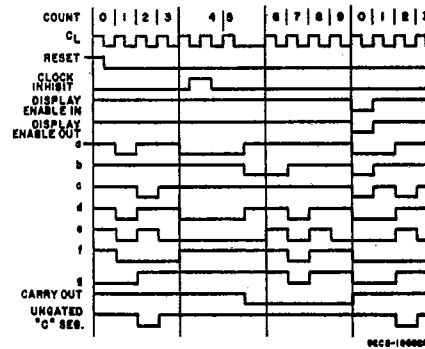

Fig. 2 - CD4026A timing diagram.

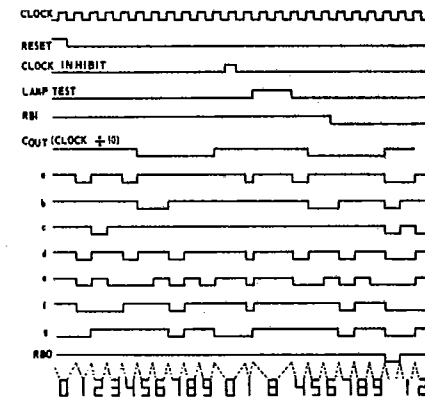

Fig. 4 - CD4033A timing diagram.

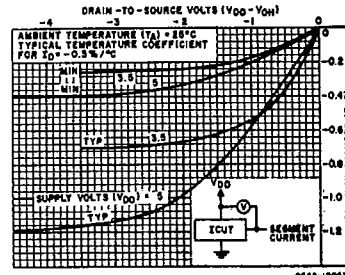

Fig. 5 - Minimum and typical output p-channel decoded drain characteristics @ V_{DD}=3.5 & 5 V.

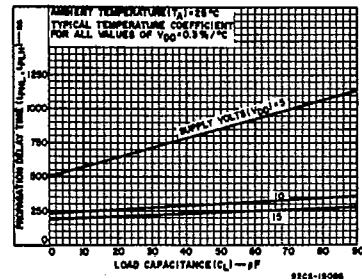

Fig. 8 - Typical propagation delay time vs. C_L for decoded outputs.

CD4026A, CD4033A Types

RECOMMENDED OPERATING CONDITIONS at $T_A = 25^\circ\text{C}$, Except as Noted.
For maximum reliability, nominal operating conditions should be selected so that operation is always within the following ranges:

CHARACTERISTIC	VDD (V)	LIMITS				UNITS
		D, F, K, H Packages		E Package		
		Min.	Max.	Min.	Max.	
Supply-Voltage Range (For $T_A =$ Full Package-Temperature Range)		3	12	3	12	V
Clock Inhibit Setup Time, t_s	5 10	500 200	— —	700 300	— —	ns
Clock Pulse Width, t_W	5 10	330 170	— —	500 250	— —	ns
Clock Input Frequency, f_{CL}	5 10	dc dc	1.5 3	dc dc	1 2	MHz
Clock Rise or Fall Time, t_{rCL} , t_{fCL}	5 10	— —	15 15	— —	15 15	μs
Reset Pulse Width, t_W	5 10	330 165	— —	550 250	— —	ns
Reset Removal Time	5 10	750 225	— —	1000 275	— —	ns

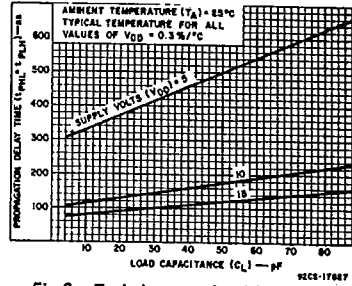

Fig. 9 - Typical propagation delay time vs. C_L for carry outputs.

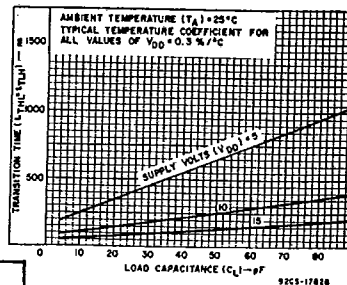

Fig. 10 - Typical transition time vs. C_L for decoded outputs.

STATIC ELECTRICAL CHARACTERISTICS

Characteristic	Conditions			Limits at Indicated Temperatures ($^\circ\text{C}$)								Units	
				D, F, K, H Packages				E Package					
	V _O (V)	V _{IN} (V)	V _{DD} (V)	-55	+25		+125	-40	+25		+85		
Quiescent Device Current I_Q Max.	—	—	5	5	0.3	5	300	60	0.5	50	700	μA	
	—	—	10	10	0.5	10	600	100	1	100	1400		
	—	—	15	50	1	50	2000	500	5	500	5000		
Output Voltage: Low-Level, V_{OL}	—	5	5	0 Typ.; 0.05 Max.								V	
	—	10	10	0 Typ.; 0.05 Max.									
High Level, V_{OH}	—	0	5	4.95 Min.; 5 Typ.								V	
	—	0	10	9.95 Min.; 10 Typ.									
Noise Immunity: Inputs Low, V_{NL}	—	—	5	1.5 Min.; 2.25 Typ.								V	
	—	—	10	3 Min.; 4.5 Typ.									
Inputs High, V_{NH}	—	—	5	1.5 Min.; 2.25 Typ.								V	
	—	—	10	3 Min.; 4.5 Typ.									
Noise Margin: Inputs Low, V_{NML}	4.5	—	5	1 Min.								V	
	9	—	10	1 Min.									
Inputs High, V_{NMH}	0.5	—	5	1 Min.								V	
	1	—	10	1 Min.									
Output Drive Current n-Channel (Sink), I_{DN} Min.	Decoded Outputs	0.5	—	5	0.15	0.24	0.12	0.09	0.08	0.24	0.06	0.05	mA
		0.5	—	10	0.32	0.5	0.25	0.18	0.15	0.5	0.12	0.1	
	Carry Output	0.5	—	5	0.12	0.4	0.15	0.1	0.095	0.4	0.08	0.06	
		0.5	—	10	0.45	1	0.35	0.25	0.3	1	0.25	0.2	
p-Channel (Source), I_{DP} Min.	Decoded Outputs	4.5	—	5	-0.21	-0.28	-0.14	-0.1	-0.09	-0.28	-0.07	-0.06	mA
		9.5	—	10	-0.45	-0.6	-0.3	-0.22	-0.2	-0.6	-0.15	-0.13	
	Carry Output	4.5	—	5	-0.12	-0.4	-0.15	-0.1	-0.095	-0.4	-0.08	-0.06	
		9.5	—	10	-0.45	-1	-0.35	-0.25	-0.3	-1	-0.24	-0.2	
Input Leakage Current, I_{IL} , I_{IH}	Any Input			$\pm 10^{-5}$ Typ., ± 1 Max.								μA	

CD4026A, CD4033A Types

DYNAMIC ELECTRICAL CHARACTERISTICS at $T_A = 25^\circ\text{C}$, Input $t_r, t_f = 20\text{ ns}$, $C_L = 15\text{ pF}$, $R_L = 200\text{ k}\Omega$

CHARACTERISTIC	TEST CONDITIONS	LIMITS						UNITS
		D, F, K, H Packages			E Package			
		VDD (V)	Min.	Typ.	Max.	Min.	Typ.	
CLOCKED OPERATION								
Propagation Delay Time; t_{PLH}, t_{PHL} Carry Out Line	5	-	350	1000	-	350	1300	ns
	10	-	125	250	-	125	300	
Decode Out Lines	5	-	600	1700	-	600	2200	ns
	10	-	250	600	-	250	700	
Transition Time; t_{THL}, t_{TLH} Carry Out Line	5	-	100	300	-	100	350	ns
	10	-	50	150	-	50	200	
Decode Out Lines	5	-	300	900	-	300	1200	ns
	10	-	125	350	-	125	450	
Maximum Clock Input Frequency, f_{CL}^{Δ}	5	1.5	2.5	-	1	2.5	-	MHz
	10	3	5	-	2	5	-	
Min. Clock Pulse Width, t_W	5	-	200	330	-	200	500	ns
	10	-	100	170	-	100	250	
Clock Rise & Fall Time; t_r, t_f	5	-	-	15	-	-	15	μs
	10	-	-	15	-	-	15	
Min. Clock Inhibit Set Up Time, t_s	5	-	175	500	-	175	700	ns
	10	-	75	200	-	75	300	
Average Input Capacitance, C_i	Any Input	-	5	-	-	5	-	pF
RESET OPERATION								
Propagation Delay Time: t_{PLH}, t_{PHL} To Carry Out Line	5	-	350	1000	-	350	1300	ns
	10	-	125	250	-	125	300	
To Decode Out Lines	5	-	550	1400	-	550	1900	ns
	10	-	240	600	-	240	600	
Min. Reset Pulse Width t_W	5	-	200	330	-	200	500	ns
	10	-	100	165	-	100	250	
Min. Reset Removal Time	5	-	300	750	-	300	1000	ns
	10	-	100	225	-	100	275	

Δ Measured with respect to carry out line.

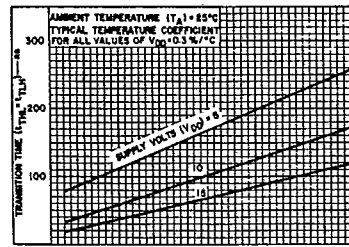

Fig. 11 - Typical transition time vs. C_L for carry output.

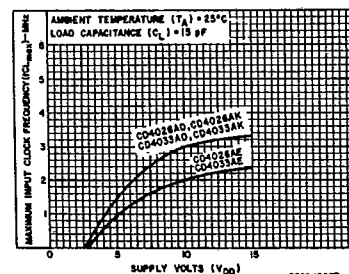

Fig. 12 - Maximum input clock frequency vs. V_{DD} .

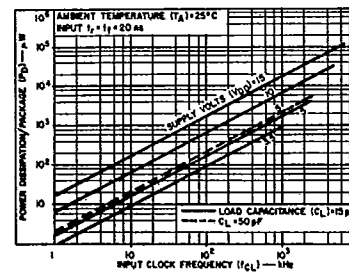

Fig. 13 - Typical dissipation characteristics.

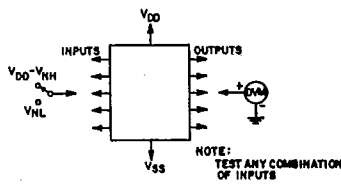

Fig. 14 - Noise immunity test circuit.

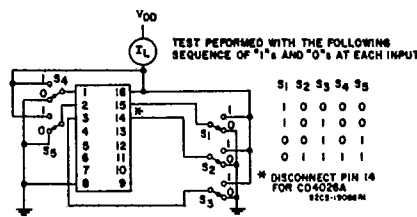

Fig. 15 - Quiescent device current test circuit.

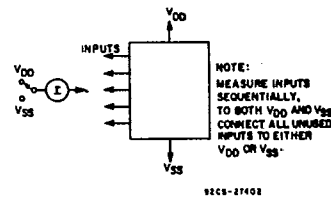
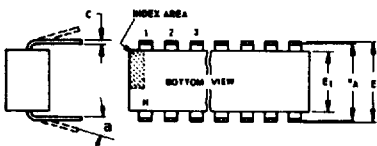
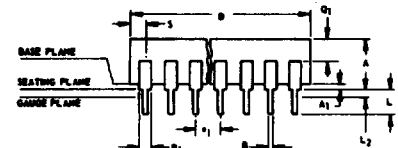

Fig. 16 - Input leakage current test circuit.

Dimensional Outlines

Dual-In-Line Welded-Seal Ceramic Packages



- NOTES:**
Refer to Rules for Dimensioning (JEDEC Publication No. 95) for Axial Lead Product Outlines.
- When this device is supplied solder-dipped, the maximum lead thickness (narrow portion) will not exceed 0.013" (0.33 mm).
 - Leads within 0.005" (0.12 mm) radius of True Position (TP) at gauge plane with maximum material condition and unit installed.
 - e_A applies in zone L₂ when unit installed.
 - a applies to spread leads prior to installation.
 - N is the maximum quantity of lead positions.
 - N₁ is the quantity of allowable missing leads.

(D) SUFFIX (JEDEC MO-001-AD)
14-Lead Dual-In-Line Welded-Seal Ceramic Package

SYMBOL	INCHES		NOTE	MILLIMETERS	
	MIN.	MAX.		MIN.	MAX.
A	0.120	0.160		3.05	4.06
A ₁	0.020	0.065		0.51	1.65
B	0.014	0.020		0.356	0.508
B ₁	0.060	0.065		1.27	1.65
C	0.008	0.012	1	0.204	0.304
D	0.745	0.770		18.93	19.55
E	0.300	0.325		7.62	8.25
E ₁	0.240	0.260		6.10	6.60
e ₁	0.100 TP		2	2.54 TP	
e _A	0.300 TP		2, 3	7.62 TP	
L	0.125	0.150		3.18	3.81
L ₂	0.000	0.030		0.000	0.76
a	0°	15°	4	0°	15°
N	14		5	14	
N ₁	0		6	0	
Q ₁	0.050	0.085		1.27	2.15
S	0.065	0.090		1.66	2.28

92SS-4411R2

(D) SUFFIX (JEDEC MO-001-AE)
16-Lead Dual-In-Line Welded-Seal Ceramic Package

SYMBOL	INCHES		NOTE	MILLIMETERS	
	MIN.	MAX.		MIN.	MAX.
A	0.120	0.160		3.05	4.06
A ₁	0.020	0.065		0.51	1.65
B	0.014	0.020		0.356	0.508
B ₁	0.035	0.065		0.89	1.65
C	0.008	0.012	1	0.204	0.304
D	0.745	0.785		18.93	19.93
E	0.300	0.325		7.62	8.25
E ₁	0.240	0.260		6.10	6.60
e ₁	0.100 TP		2	2.54 TP	
e _A	0.300 TP		2, 3	7.62 TP	
L	0.125	0.150		3.18	3.81
L ₂	0.000	0.030		0.000	0.76
a	0°	15°	4	0°	15°
N	16		5	16	
N ₁	0		6	0	
Q ₁	0.050	0.085		1.27	2.15
S	0.015	0.060		0.39	1.52

92SS-4266R5

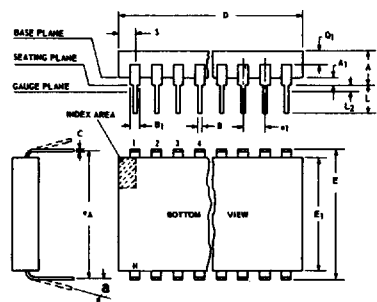

- NOTES:**
Refer to Rules for Dimensioning (JEDEC Publication No. 95) for Axial Lead Product Outlines.
- When this device is supplied solder-dipped, the maximum lead thickness (narrow portion) will not exceed 0.013" (0.33 mm).
 - Leads within 0.005" (0.12 mm) radius of True Position (TP) at gauge plane with maximum material condition and unit installed.
 - e_A applies in zone L₂ when unit installed.
 - a applies to spread leads prior to installation.
 - N is the maximum quantity of lead positions.
 - N₁ is the quantity of allowable missing leads.

(D) SUFFIX (JEDEC MO-015-AG)
24-Lead Dual-In-Line Welded-Seal Ceramic Package

SYMBOL	INCHES		NOTE	MILLIMETERS	
	MIN.	MAX.		MIN.	MAX.
A	0.090	0.200		2.29	5.08
A ₁	0.020	0.070		0.51	1.78
B	0.015	0.020		0.381	0.508
B ₁	0.045	0.055		1.143	1.397
C	0.008	0.012	1	0.204	0.304
D	1.15	1.22		29.21	30.98
E	0.600	0.625		15.24	15.87
E ₁	0.480	0.520		12.20	13.20
e ₁	0.100 TP		2	2.54 TP	
e _A	0.600 TP		2, 3	15.24 TP	
L	0.100	0.180		2.54	4.57
L ₂	0.000	0.030		0.00	0.76
a	0°	15°	4	0°	15°
N	24		5	24	
N ₁	0		6	0	
Q ₁	0.020	0.080		0.51	2.03
S	0.020	0.060		0.51	1.52

92CS-19948R4

(D) SUFFIX (JEDEC MO-015-AH)
28-Lead Dual-In-Line Welded-Seal Ceramic Package

SYMBOL	INCHES		NOTE	MILLIMETERS	
	MIN.	MAX.		MIN.	MAX.
A	0.090	0.200		2.29	5
A ₁	0	0.070	2	0	1.77
B	0.015	0.020		0.381	0.508
B ₁	0.015	0.065		0.39	1.39
C	0.008	0.012	1	0.204	0.304
D	1.380	1.420		35.06	36.06
E	0.600	0.625		15.24	15.87
E ₁	0.485	0.515		12.32	13.08
e ₁	0.100 TP		2	2.54 TP	
e _A	0.600 TP		2, 3	15.24 TP	
L	0.100	0.200		2.6	5
L ₂	0	0.030		0	0.76
a	0°	15°	4	0°	15°
N	28		5	28	
N ₁	0		6	0	
Q ₁	0.020	0.070		0.51	1.77
S	0.040	0.070		1.02	1.77

92CM-20250R2

TO-5 Style Package

(T) SUFFIX (JEDEC MO-006-AG)
12-Lead Metal Package

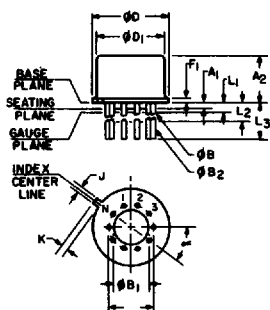

92CS-19774

SYMBOL	INCHES		NOTE	MILLIMETERS	
	MIN.	MAX.		MIN.	MAX.
a	0.230		2	5.84 TP	
A ₁	0	0		0	0
A ₂	0.165	0.185		4.19	4.70
φB	0.016	0.019	3	0.407	0.482
φB ₁	0	0		0	0
φB ₂	0.016	0.021	3	0.407	0.533
φD	0.335	0.370		8.51	9.39
φD ₁	0.305	0.335		7.75	8.50
F ₁	0.020	0.040		0.51	1.01
j	0.028	0.034		0.712	0.863
k	0.029	0.045	4	0.74	1.14
L ₁	0.000	0.050	3	0.00	1.27
L ₂	0.250	0.500	3	6.4	12.7
L ₃	0.500	0.562	3	12.7	14.27
a	30° TP			30° TP	
N	12		6	12	
N ₁	1		5	1	

NOTES:

- Refer to Rules for Dimensioning Axial Lead Product Outlines.
- Leads at gauge plane within 0.007" (0.178 mm) radius of True Position (TP) at maximum material condition.
- φB applies between L₁ and L₂. φB₂ applies between L₂ and 0.500" (12.70 mm) from seating plane. Diameter is uncontrolled in L₁ and beyond 0.500" (12.70 mm).
- Measure from Max. φD.
- N₁ is the quantity of allowable missing leads.
- N is the maximum quantity of lead positions.

Dimensional Outlines (Cont'd)

DUAL-IN-LINE SIDE-BRAZED CERAMIC PACKAGES

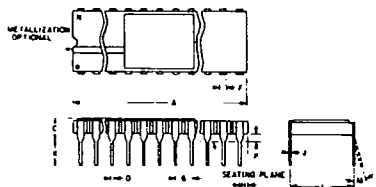

(D) SUFFIX
18-Lead Dual-in-Line
Side-Brazed Ceramic Package

SYMBOL	INCHES		NOTE	MILLIMETERS	
	MIN.	MAX.		MIN.	MAX.
A	0.890	0.915		22.606	23.241
C	—	0.200		—	5.080
D	0.015	0.021		0.381	0.533
F	0.054	REF.	1	1.371	REF.
G	0.100	BSC	1	2.54	BSC
H	0.035	0.065		0.889	1.651
J	0.008	0.012	3	0.203	0.304
K	0.125	0.150		3.175	3.810
L	0.290	0.310	2	7.366	7.874
M	0°	15°		0°	15°
P	0.025	0.045		0.635	1.143
N	18			18	

92CS-27231R1

(D) SUFFIX
22-Lead Dual-in-Line
Side-Brazed Ceramic Package

SYMBOL	INCHES		NOTE	MILLIMETERS	
	MIN.	MAX.		MIN.	MAX.
A	1.065	1.100		27.05	27.94
C	0.085	0.145		2.16	3.68
D	0.017	0.023		0.43	0.58
F	0.040	REF.	1	1.02	REF.
G	0.100	BSC	1	2.54	BSC
H	0.030	0.070		0.76	1.78
J	0.008	0.012	3	0.20	0.30
K	0.125	0.175		3.18	4.45
L	0.380	0.420	2	9.65	10.67
M	—	7°		—	7°
P	0.025	0.050		0.64	1.27
N	22			22	

92CS-25186R2

NOTES:

- Leads within 0.005" (0.13 mm) radius of True Position at maximum material condition.
- Dimension "L" to center of leads when formed parallel.
- When this device is supplied solder-dipped, the maximum lead thickness (narrow portion) will not exceed 0.013" (0.33 mm).

(D) SUFFIX
24-Lead Dual-in-Line
Side-Brazed Ceramic Package

SYMBOL	INCHES		NOTE	MILLIMETERS	
	MIN.	MAX.		MIN.	MAX.
A	1.180	1.220		29.98	30.98
C	0.085	0.145		2.16	3.68
D	0.015	0.023		0.39	0.58
F	0.040	REF.		1.02	REF.
G	0.100	BSC	1	2.54	BSC
H	0.030	0.070		0.77	1.77
J	0.008	0.012	3	0.21	0.30
K	0.125	0.175		3.18	4.44
L	0.580	0.620	2	14.74	15.74
M	—	7°		—	7°
P	0.025	0.050		0.64	1.27
N	24			24	

92CS-30968R1

(D) SUFFIX
40-Lead Dual-in-Line
Side-Brazed Ceramic Package

SYMBOL	INCHES		NOTE	MILLIMETERS	
	MIN.	MAX.		MIN.	MAX.
A	1.980	2.020		50.30	51.30
C	0.095	0.155		2.43	3.93
D	0.017	0.023		0.43	0.58
F	0.050	REF.		1.27	REF.
G	0.100	BSC	1	2.54	BSC
H	0.030	0.070		0.76	1.78
J	0.008	0.012	3	0.20	0.30
K	0.125	0.175		3.18	4.45
L	0.580	0.620	2	14.74	15.74
M	—	7°		—	7°
P	0.025	0.050		0.64	1.27
N	40			40	

92CM-27029R2

Dual-In-Line Plastic and Frit-Seal Ceramic Packages

(E) SUFFIX (JEDEC MO-001-AN)
8-Lead Dual-In-Line Plastic
(Mini-DIP) Package

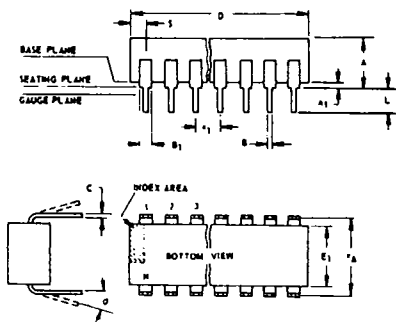

SYMBOL	INCHES		NOTE	MILLIMETERS	
	MIN.	MAX.		MIN.	MAX.
A	0.155	0.200		3.94	5.08
A ₁	0.020	0.050		0.508	1.27
B	0.014	0.020		0.356	0.508
B ₁	0.035	0.065		0.889	1.65
C	0.008	0.012	1	0.203	0.304
D	0.370	0.400		9.40	10.16
E	0.300	0.325		7.62	8.25
E ₁	0.240	0.260		6.10	6.60
e ₁	0.100	TP	2	2.54	TP
e _A	0.300	TP	2, 3	7.62	TP
L	0.125	0.150		3.18	3.81
L ₂	0.000	0.030		0.000	0.762
a	0	15	4	0	15
N	8		5	8	
N ₁	0		6	0	
O ₁	0.040	0.075		1.02	1.90
S	0.015	0.060		0.381	1.52

92CS-24026R1

NOTES:

- Refer to Rules for Dimensioning (JEDEC Publication No. 95) for Axial Lead Product Outlines.
- When this device is supplied solder-dipped, the maximum lead thickness (narrow portion) will not exceed 0.013".
 - Leads within 0.005" (0.12 mm) radius of True Position (TP) at gauge plane with maximum material condition and unit installed.
 - e_A applies in zone L₂ when unit installed.
 - a applies to spread leads prior to installation.
 - N is the maximum quantity of lead positions.
 - N₁ is the quantity of allowable missing leads.

Dimensional Outlines (Cont'd)

Dual-In-Line Plastic and Frit-Seal Ceramic Packages (Cont'd)

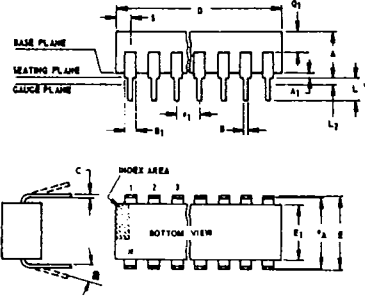

- NOTES: Refer to Rules for Dimensioning (JEDEC Publication No. 95) for Axial Lead Product Outlines. 1. When this device is supplied solder dipped, the maximum lead thickness (narrow portion) will not exceed 0.013" (0.33 mm). 2. Leads within 0.005" (0.12 mm) radius of True Position (TP) at gauge plane with maximum material condition and unit installed. 3. eA applies in zone L2 when unit installed. 4. a applies to spread leads prior to installation. 5. N is the maximum quantity of lead positions. 6. N1 is the quantity of allowable missing leads.

(E) and (F) SUFFIXES (JEDEC MO-001-AB) 14-Lead Dual-In-Line Plastic or Frit-Seal Ceramic Package

Table with columns: SYMBOL, INCHES (MIN, MAX), NOTE, MILLIMETERS (MIN, MAX). Rows include dimensions A, A1, B, B1, C, D, E, E1, e1, eA, L, L2, a, N, N1, Q1, S.

92SC-4296R3

(E) and (F) SUFFIXES (JEDEC MO-001-AC) 16-Lead Dual-In-Line Plastic or Frit-Seal Ceramic Package

Table with columns: SYMBOL, INCHES (MIN, MAX), NOTE, MILLIMETERS (MIN, MAX). Rows include dimensions A, A1, B, B1, C, D, E, E1, e1, eA, L, L2, a, N, N1, Q1, S.

92CM-15967R4

(E) SUFFIX 18-Lead Dual-In-Line Plastic Package

Table with columns: SYMBOL, INCHES (MIN, MAX), NOTE, MILLIMETERS (MIN, MAX). Rows include dimensions A, A1, B, B1, C, D, E1, e1, eA, L, L2, a, N, N1, S.

92CS-30630

(E) SUFFIX 22-Lead Dual-In-Line Plastic Package

Table with columns: SYMBOL, INCHES (MIN, MAX), NOTE, MILLIMETERS (MIN, MAX). Rows include dimensions A, A1, B, B1, C, D, E, E1, e1, eA, L, L2, a, N, N1, Q1, S.

92CS-30830

(F) SUFFIX (JEDEC MO-001-AG) 16-Lead Dual-In-Line Frit-Seal Ceramic Package

Table with columns: SYMBOL, INCHES (MIN, MAX), NOTE, MILLIMETERS (MIN, MAX). Rows include dimensions A, A1, B, B1, C, D, E, E1, e1, eA, L, L2, a, N, N1, Q1, S.

92CM-22284R1

(E) and (F) SUFFIXES (JEDEC MO-015-AA) 24-Lead Dual-In-Line Plastic or Frit-Seal Ceramic Package

Table with columns: SYMBOL, INCHES (MIN, MAX), NOTE, MILLIMETERS (MIN, MAX). Rows include dimensions A, A1, B, B1, C, D, E, E1, e1, eA, L, L2, a, N, N1, Q1, S.

92CS26938R2

(E) SUFFIX 40-Lead Dual-In-Line Plastic Package

Table with columns: SYMBOL, INCHES (MIN, MAX), NOTE, MILLIMETERS (MIN, MAX). Rows include dimensions A, A1, B, B1, C, D, E1, e1, eA, L, L2, a, N, N1, Q1, S.

92CS-30959

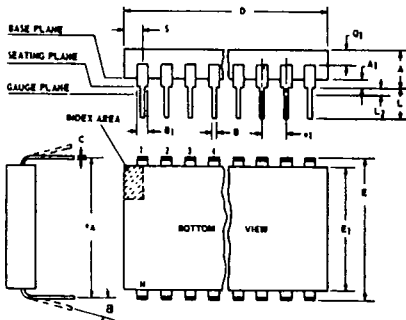

- NOTES: Refer to Rules for Dimensioning (JEDEC Publication No. 95) for Axial Lead Product Outlines. 1. When this device is supplied solder dipped, the maximum lead thickness (narrow portion) will not exceed 0.013". 2. Leads within 0.005" (0.12 mm) radius of True Position (TP) at gauge plane with maximum material condition and unit installed. 3. eA applies in zone L2 when unit installed. 4. a applies to spread leads prior to installation. 5. N is the maximum quantity of lead positions. 6. N1 is the quantity of allowable missing leads.

T-90-20

Dimensional Outlines (Cont'd)

Ceramic Flat Packs

**(K) SUFFIX (JEDEC MO-004-AF)
14-Lead**

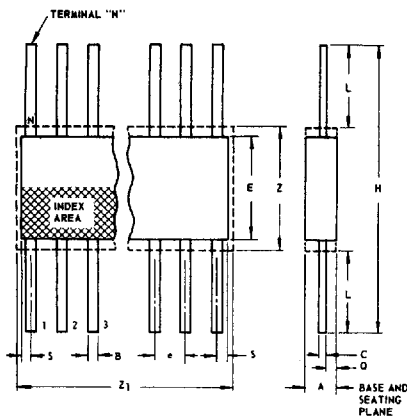

SYMBOL	INCHES		NOTE	MILLIMETERS	
	MIN.	MAX.		MIN.	MAX.
A	0.008	0.100		0.21	2.54
B	0.015	0.019	1	0.381	0.482
C	0.003	0.006	1	0.077	0.152
e	0.050 TP		2	1.27 TP	
E	0.200	0.300		5.1	7.6
H	0.600	1.000		15.3	25.4
L	0.150	0.350		3.9	8.8
N	14		3	14	
Q	0.005	0.050		0.13	1.27
S	0.000	0.050		0.00	1.27
Z	0.300		4	7.62	
Z ₁	0.400		4	10.16	

92SS-4300R3

NOTES:

1. Refer to JEDEC Publication No. 95 for Rules for Dimensioning Peripheral Lead Outlines.
2. Leads within 0.005" (0.12 mm) radius of True Position (TP) at maximum material condition.
3. N is the maximum quantity of lead positions.
4. Z and Z₁ determine a zone within which all body and lead irregularities lie.

**(K) SUFFIX (JEDEC MO-004-AG)
16-Lead**

SYMBOL	INCHES		NOTE	MILLIMETERS	
	MIN.	MAX.		MIN.	MAX.
A	0.008	0.100		0.21	2.54
B	0.015	0.019	1	0.381	0.482
C	0.003	0.006	1	0.077	0.152
e	0.050 TP		2	1.27 TP	
E	0.200	0.300		5.1	7.6
H	0.600	1.000		15.3	25.4
L	0.150	0.350		3.9	8.8
N	16		3	16	
Q	0.005	0.050		0.13	1.27
S	0.000	0.025		0.00	0.63
Z	0.300		4	7.62	
Z ₁	0.400		4	10.16	

92CS-17271R3

**(K) SUFFIX
24-Lead**

SYMBOL	INCHES		NOTE	MILLIMETERS	
	MIN.	MAX.		MIN.	MAX.
A	0.075	0.120		1.91	3.04
B	0.018	0.022	1	0.458	0.558
C	0.004	0.007	1	0.102	0.177
e	0.050 TP		2	1.27 TP	
E	0.600	0.700		15.24	17.78
H	1.150	1.350		29.21	34.29
L	0.225	0.325		5.72	8.25
N	24		3	24	
Q	0.035	0.070		0.89	1.77
S	0.060	0.110	1	1.53	2.79
Z	0.700		4	17.78	
Z ₁	0.750		4	19.05	

92CS-19949R2

**(K) SUFFIX
28-Lead**

SYMBOL	INCHES		NOTE	MILLIMETERS	
	MIN.	MAX.		MIN.	MAX.
A	0.075	0.120		1.91	3.04
B	0.018	0.022	1	0.458	0.558
C	0.004	0.007	1	0.102	0.177
e	0.050 TP		2	1.27 TP	
E	0.600	0.700		15.24	17.78
H	1.150	1.350		29.21	34.29
L	0.225	0.325		5.72	8.25
N	28		3	28	
Q	0.035	0.070		0.89	1.77
S	0	0.060	1	0	1.53
Z	0.700		4	17.78	
Z ₁	0.750		4	19.05	

92CS-20972