

CMOS 21-Stage Counter

High-Voltage Types (20-Volt Rating)

■ CD4045B is a timing circuit consisting of 21 counter stages, two output-shaping flip-flops, two inverter output drivers, and input inverters for use in a crystal oscillator. The CD4045B configuration provides 21 flip-flop counting stages, and two flip-flops for shaping the output waveform for a 3.125% duty cycle. Push-pull operation is provided by the inverter output drivers.

The first inverter is intended for use as a crystal oscillator/amplifier. However, it may be used as a normal logic inverter if desired. A crystal oscillator circuit can be made less sensitive to voltage-supply variations by the use of source resistors. In this device, the sources of the p and n transistors have been brought out to package terminals. If external resistors are not required, the sources must be shorted to their respective substrates (S_p to V_{DD} , S_n to V_{SS}). See Fig. 1. The first inverter in conjunction with an outboard inverter, such as 1/6 CD4069, and R_X , C_X , and R_S can also be used to construct an RC oscillator. The following data is supplied as a guide in the selection of values for R_X , R_S , and C_X used in Fig. 11:

1. R_X max = 10 M Ω with R_S = 10 M Ω and C_X = 50 pF
2. C_X max = 25 μ F with R_S = 560 k Ω and R_X = 50 k Ω

The CD4045B types are supplied in 16-lead dual-in-line plastic packages (E suffix), 16-lead small-outline package (NSR suffix), and 16-lead thin shrink small-outline packages (PW and PWR suffixes).

Applications:

- Digital equipment in which ultra-low dissipation and/or operation using a battery source is required.
- Accurate timing from a crystal oscillator for timing applications such as wall clocks, table clocks, automobile clocks, and digital timing references in any circuit requiring accurately timed outputs at various intervals in the counting sequence.
- Driving miniature synchronous motors, stepping motors, or external bipolar transistors in push-pull fashion.

Features:

- Very low operating dissipation <1 mW (typ.) @ V_{DD} = 5 V, $f\phi$ = 1 MHz
- Output drivers with sink or source capability 7 mA (typ.) @ V_{DD} = 5 V
- Medium speed (typ.) $f\phi$ = 25 MHz @ V_{DD} = 10 V
- 100% tested for quiescent current at 20 V
- 5-V, 10-V, and 15-V parametric ratings
- Meets all requirements of JEDEC Tentative Standard No. 13B, Standard Specifications for Description of 'B' Series CMOS Devices"

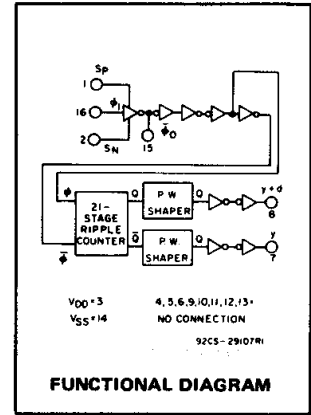

MAXIMUM RATINGS, Absolute-Maximum Values:

DC SUPPLY-VOLTAGE RANGE, (V_{DD})	-0.5V to +20V
Voltages referenced to V_{SS} Terminal	
INPUT VOLTAGE RANGE, ALL INPUTS	-0.5V to V_{DD} + 0.5V
DC INPUT CURRENT, ANY ONE INPUT	\pm 10mA
POWER DISSIPATION PER PACKAGE (P_D):	
For T_A = -55°C to +100°C	500mW
For T_A = +100°C to +125°C	Derate Linearly at 12mW/°C to 200mW
DEVICE DISSIPATION PER OUTPUT TRANSISTOR	
FOR T_A = FULL PACKAGE-TEMPERATURE RANGE (All Package Types)	100mW
OPERATING-TEMPERATURE RANGE (T_A)	-55°C to +125°C
STORAGE TEMPERATURE RANGE (T_{stg})	-85°C to +150°C
LEAD TEMPERATURE (DURING SOLDERING):	
At distance 1/16 \pm 1/32 inch (1.59 \pm 0.79mm) from case for 10s max	+265°C

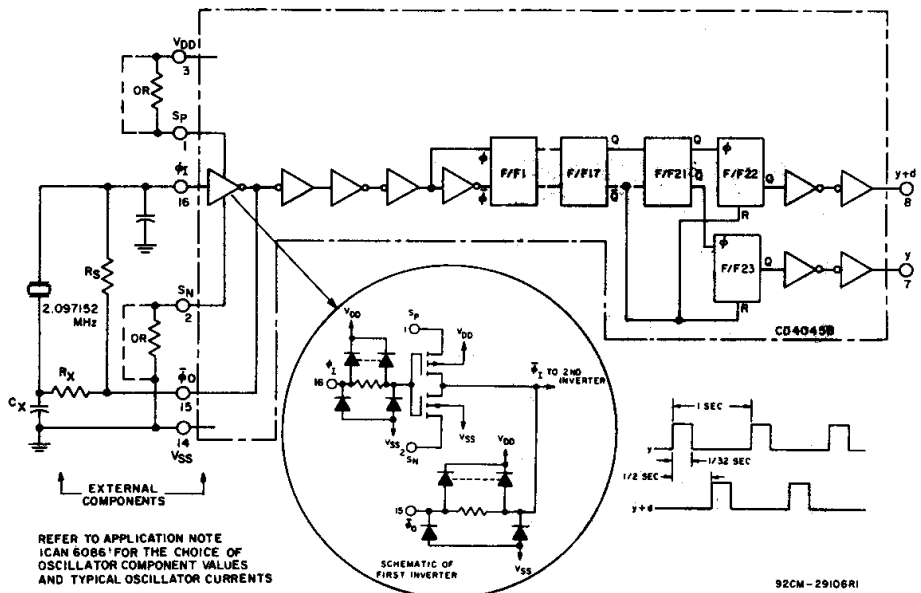

Fig. 1 - CD4045B and outboard components in a typical 21-stage counter application.

CD4045B Types

STATIC ELECTRICAL CHARACTERISTICS

CHARACTERISTIC	CONDITIONS			LIMITS AT INDICATED TEMPERATURES (°C)							UNITS
	V _O (V)	V _{IN} (V)	V _{DD} (V)	-55	-40	+85	+125	+25			
								Min.	Typ.	Max.	
Quiescent Device Current, I _{DD} Max.	—	0,5	5	5	5	150	150	—	0,04	5	μA
	—	0,10	10	10	10	300	300	—	0,04	10	
	—	0,15	15	20	20	600	600	—	0,04	20	
	—	0,20	20	100	100	3000	3000	—	0,08	100	
Output Low (Sink) Current I _{OL} Min.	0,4	0,5	5	4,5	4,3	2,9	2,5	3,6	7	—	mA
	0,5	0,10	10	11,2	10,5	7,7	6,3	9,1	18	—	
	1,5	0,15	15	29,4	28	19,6	16,8	23,8	47	—	
Output High (Source) Current, I _{OH} Min.	4,6	0,5	5	-4,5	-4,3	-2,9	-2,5	-3,6	-7	—	mA
	9,5	0,10	10	-11,2	-10,5	-7,7	-6,3	-9,1	-18	—	
	13,5	0,15	15	-29,4	-28	-19,6	-16,8	-23,8	-47	—	
Pin 15 Output Low and High Current, I _{OL} , I _{OH}	0,4,4,6	0,5	5	—				±0,1	±0,18	—	mA
	0,5,9,5	0,10	10	—				±0,2	±0,3	—	
	1,5,13,5	0,15	15	—				±0,5	±1	—	
Output Voltage: Low-Level, V _{OL} Max.	—	0,5	5	0,05				—	—	0,05	V
	—	0,10	10	0,05				—	—	0,05	
	—	0,15	15	0,05				—	—	0,05	
Output Voltage: High-Level, V _{OH} Min.	—	0,5	5	4,95				4,95	5	—	V
	—	0,10	10	9,95				9,95	10	—	
	—	0,15	15	14,95				14,95	15	—	
Input Low Voltage V _{IL} Max.	0,5,4,5	—	5	1,5				—	—	1,5	V
	1,9	—	10	3				—	—	3	
	1,5,13,5	—	15	4				—	—	4	
Input High Voltage, V _{IH} Min.	0,5,4,5	—	5	3,5				3,5	—	—	V
	1,9	—	10	7				7	—	—	
	1,5,13,5	—	15	11				11	—	—	
Input Current I _{IN} Max.	—	0,18	18	±0,1	±0,1	±1	±1	—	±10 ⁻⁵	±0,1	μA

RECOMMENDED OPERATING CONDITIONS

For maximum reliability, nominal operating conditions should be selected so that operation is always within the following ranges

CHARACTERISTIC	V _{DD} (V)	LIMITS		UNITS
		Min.	Max.	
Supply-Voltage Range (For T _A = Full Package-Temperature Range)	—	3	18	V
Minimum Input-Pulse Width, t _w	5	—	100	ns
	10	—	50	
	15	—	40	
Maximum Input-Pulse Frequency, f _φ (External Pulse Source)	5	5	—	MHz
	10	12	—	
	15	15	—	

3
COMMERCIAL CMOS
HIGH VOLTAGE ICs

CD4045B Types

DYNAMIC ELECTRICAL CHARACTERISTICS at $T_A = 25^\circ\text{C}$; Input $t_r, t_f = 20\text{ ns}$, $C_L = 50\text{ pF}$, $R_L = 200\text{ k}\Omega$

CHARACTERISTIC	TEST CONDITIONS	V_{DD} V	LIMITS			UNITS
			Min.	Typ.	Max.	
Propagation Delay Time: ϕ_1 to y or y+d out t_{PHL}, t_{PLH}		5	—	2.2	5.5	μs
		10	—	0.9	2.7	
		15	—	0.65	2	
Transition Time: t_{THL}, t_{TLH}		5	—	25	50	ns
		10	—	13	25	
		15	—	10	20	
Minimum Input-Pulse Width t_W		5	—	50	100	ns
		10	—	25	50	
		15	—	20	40	
Input-Pulse Rise or Fall Time: $t_r\phi, t_f\phi$		5	—	—	500	μs
		10	—	—	500	
		15	—	—	500	
Maximum Input-Pulse Frequency: (External Pulse Source) f_ϕ		5	5	10	—	MHz
		10	12	25	—	
		15	15	30	—	
Input Capacitance, C_{IN}	Any Input		—	5	7.5	pF
Variation of Output Frequency (Unit-to-Unit)	$f = 5\text{ MHz}$	5	—	0.05	—	%
		10	—	0.03	—	
		15	—	0.1	—	
RC Oscillator Operation						
Maximum Oscillator Frequency (See Fig. 11) f_{osc}	$R_X = 50\text{ k}\Omega$, $R_S = 560\text{ k}\Omega$, $C_X = 50\text{ pF}$	5	45	60	75	kHz
		10	45	60	75	
		15	45	60	75	

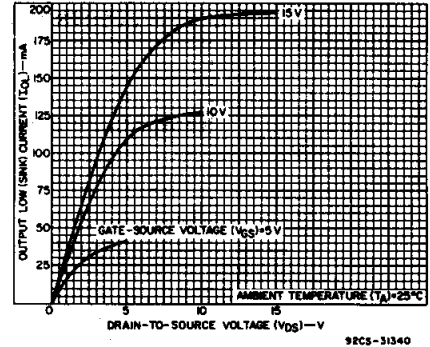

Fig. 2 — Typical output low (sink) current characteristics.

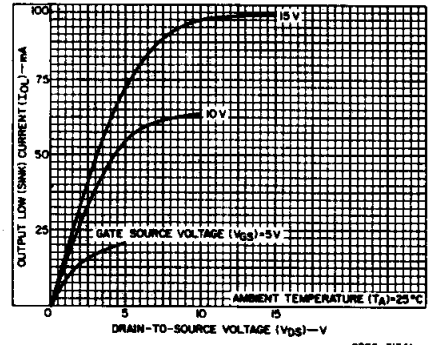

Fig. 3 — Minimum output low (sink) current characteristics.

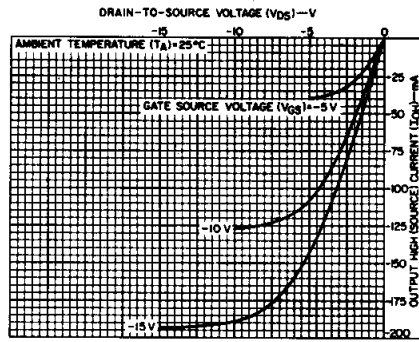

Fig. 4 — Typical output high (source) current characteristics.

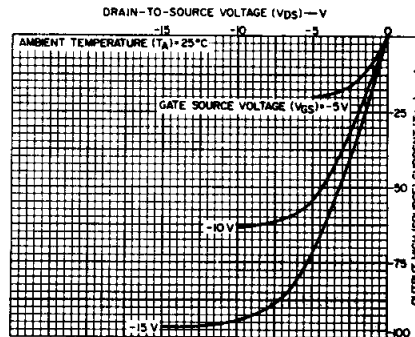

Fig. 5 — Minimum output high (source) current characteristics.

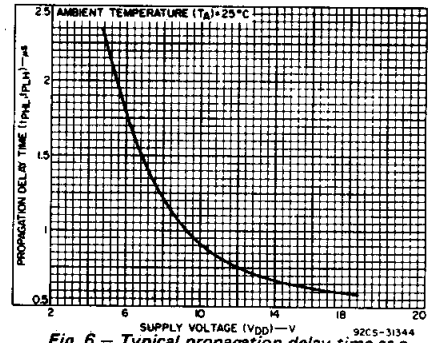

Fig. 6 — Typical propagation delay time as a function of supply voltage (ϕ_1 to y or y + d out vs. V_{DD}).

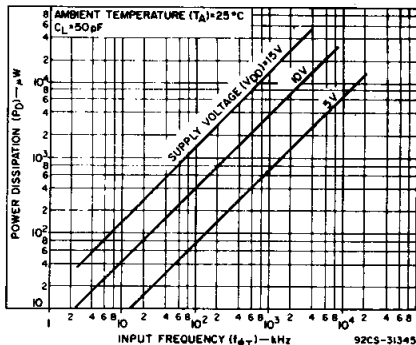

Fig. 7 — Typical power dissipation as a function of input frequency (21 counting stages).

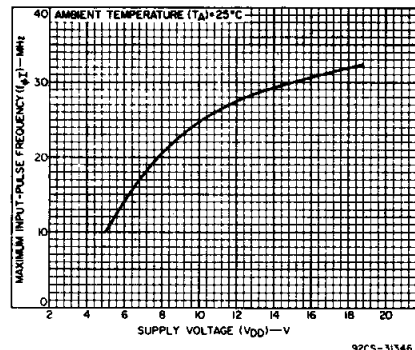

Fig. 8 — Typical maximum input-pulse frequency as a function of supply voltage.

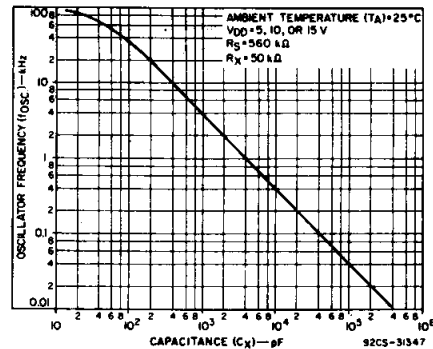

Fig. 9 — Typical RC oscillator frequency as a function of capacitance (C_X). See Fig. 11.

CD4045B Types

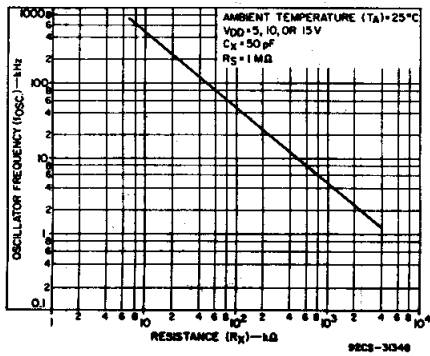

Fig. 10 - Typical RC oscillator frequency as a function of resistance (R_X). See Fig. 11.

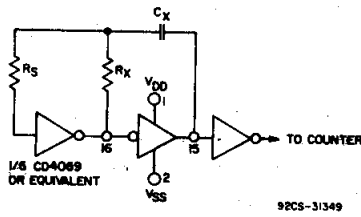

Fig. 11 - Typical RC circuit.

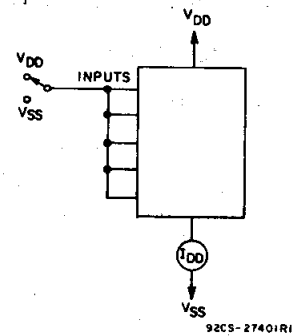

Fig. 12 - Quiescent-device-current test circuit.

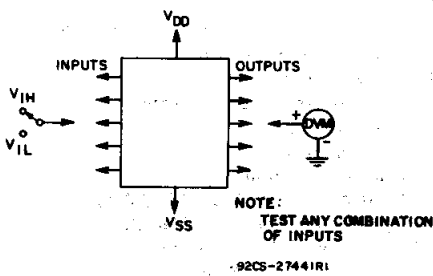

Fig. 13 - Noise-immunity test circuit.

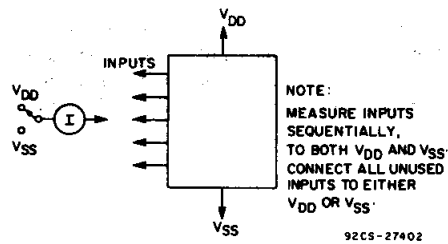

Fig. 14 - Input-leakage-current test circuit.

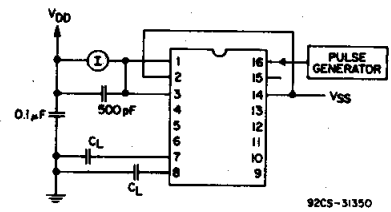
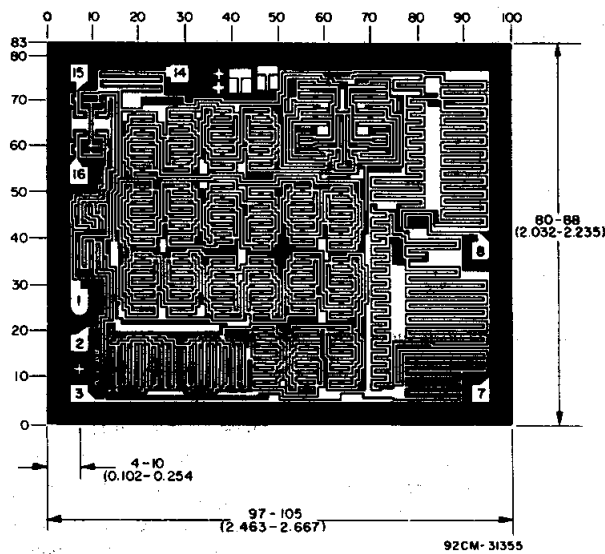

Fig. 15 - Dynamic power dissipation test circuit.



Chip dimensions and pad layout for CD4045B

Dimensions in parentheses are in millimeters and are derived from the basic inch dimensions as indicated. Grid graduations are in mils (10^{-3} inch).

TERMINAL DIAGRAM Top View

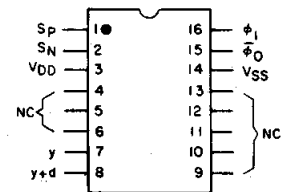

NC = NO CONNECTION

NOTE: Observe power-supply terminal connections, V_{DD} is terminal No. 3 and V_{SS} is terminal No. 14 (not 16 and 8 respectively, as in other CD4000B Series 16-lead devices).

3
COMMERCIAL CMOS
HIGH VOLTAGE ICs

PACKAGING INFORMATION

Orderable Device	Status (1)	Package Type	Package Drawing	Pins	Package Qty	Eco Plan (2)	Lead finish/ Ball material (6)	MSL Peak Temp (3)	Op Temp (°C)	Device Marking (4/5)	Samples
CD4045BE	ACTIVE	PDIP	N	16	25	RoHS & Green	NIPDAU	N / A for Pkg Type	-55 to 125	CD4045BE	Samples

(1) The marketing status values are defined as follows:

ACTIVE: Product device recommended for new designs.

LIFEBUY: TI has announced that the device will be discontinued, and a lifetime-buy period is in effect.

NRND: Not recommended for new designs. Device is in production to support existing customers, but TI does not recommend using this part in a new design.

PREVIEW: Device has been announced but is not in production. Samples may or may not be available.

OBSELETE: TI has discontinued the production of the device.

(2) **RoHS:** TI defines "RoHS" to mean semiconductor products that are compliant with the current EU RoHS requirements for all 10 RoHS substances, including the requirement that RoHS substance do not exceed 0.1% by weight in homogeneous materials. Where designed to be soldered at high temperatures, "RoHS" products are suitable for use in specified lead-free processes. TI may reference these types of products as "Pb-Free".

RoHS Exempt: TI defines "RoHS Exempt" to mean products that contain lead but are compliant with EU RoHS pursuant to a specific EU RoHS exemption.

Green: TI defines "Green" to mean the content of Chlorine (Cl) and Bromine (Br) based flame retardants meet JS709B low halogen requirements of <=1000ppm threshold. Antimony trioxide based flame retardants must also meet the <=1000ppm threshold requirement.

(3) MSL, Peak Temp. - The Moisture Sensitivity Level rating according to the JEDEC industry standard classifications, and peak solder temperature.

(4) There may be additional marking, which relates to the logo, the lot trace code information, or the environmental category on the device.

(5) Multiple Device Markings will be inside parentheses. Only one Device Marking contained in parentheses and separated by a "-" will appear on a device. If a line is indented then it is a continuation of the previous line and the two combined represent the entire Device Marking for that device.

(6) Lead finish/Ball material - Orderable Devices may have multiple material finish options. Finish options are separated by a vertical ruled line. Lead finish/Ball material values may wrap to two lines if the finish value exceeds the maximum column width.

Important Information and Disclaimer:The information provided on this page represents TI's knowledge and belief as of the date that it is provided. TI bases its knowledge and belief on information provided by third parties, and makes no representation or warranty as to the accuracy of such information. Efforts are underway to better integrate information from third parties. TI has taken and continues to take reasonable steps to provide representative and accurate information but may not have conducted destructive testing or chemical analysis on incoming materials and chemicals. TI and TI suppliers consider certain information to be proprietary, and thus CAS numbers and other limited information may not be available for release.

In no event shall TI's liability arising out of such information exceed the total purchase price of the TI part(s) at issue in this document sold by TI to Customer on an annual basis.

N (R-PDIP-T**)

PLASTIC DUAL-IN-LINE PACKAGE

16 PINS SHOWN



- NOTES:
- A. All linear dimensions are in inches (millimeters).
 - B. This drawing is subject to change without notice.
 - $\triangle C$ Falls within JEDEC MS-001, except 18 and 20 pin minimum body length (Dim A).
 - $\triangle D$ The 20 pin end lead shoulder width is a vendor option, either half or full width.

4040049/E 12/2002

IMPORTANT NOTICE AND DISCLAIMER

TI PROVIDES TECHNICAL AND RELIABILITY DATA (INCLUDING DATASHEETS), DESIGN RESOURCES (INCLUDING REFERENCE DESIGNS), APPLICATION OR OTHER DESIGN ADVICE, WEB TOOLS, SAFETY INFORMATION, AND OTHER RESOURCES "AS IS" AND WITH ALL FAULTS, AND DISCLAIMS ALL WARRANTIES, EXPRESS AND IMPLIED, INCLUDING WITHOUT LIMITATION ANY IMPLIED WARRANTIES OF MERCHANTABILITY, FITNESS FOR A PARTICULAR PURPOSE OR NON-INFRINGEMENT OF THIRD PARTY INTELLECTUAL PROPERTY RIGHTS.

These resources are intended for skilled developers designing with TI products. You are solely responsible for (1) selecting the appropriate TI products for your application, (2) designing, validating and testing your application, and (3) ensuring your application meets applicable standards, and any other safety, security, or other requirements. These resources are subject to change without notice. TI grants you permission to use these resources only for development of an application that uses the TI products described in the resource. Other reproduction and display of these resources is prohibited. No license is granted to any other TI intellectual property right or to any third party intellectual property right. TI disclaims responsibility for, and you will fully indemnify TI and its representatives against, any claims, damages, costs, losses, and liabilities arising out of your use of these resources.

TI's products are provided subject to TI's Terms of Sale (www.ti.com/legal/termsofsale.html) or other applicable terms available either on ti.com or provided in conjunction with such TI products. TI's provision of these resources does not expand or otherwise alter TI's applicable warranties or warranty disclaimers for TI products.

Mailing Address: Texas Instruments, Post Office Box 655303, Dallas, Texas 75265
Copyright © 2020, Texas Instruments Incorporated