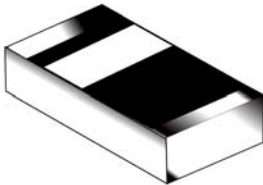

**Switching Diode****CD4148WN****FEATURES**

- Silicon epitaxial planar diode
- SMD chip pattern, available in various dimension included 0805
- Leadfree and RoHS compliance components
- For AC switching input as rectified circuit and high reverse voltage location

**MECHANICAL CHARACTERISTICS**

- Size: 1206
- Weight: approx. 10mg
- Marking: Cathode terminal

**DIMENSIONS**

Dimension/mm	1206
L	3.2±0.2
W	1.5±0.2
T	0.85±0.1
C	0.55±0.2

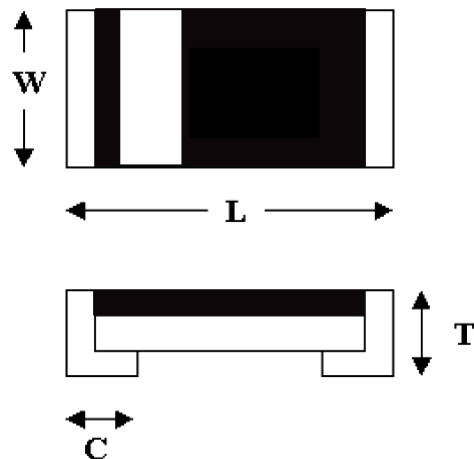
**THERMAL CHARACTERISTICS<sup>1)</sup>**

Parameter at $T_{amb}=25^{\circ}C^{1)}$	Symbol	Value	Unit
Forward Power Dissipation Power derating above 25°C	$P_{tot}$	400	mW
		3.2	mW/°C
Junction Temperature	$T_j$	150	°C
Thermal Resistance Junction to Ambient air	$R_{\theta JA}$	375	°C/W
Operating & Storage Temperature range	$T_{stg}$	-55 to 150	°C

1) Valid provided that electrodes are kept at ambient temperature.

**MAXIMUM RATING<sup>1)</sup>**

Parameter at T <sub>amb</sub> =25°C <sup>1)</sup>	Symbol	Value	Unit
Repetitive Peak Reverse Voltage	V <sub>RRM</sub>	100	V
Average rectified current sin half wave rectification with resistive load	I <sub>F(AV)</sub>	150	mA
Repetitive Peak Forward Current at T <sub>amb</sub> =25°C	I <sub>FRM</sub>	300	mA
Non-Repetitive Surge Forward Current at t<1s and T <sub>j</sub> =25°C at t≤8.3ms and T <sub>j</sub> =25°C	I <sub>FSM</sub>	500	mA
		1000	mA

1) Valid provided that electrodes are kept at ambient temperature.

**ELECTRICAL CHARACTERISTICS<sup>1)</sup>**

Parameter at T <sub>amb</sub> =25°C <sup>1)</sup>	Symbol	Value	Unit
Forward Voltage at I <sub>F</sub> =10mA at I <sub>F</sub> =100mA	V <sub>F</sub>	1.0 <sub>MAX</sub>	V
		1.25 <sub>MAX</sub>	V
Leakage Current at V <sub>R</sub> =20V	I <sub>R</sub>	0.025 <sub>MAX</sub>	uA
Leakage Current at V <sub>R</sub> =80V		0.5 <sub>MAX</sub>	uA
Capacitance at V <sub>R</sub> =0V, f=1MHz	C <sub>tot</sub>	4 <sub>MAX</sub>	pF
Reverse Recovery Time at I <sub>F</sub> =I <sub>R</sub> =10mA, R <sub>L</sub> =100Ω	t <sub>rr</sub>	4 <sub>MAX</sub>	ns

1) Valid provided that electrodes are kept at ambient temperature.

**TYPICAL CHARACTERISTICS**

Figure 1. Forward Characteristic

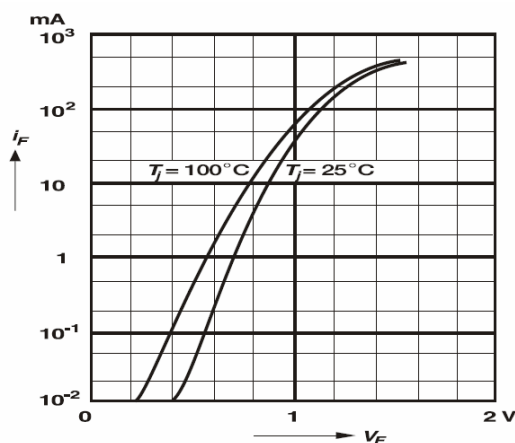

Figure 2. Power De-rating

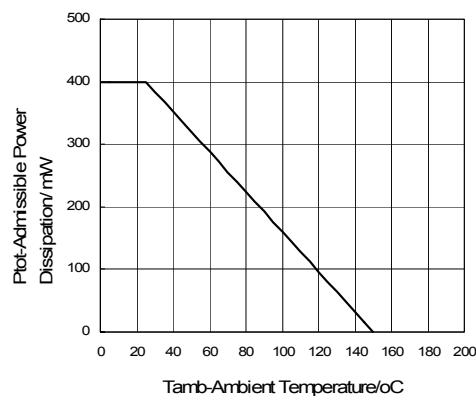



Figure 3. Forward Current De-rating

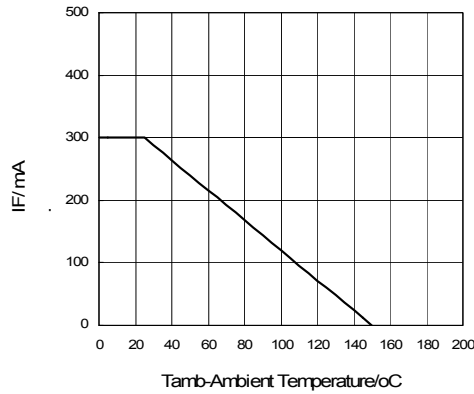
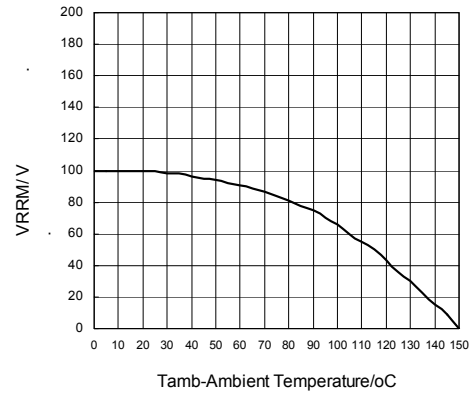

Figure 4. Reverse Voltage De-rating



TEST CHARACTERISTICS

Test Item	Test Condition	Requirement
Solderability	Sn bath at 245±5°C for 2±0.5s	>95% area tin covered
Resistance to Soldering Heat	Sn bath at 260±5°C for 10±2s	V <sub>F</sub> , V <sub>R</sub> & I <sub>R</sub> within spec; no mechanical damage
Humidity Steady State	At 85°C 85%RH for 168hrs	V <sub>F</sub> , V <sub>R</sub> & I <sub>R</sub> within spec
Continue Forward Operating Life	At 25°C I <sub>F</sub> = 1.1I <sub>F</sub> for 1000hrs	V <sub>F</sub> , V <sub>R</sub> & I <sub>R</sub> within spec
Thermal Shock	-55 ±5°C/5min to 150±5°C/5min for 10cycles	V <sub>F</sub> , V <sub>R</sub> & I <sub>R</sub> within spec
Bending Strength	Bending up to 2mm for 1cycle	V <sub>F</sub> , V <sub>R</sub> & I <sub>R</sub> within spec; no mechanical damage



APPLICATIONS

- Function: Fast switching, suit for AC switching input as rectified circuit and high reverse voltage location application
- Typical Application circuit:

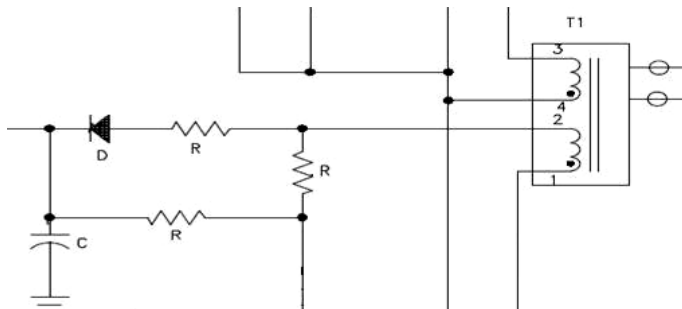

- Typical Product field: Power supply, adapter & inverter

- Soldering Condition:

Soldering Condition & Caution

- Recommended Soldering Condition  
(Refer to IPC/JEDEC J-STD-020D 4-1&5.2)

Recommended Profile Condition	Sn-Pb Soldering	Leadfree Soldering	Wave Soldering
Ramp-up rate (from pre-heat stage)	<3°C/s	<3°C/s	ΔT<150°C
Pre-heat Temperature & Time	100-150 °C 60-120s	150-200 °C 60-120s	100-150 °C 60-120s
Soldering Temperature & Time	183 °C 60-150s	217 °C 60-150s	260±5°C 5±2s
Peak Temperature	230±5°C <260°C	245±5°C <260°C	260±5°C
Time within 5°C of peak temperature	10-20s	20-30s	-
Ramp-down rate	<6°C/s	<6°C/s	<6°C/s
Time 25°C to peak temperature	<6min	<8min	-

Manual Soldering: Approx. 350°C for 3s, avoid solder iron tip direct touch the components body



Recommended Soldering Profile

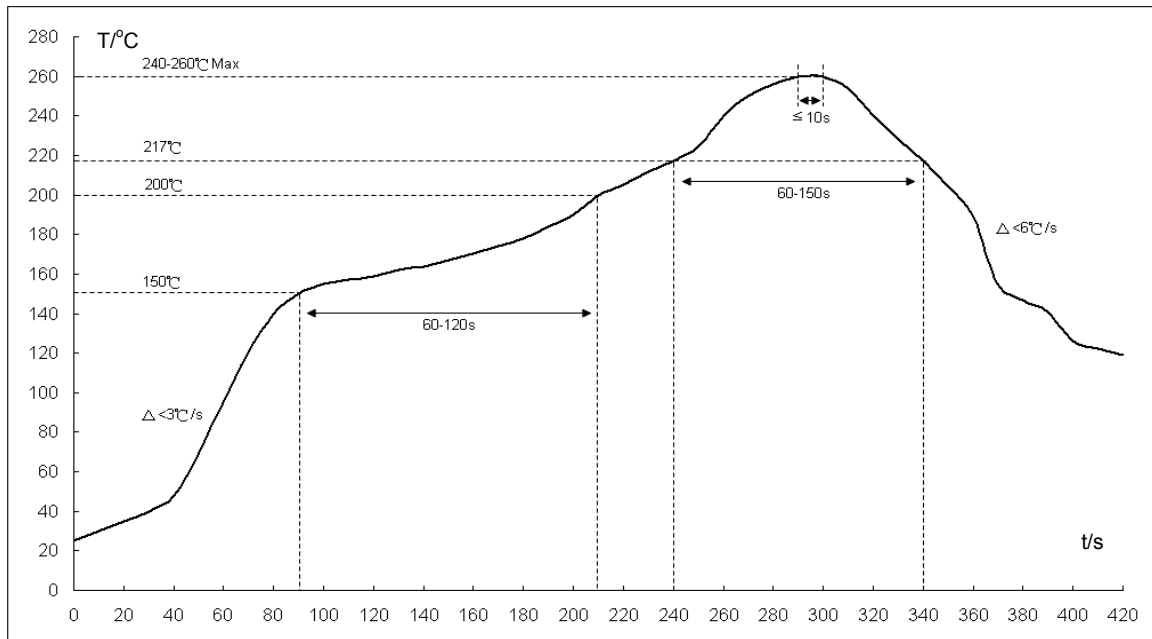

Fig1: Reflow soldering profile for lead-free solder (SnAgCu)

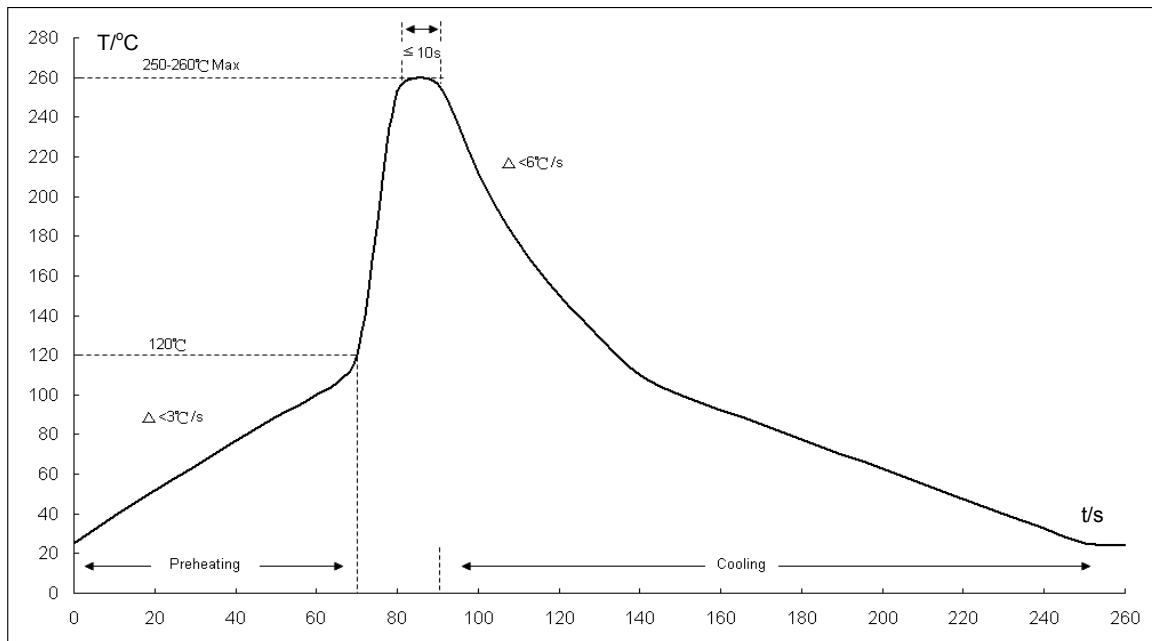
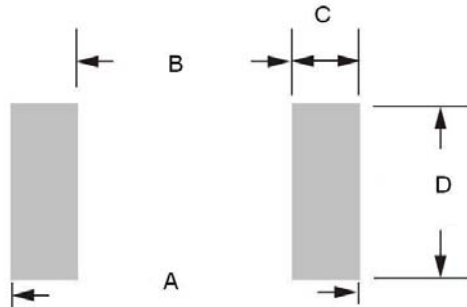

Fig2: Wave soldering profile

- \*1. The recommended profiles are referring to IPC/JEDEC J-STD-020D & IEC-60068-2-58
- \*2. Chip diodes are able to stand maximum soldering temperature up to 260°C max for 10s, and the soldering cycles with max 3 times, referring to IEC-60068-2-58



- Recommended Soldering Footprint:



- Reflow/Wave Soldering

Product Size	Dimension/ mm			
	A	B	C	D
1206	3.8-4.6	2.2	0.8-1.2	1.5-1.7

- Storage Condition: Product termination solderability can degrade due to high temperature and humidity or chemical environment. Storage condition must be in an ambient temperature of <40°C and ambient humidity of <75%RH, and free from chemical.

### ENVIRONMENTAL CHARACTERISTICS

Product	Hazardous Substance or Element/ppm					
	Pb	Cd	Hg	Cr <sup>6+</sup>	PBB	PBDE
	<1000	<100	<1000	<1000	<1000	<1000

Product	Halogen Substance/ ppm				
	F	Cl	Br	I	Total
	<900	<900	<900	<900	<1500

### PACKING METHOD

Product	Quality/Reel	Reel Size	Tape
	5,000pcs	7"	Paper

### DISCLAIMERS

These products are not designed for use in applications where any failure or malfunction may result in personal injury, death or severe property or environmental damage such as medical, military, aircraft, space or life support equipments.