

SINLOON® 高壓貼片開關二極管
Chip Switching Diode

CD4148WN (1206)
100V 0.15A

FEATURE

- Silicon epitaxial planar diode (矽平面磊晶技術)
- Surface mount pattern , available in various dimension included 0805 & 0603 (網印塑封表面封裝工藝,制成不同封裝型號 0805 和 0603 易於選用,)
- Lead free and RoHS compliance components. (無鉛制程符合RoHS環保要求條件)
- Fast AC switching input as rectified circuit and high reverse voltage location. (快速開關作為糾正輸入電路和很高的反向電壓位置)

Figure



Cathode Band Color: white

MECHANICAL CHARACTERISTICS

- Size : 1206
- Weight: Approx 10mg.
- Marking: Cathode band.



Electrical Symbol

DIMENSION

Dimension (mm)	Type: 1206
L	3.2 ± 0.2
W	1.50 ± 0.2
T	0.85 ± 0.1
C	0.55 ± 0.2

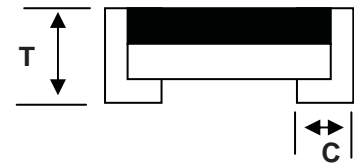
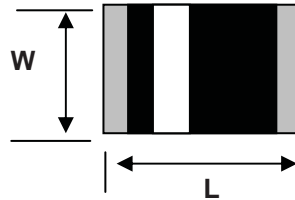

THERMAL CHARACTERISTICS

Parameter at Tamb = 25°C *1	Symbol	Value	Unit
Junction Temperature	T _j	150	°C
Thermal Resistance Junction to Ambient air	R _{θJA}	375	°C/W
Storage Temperature range	T _{stg}	-55 to 150	°C

*1. Valid provided that electrodes are kept at ambient temperature.

ELECTRICAL CHARACTERISTICS

Parameter at Tamb = 25°C ¹	Symbol	Value	Unit
Repetitive Peak Reverse Voltage	V _{RRM} (VPK)	100	V
Forward Continuous Current _{amb=25°C}	I _{FRM}	300	mA
Average rectified current sin half wave rectification with resistive load	I _{F(AV)}	150	mA
Non-Repetitive Surge Forward Current at t<1s and T _j =25°C; at t≤8.3ms and T _j =25°C.	I _{FSM}	500 1000	mA
Forward Power Dissipation	P _{tot}	400	mW
Power derating above 25°C.		3.2	mW/°C
Forward Voltage at I _F =10mA	V _F	1.0 max	V
Forward Voltage at I _F =100mA		1.25 max	
Leakage Current at V _R =20V	I _R	25 max	nA
Leakage Current at V _R =75V		0.5 max	μA
Capacitance at V _R =0V, f=1MHz.	C _{tot}	4 max	pF
Voltage rise when switching ON, Testes with 50mA pulses, T _P =0.1us, rise time <20ns, F _p =(5-	V _{fr}	2.5 max	V
Reverse Recovery Time at I _F =100mA to I _R =1mA, V _R =V6, R _L =100Ω	T _{RR}	4.0 max	ns
Rectification efficiency at f=100MHz, V _{RF} =2V	nr	45 min	%

1. Valid provided that electrodes are kept at ambient temperature.



SINLOON® 高壓貼片開關二極管
Chip Switching Diode

CD4148WN (1206)
100V 0.15A

TEST CHARACTERISTICS:

Test Item	Test Condition	Requirement
Solderability	Sn bath at 245±5°C for 2±0.5s	>95% area tin covered
Resistance to Soldering Heat	Sn bath at 260±5°C for 10±0.5s	V _F , V _Z , & I _R Within spec, no mechanical damage
Humidity Steady State	At 85°C 85%RH for 168hrs	V _F , V _Z , & I _R Within spec
Continue Forward Operating Life	At 25°C I _F = 1.1 I _F for 1000hrs	V _F , V _Z , & I _R Within spec
Hi-Temperature Reverse Bias	At 150°C V _R = 0.8V _R rated for 1000hrs	V _F , V _Z , & I _R Within spec
Thermal Shock	-55±5°C/5min to 150±5°C/5min for 10cycles	V _F , V _Z , & I _R Within spec
Bending Strength	Bending up to 2mm for 1 cycle	V _F , V _Z , & I _R Within spec, no mechanical damage

APPLICATIONS:

- Function: Fast Switching.
- Soldering Condition:

Soldering Condition & Caution:

- Recommended Soldering Condition (Refer to IPC/JEDEC J-STD-020D 5-1)

Recommended Profile Condition	Sn-Pb Soldering	Lead-free Soldering	Wave Soldering
Ramp-up rate (from pre-heat stage)	<3°C/s	<3°C/s	ΔT<150°C
Pre-heat Temperature & Time	100-150°C, 60~120s	100-200°C, 60~120s	100-150°C, 60~120s
Soldering Temperature & Time	183°C, 60~150s	270°C, 60~150s	260±5°C, 5±2s
Peak Temperature	230±5°C, <260°C	245±5°C, <260°C	260±5°C
Time within 5°C of peak temperature	10~20s	20~30s	-
Ramp-down rate	<6°C/s	<6°C/s	<6°C/s
Time 25°C to peak temperature	<6min	<8min	-

Manual Soldering: Approx. 350°C for 3s, avoid solder iron tip direct touch the components body.

RECTIFICATION EFFICIENCY MEASUREMENT CIRCUIT

※Fast AC switching input as rectified circuit and high reverse voltage location.

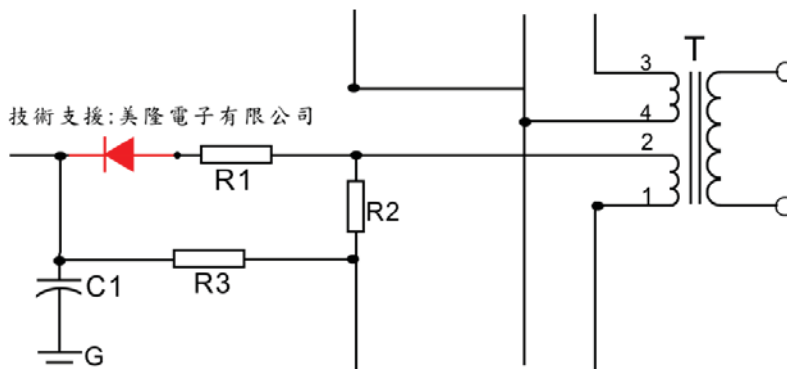

DEVICE OUTLOOK:

Plant front side



Plant back side



PRODUCT STRUCTURE

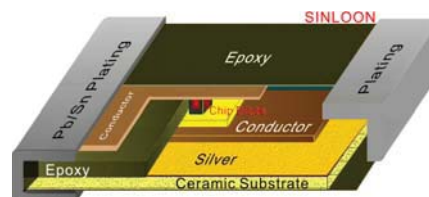

SINLOON® 高壓貼片開關二極管
Chip Switching Diode

CD4148WN (1206)
100V 0.15A

□ **TYPICAL CHARACTERISTICS**

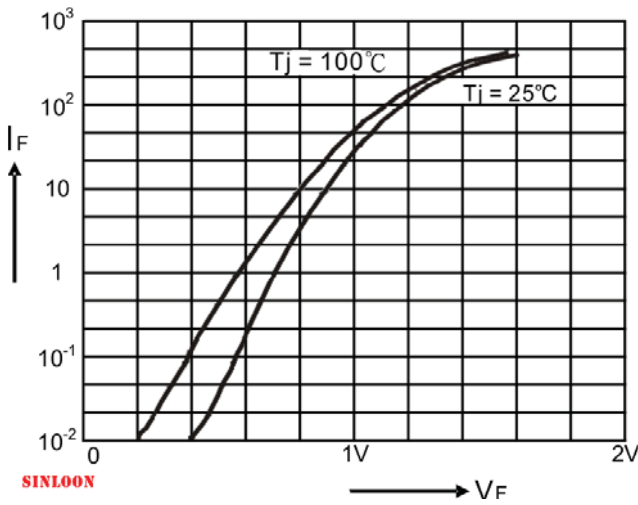

Figure 1 : Forward Characteristics

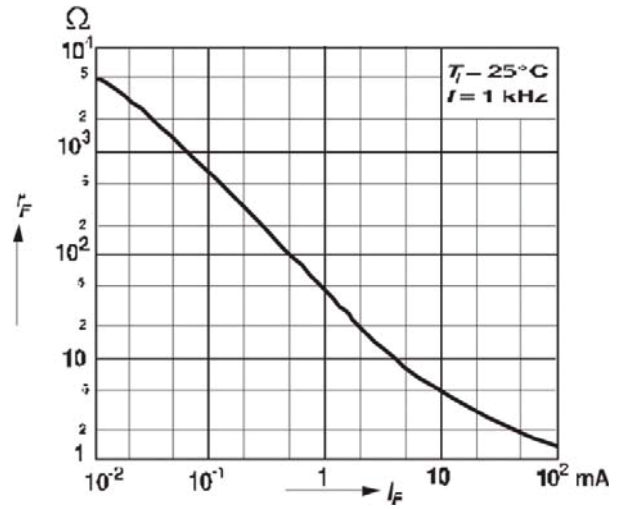

Figure 2 : Dynamic Forward Resistor VS Forward Current

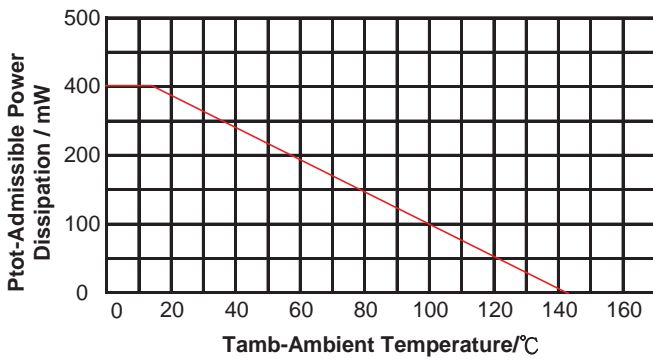

Figure 3 : Power De-rating

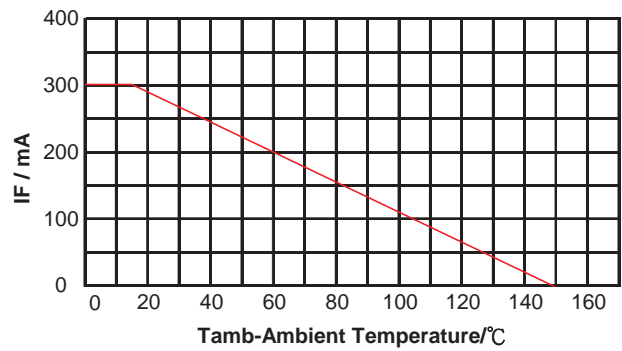

Figure 4 : Forward Current De-rating

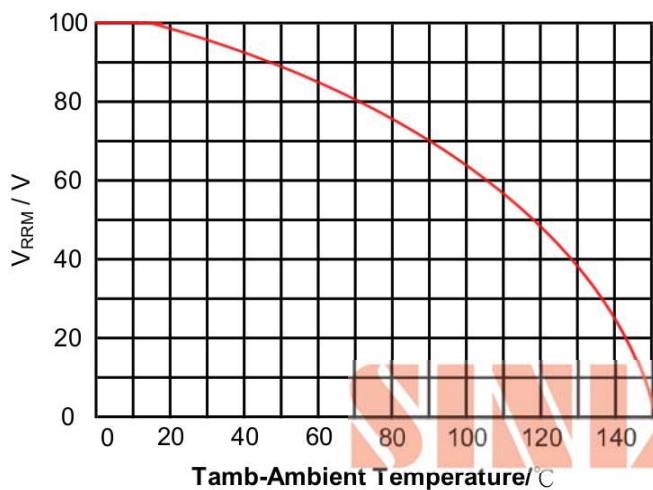

Figure 5 : Reverse Voltage De-rating



**SINLOON® 高壓貼片開關二極管
Chip Switching Diode**

**CD4148WN (1206)
100V 0.15A**

RECOMMENDED SOLDERING PROFILE:

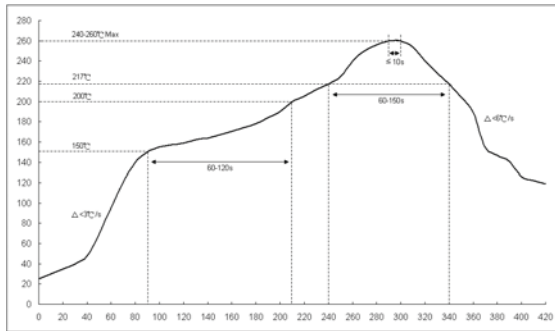

Fig 1: Reflow soldering profile for lead-free solder (SnAgCu)

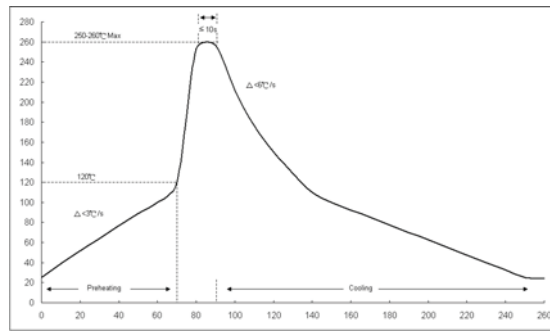

Fig 2: Wave soldering profile.

* The recommended profiles are referring to IPC/JEDEC J-STD-020D & IEC-60068-2-58
* Chip diode are to stabd maximum soldering temperture up to 260°C max. for 10s, and the soldering cycles with max. 3 times, referring to IEC-60068-2-58

RECOMMENDED SOLDERING FOOTPRINT

Reflow/Wave Soldering:

Size:	Dimension (mm)			
	A	B	C	D
0603	1.8~2.6	0.8	0.5~0.9	0.8~1.0
0805	2.2~3.0	1.2	0.5~0.9	1.2~1.4
1206	3.4~4.2	2.1~2.2	0.6~1.0	1.5~1.7

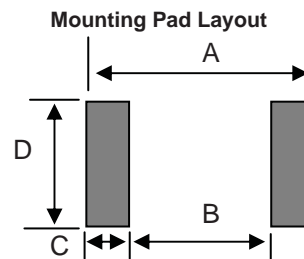

■ Storage Condition: Product termination solderability can degrade due high temperature and humidity or chemical environment, Storage condition must be in an ambient temperature of <40°C and ambient humidity of <75%RH, and free from chemical.

ENVIRONMENTAL CHARACTERISTICS

Product	Hazerdous Substance or Element / ppm					
	Pd	Cd	Hg	Cr ⁶⁺	PBB	PBDE
CD4148WTP	<1000	<100	<1000	<1000	<1000	<1000
CD4148WSN	<1000	<100	<1000	<1000	<1000	<1000
CD4148WN	<1000	<100	<1000	<1000	<1000	<1000
Product	Halogen Substance / ppm					
	F	Cl	Br	I	-	Total
	<900	<900	<900	<900	-	<1500

PACKING METHOD:

Product	Quantity / Reel	Reel Size	Tape	Approx Gross Weigh
CD4148WTP	5000	7"	Paper	10.5 Kgs/300K Ctn
CD4148WSN	5000	7"	Paper	10.5 Kgs/300K Ctn
CD4148WN	5000	7"	Paper	13.0 Kgs/300K Ctn

Carton:

Size: 39x39x20 cm
Quantity: 300K / Ctn.
Inner Box: 6 Box
Box Quantity: 50K/Box
Type Reel: 5K/Reel

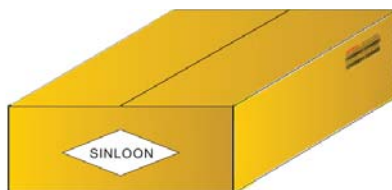

SINLOON® 高壓貼片開關二極管
Chip Switching Diode

CD4148WN (1206)
100V 0.15A

PACKAGE

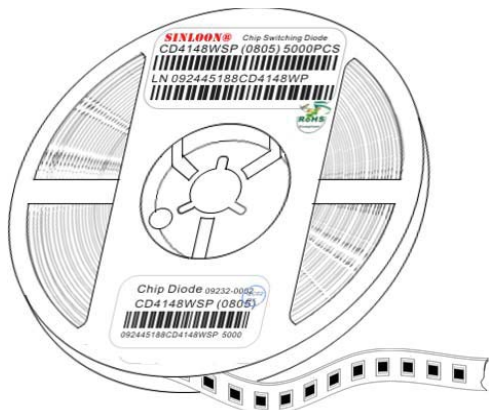

Plastic reel front side

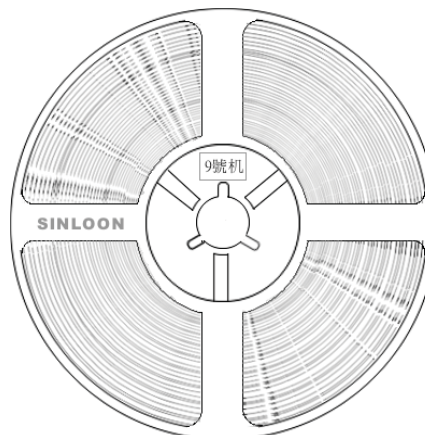

Plastic reel back side

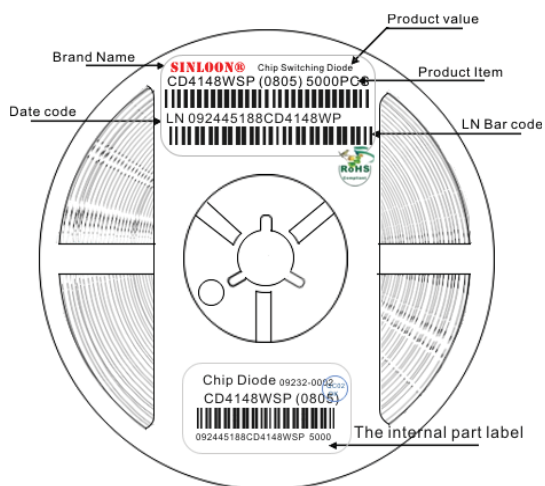

Reel label

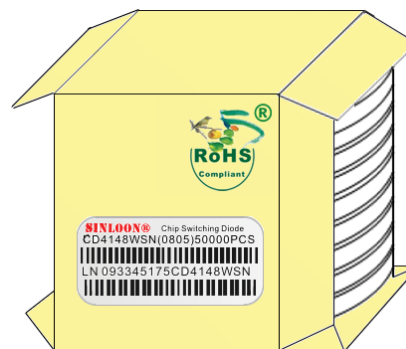

In box packing

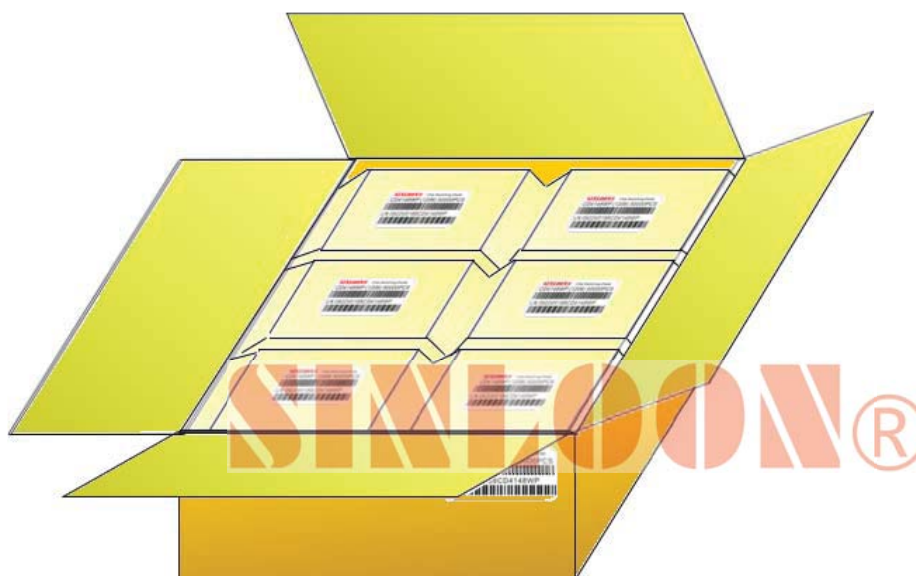

Carton Packing

※美隆公司產品規格及其特性參數的改變或更新恕不另行通知。

※Mayloon characteristic parameters of electronic product specification changes or updates without notice to improve.