

**SINLOON® 貼片型開關二極管**  
**Small Signal Chip Switching Diode**

**CD4148WTP (0603)**  
**75V 0.15A**

**FEATURE:**

- This diode is also available in case styles including the 1206 case with the designation. CD4148WP and the 0805 case with the type designation CD4148WSP.
- Silicon Epitaxial Planar Diode.
- Lead free and RoHS compliance components.
- Fast switching diode.

**MECHANICAL CHARACTERISTICS:**

- Size : 0603
- Weight: Approx 4.0mg.
- Marking: Cathode band.

**DIMENSION**

Dimension (mm)	Type: 0603
L	1.55 ± 0.1
W	0.8 ± 0.1
T	0.65 ± 0.1
C	0.35 ± 0.2

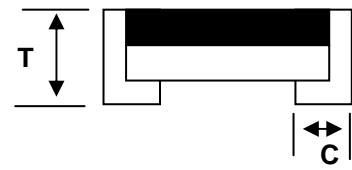
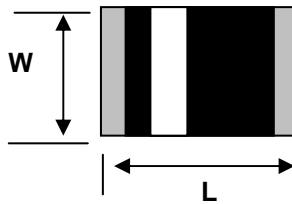

Figure



Cathode Band Color: white



Electrical Symbol

**THERMAL CHARACTERISTICS:**

Parameter at Tamb = 25°C	Symbol	Value	Unit
Junction Temperature	T <sub>j</sub>	175	°C
Thermal Resistance Junction to Ambient air	R <sub>θJA</sub>	375 <sup>1</sup>	°C/W
Storage Temperature range	T <sub>stg</sub>	-65 to 175 <sup>1</sup>	°C

1. Valid provided that electrodes are kept at ambient temperature.

**ELECTRICAL CHARACTERISTICS**

Parameter at Tamb = 25°C	Symbol	Value	Unit
Reverse Voltage:	V <sub>R</sub>	75	V
Peak Reverse Voltage:	V <sub>RM</sub>	100	V
Forward Continuous Current:	I <sub>FM</sub>	300	mA
Average rectified current sin half wave rectification with resistive load f>50Hz	I <sub>F(AV)</sub>	150 <sup>1</sup>	mA
Surge Forward Current at t<1s and T <sub>j</sub> =25°C	I <sub>FSM</sub>	500	mA
Power Dissipation	P <sub>tot</sub>	400 <sup>1</sup>	mW
Forward Voltage at I <sub>F</sub> =100mA	V <sub>F</sub>	1.0 max	V
Leakage Current at V <sub>R</sub> =20V	I <sub>R</sub>	25 max	nA
Leakage Current at V <sub>R</sub> =75V	I <sub>R</sub>	5 max	µA
Leakage Current at V <sub>R</sub> =20V, T <sub>J</sub> =150°C	I <sub>R</sub>	50 max	µA
Capacitance at V <sub>F</sub> =V <sub>R</sub> =0V	C <sub>tot</sub>	4 max	pF
Voltage rise when switching ON, Testes with 50mA pulses, T <sub>P</sub> =0.1µs, risetime <20ns, F <sub>p</sub> =(5-100)KHz.	V <sub>fr</sub>	2.5 max	V
Reverse Recovery Time at I <sub>F</sub> =100mA to I <sub>R</sub> =1mA, V <sub>R</sub> =V <sub>6</sub> , R <sub>L</sub> =100Ω	t <sub>rr</sub>	4.0 max	ns
Rectification efficiency at f=100MHz, V <sub>RF</sub> =2V	n <sub>r</sub>	45 min	%

1. Valid provided that electrodes are kept at ambient temperature.



**SINLOON® 貼片型開關二極管**  
**Small Signal Chip Switching Diode**

**CD4148WTP (0603)**  
**75V 0.15A**

**TEST CHARACTERISTICS**

Test Item	Test Condition	Requirement
Solder ability	Sn bath at 245±5°C for 2±0.5s	>95% area tin covered
Resistance to Soldering Heat	Sn bath at 260±5°C for 10±0.5s	V <sub>F</sub> , V <sub>Z</sub> , & I <sub>R</sub> Within spec, no mechanical damage
Humidity Steady State	At 85°C 85%RH for 168hrs	V <sub>F</sub> , V <sub>Z</sub> , & I <sub>R</sub> Within spec
Continue Forward Operating Life	At 25°C I <sub>F</sub> = 1.1 I <sub>F</sub> for 1000hrs	V <sub>F</sub> , V <sub>Z</sub> , & I <sub>R</sub> Within spec
Hi-Temperature Reverse Bias	At 150°C V <sub>R</sub> = 0.8V <sub>R</sub> rated for 1000hrs	V <sub>F</sub> , V <sub>Z</sub> , & I <sub>R</sub> Within spec
Thermal Shock	-55±5°C/5min to 150±5°C/5min for 10cycles	V <sub>F</sub> , V <sub>Z</sub> , & I <sub>R</sub> Within spec
Bending Strength	Bending up to 2mm for 1 cycle	V <sub>F</sub> , V <sub>Z</sub> , & I <sub>R</sub> Within spec, no mechanical damage

**APPLICATIONS**

- Function: Fast Switching.
- Soldering Condition:

**Soldering Condition & Caution**

- Recommended Soldering Condition (Refer to IPC/JEDEC J-STD-020D 5-1)

Recommended Profile Condition	Sn-Pb Soldering	Lead-free Soldering	Wave Soldering
Ramp-up rate (from pre-heat stage)	<3°C/s	<3°C/s	ΔT<150°C
Pre-heat Temperature & Time	100-150°C, 60~120s	100-200°C, 60~120s	100-150°C, 60~120s
Soldering Temperature & Time	183°C, 60~150s	270°C, 60~150s	260±5°C, 5±2s
Peak Temperature	230±5°C, <260°C	245±5°C, <260°C	260±5°C
Time within 5°C of peak temperature	10~20s	20~30s	-
Ramp-down rate	<6°C/s	<6°C/s	<6°C/s
Time 25°C to peak temperature	<6min	<8min	-

Manual Soldering: Approx. 350°C for 3s, avoid solder iron tip direct touch the components body.

**APPLICATION CIRCUIT**

- General application except high reverse voltage location

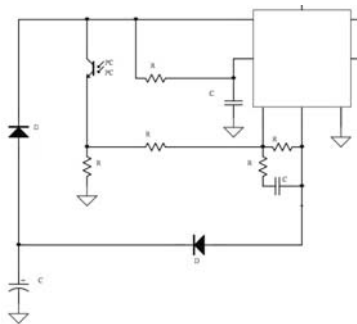

**PRODUCT STRUCTURE**

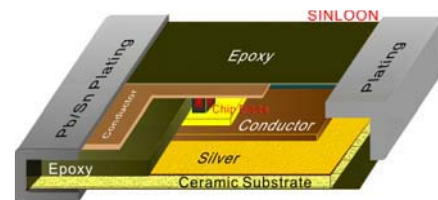

**DEVICE OUTLOOK**

Plant front side



Plant back side

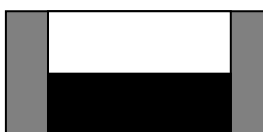

SINLOON® 貼片型開關二極管  
Small Signal Chip Switching Diode

CD4148WTP (0603)  
75V 0.15A

□ TYPICAL CHARACTERISTICS (Tamb=25°C unless otherwise specified)

Figure 1. Forward Characteristics

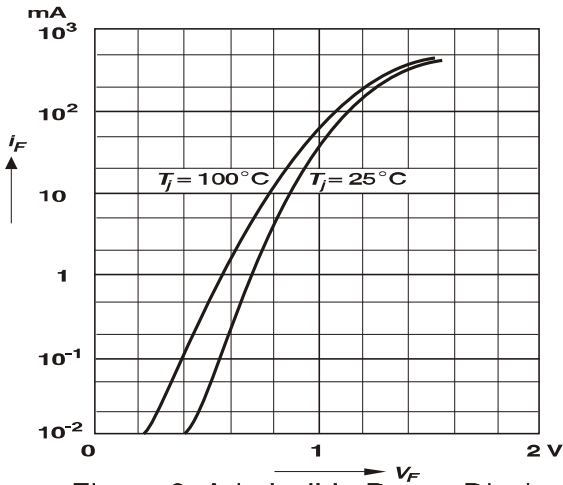

Figure 2. Dynamic Forward Resistance vs. Forward Current

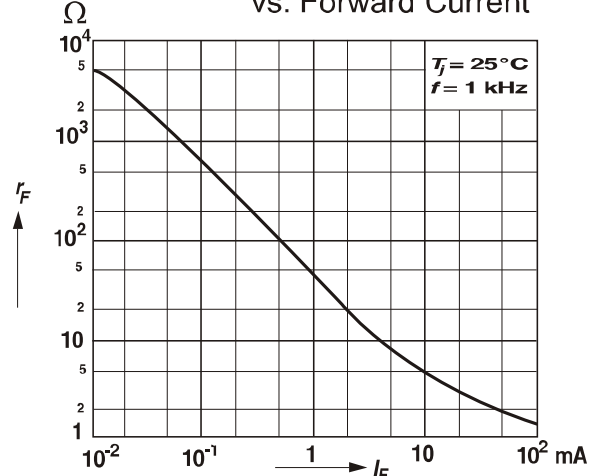

Figure 3. Admissible Power Dissipation vs. Ambient Temperature

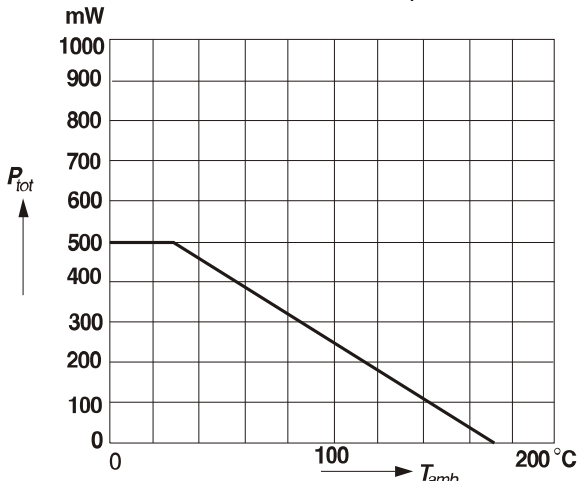

Figure 4. Relative Capacitance vs. Reverse Voltage

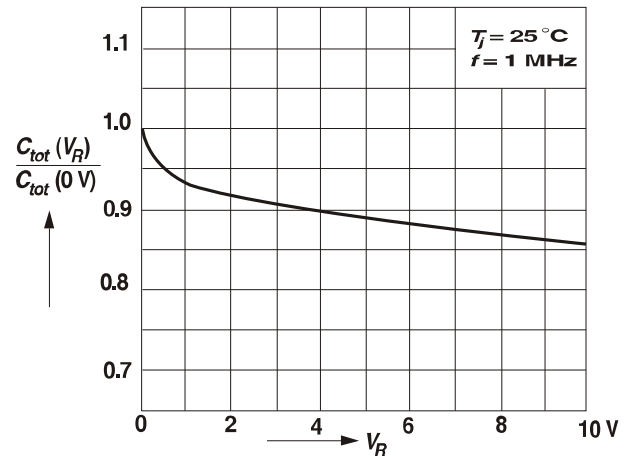

Figure 5. Leakage Current vs. Junction Temperature

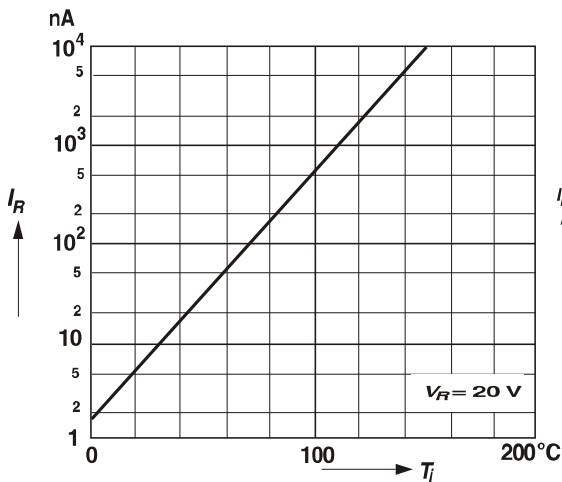
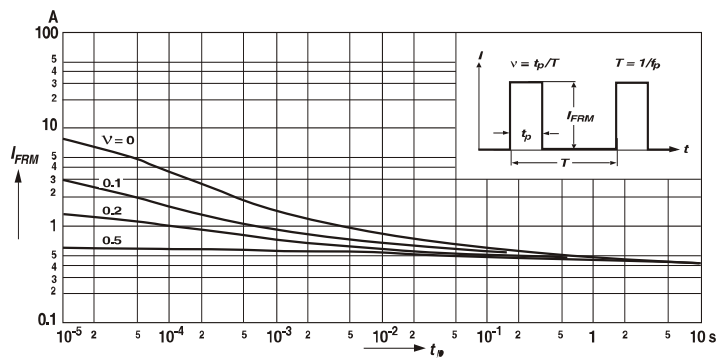

Figure 6. Admissible Repetitive Peak Forward Current vs. Pulse Duration



- 1). The recommended profiles are referring to IPC/JEDEC J-STD-020D & IEC-600068-2-58
- 2). Chip diode are able to stand maximum soldering temperature up to 260°C max for 10s, and the soldering cycles with max 3 times, referring to IEC-60068-2-58.



**SINLOON® 貼片型開關二極管**  
**Small Signal Chip Switching Diode**

**CD4148WTP (0603)**  
**75V 0.15A**

**RECOMMENDED SOLDERING PROFILE:**

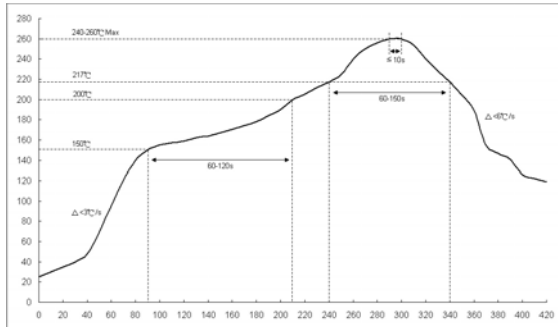

Fig 1: Reflow soldering profile for lead-free solder (SnAgCu)

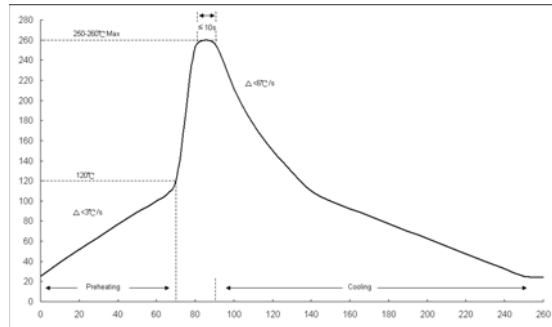

Fig 1: Wave soldering profile.

**RECOMMENDED SOLDERING FOOTPRINT**

Refloe/Wave Soldering:

Size:	Dimension (mm)			
	A	B	C	D
0603	1.8~2.6	0.8	0.5~0.9	0.8~1.0
0805	2.2~3.0	1.2	0.5~0.9	1.2~1.4
1206	3.4~4.2	2.1~2.2	0.6~1.0	1.5~1.7

**Mounting Pad Layout**

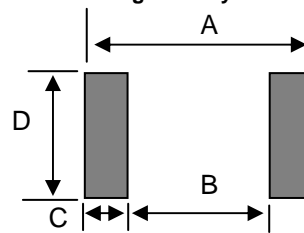

- Storage Condition:** Product termination solderability can degrade due high temperature and humidity or chemical environment, Storage condition must be in an ambient temperature of <40°C and ambient humidity of <75%RH, and free from chemical.

**ENVIRONMENTAL CHARACTERISTICS**

Product	Hazardous Substance or Element / ppm					
	Pd	Cd	Hg	Cr <sup>6+</sup>	PBB	PBDE
CD4148WTP	<1000	<100	<1000	<1000	<1000	<1000
CD4148WS	<1000	<100	<1000	<1000	<1000	<1000
CD4148WP	<1000	<100	<1000	<1000	<1000	<1000
Product	Halogen Substance / ppm					
	F	Cl	Br	I	-	Total
	<900	<900	<900	<900	-	<1500

**PACKING METHOD:**

Product	Quantity / Reel	Reel Size	Tape	Approx Gross Weigh
CD4148WTP	5000	7"	Paper	10.5 Kgs/300K Ctn
CD4148WS	5000	7"	Paper	10.5 Kgs/300K Ctn
CD4148WP	5000	7"	Paper	13.0 Kgs/300K Ctn

**Carton:**

Size: 39x39x20 cm  
Quantity: 300K / Ctn.  
In Box: 6 Box  
Box Qty: 50K/Box  
Reel: 5K/Reel

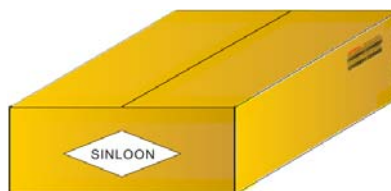

MAYLOON ELECTRONIC CO., LTD.,

**SINLOON® 貼片型開關二極管**  
**Small Signal Chip Switching Diode**

**CD4148WTP (0603)**  
**75V 0.15A**

**PACKAGING (Figure)**

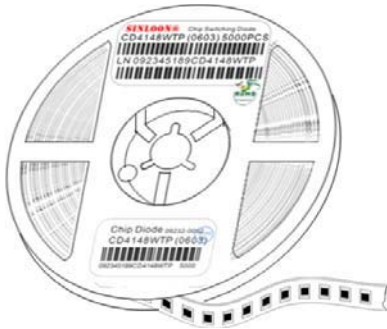

Plastic reel front side

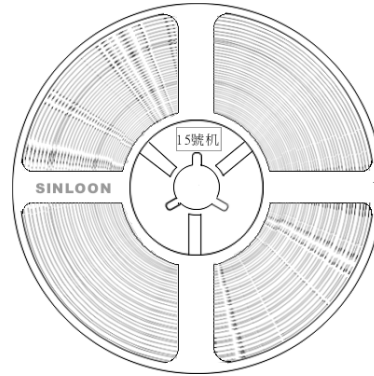

Plastic reel back side

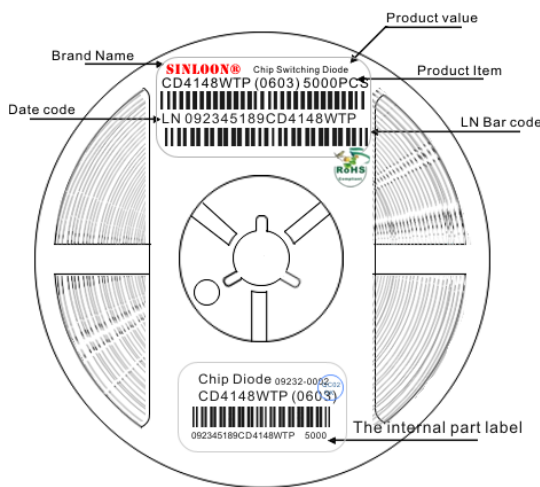

Reel Label

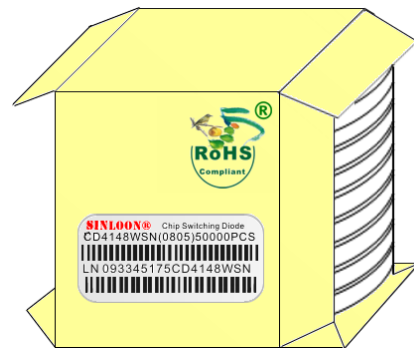

In side box packing

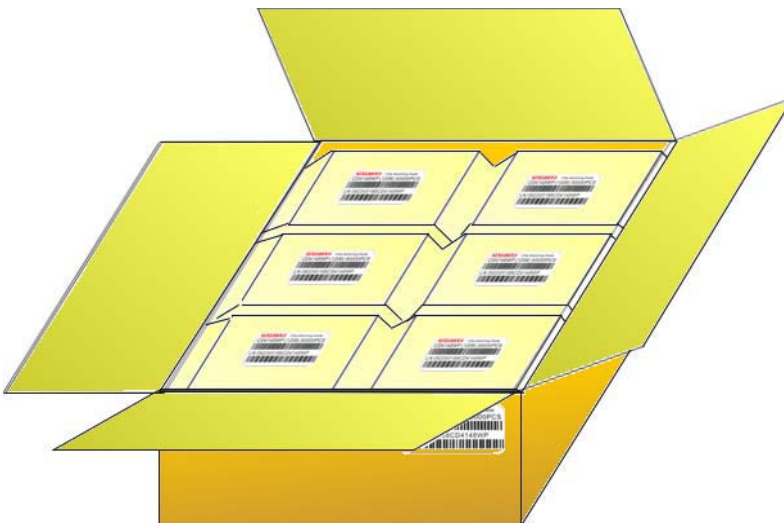

Carton packing

※美隆電子產品規格特性參數的改變或更新,將不會另行通知。

※Mayloon characteristic parameters of electronic product specification changes or updates without prior notice。

