

**CD4503BMS**

CMOS Hex Buffer

FN3335  
Rev 0.00  
December 1992

CD4503BMS is a hex noninverting buffer with 3 state outputs having high sink and source current capability. Two disable controls are provided, one of which controls four buffers and the other controls the remaining two buffers.

The CD4503BMS is supplied in these 16-lead outline packages:

Braze Seal DIP	H4T
Frit Seal DIP	H1E
Ceramic Flatpack	H6W

**Features**

- High Voltage Type (20V Rating)
- 3 State Non-Inverting Type
- 1 TTL Load Output Drive Capability
- 2 Output Disable Controls
- 3 State Outputs
- Pin Compatible with Industry Types MM80C97, MC14503, and 340097
- 5V, 10V and 15V Parametric Ratings
- Maximum Input Current of 1 $\mu$ A at 18V Over Full Package Temperature Range; 100nA at 18V and +25 $^{\circ}$ C
- Meets All Requirements of JEDEC Tentative Standard No. 13B, "Standard Specifications for Description of 'B' Series CMOS Devices"

**Applications**

- 3 State Hex Buffer for Interfacing ICs with Data Buses
- COS/MOS to TTL Hex Buffer

**Pinout**

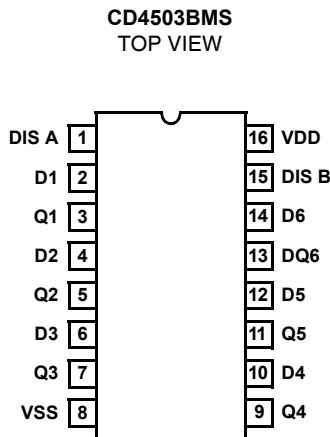

**Functional Diagram**

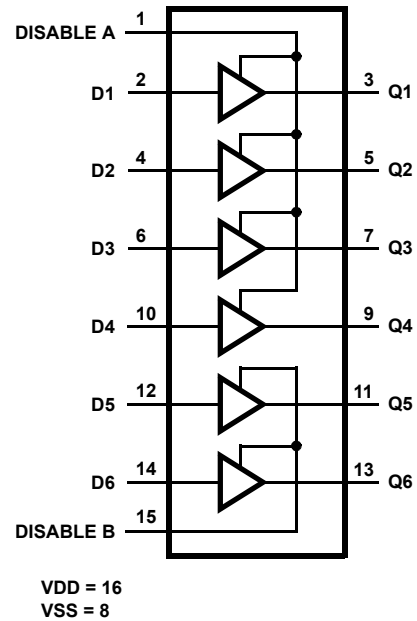

**Absolute Maximum Ratings**

DC Supply Voltage Range, (VDD) . . . . . -0.5V to +20V  
 (Voltage Referenced to VSS Terminals)  
 Input Voltage Range, All Inputs . . . . . -0.5V to VDD +0.5V  
 DC Input Current, Any One Input . . . . . ±10mA  
 Operating Temperature Range . . . . . -55°C to +125°C  
 Package Types D, F, K, H  
 Storage Temperature Range (TSTG) . . . . . -65°C to +150°C  
 Lead Temperature (During Soldering) . . . . . +265°C  
 At Distance 1/16 ± 1/32 Inch (1.59mm ± 0.79mm) from case for  
 10s Maximum

**Reliability Information**

Thermal Resistance . . . . .  $\theta_{ja}$   $\theta_{jc}$   
 Ceramic DIP and FRIT Package . . . . . 80°C/W 20°C/W  
 Flatpack Package . . . . . 70°C/W 20°C/W  
 Maximum Package Power Dissipation (PD) at +125°C  
 For TA = -55°C to +100°C (Package Type D, F, K) . . . . . 500mW  
 For TA = +100°C to +125°C (Package Type D, F, K) . . . . . Derate  
 Linearity at 12mW/°C to 200mW  
 Device Dissipation per Output Transistor . . . . . 100mW  
 For TA = Full Package Temperature Range (All Package Types)  
 Junction Temperature . . . . . +175°C

**TABLE 1. DC ELECTRICAL PERFORMANCE CHARACTERISTICS**

PARAMETER	SYMBOL	CONDITIONS (NOTE 1)		GROUP A SUBGROUPS	TEMPERATURE	LIMITS		UNITS
						MIN	MAX	
Supply Current	IDD	VDD = 20V, VIN = VDD or GND		1	+25°C	-	2	µA
				2	+125°C	-	200	µA
		VDD = 18V, VIN = VDD or GND		3	-55°C	-	2	µA
Input Leakage Current	IIL	VIN = VDD or GND	VDD = 20	1	+25°C	-100	-	nA
			VDD = 18V	2	+125°C	-1000	-	nA
				3	-55°C	-100	-	nA
Input Leakage Current	IIH	VIN = VDD or GND	VDD = 20	1	+25°C	-	100	nA
			VDD = 18V	2	+125°C	-	1000	nA
				3	-55°C	-	100	nA
Output Voltage	VOL15	VDD = 15V, No Load		1, 2, 3	+25°C, +125°C, -55°C	-	50	mV
Output Voltage	VOH15	VDD = 15V, No Load (Note 3)		1, 2, 3	+25°C, +125°C, -55°C	14.95	-	V
Output Current (Sink)	IOL5	VDD = 5V, VOUT = 0.4V		1	+25°C	2.1	-	mA
Output Current (Sink)	IOL10	VDD = 10V, VOUT = 0.5V		1	+25°C	5.5	-	mA
Output Current (Sink)	IOL15	VDD = 15V, VOUT = 1.5V		1	+25°C	16.1	-	mA
Output Current (Source)	IOH5A	VDD = 5V, VOUT = 4.6V		1	+25°C	-	-1.02	mA
Output Current (Source)	IOH5B	VDD = 5V, VOUT = 2.5V		1	+25°C	-	-4.8	mA
Output Current (Source)	IOH10	VDD = 10V, VOUT = 9.5V		1	+25°C	-	-2.6	mA
Output Current (Source)	IOH15	VDD = 15V, VOUT = 13.5V		1	+25°C	-	-6.8	mA
N Threshold Voltage	VNTH	VDD = 10V, ISS = -10µA		1	+25°C	-2.8	-0.7	V
P Threshold Voltage	VPTH	VSS = 0V, IDD = 10µA		1	+25°C	0.7	2.8	V
Functional	F	VDD = 2.8V, VIN = VDD or GND		7	+25°C	VOH > VDD/2	VOL < VDD/2	V
		VDD = 20V, VIN = VDD or GND		7	+25°C			
		VDD = 18V, VIN = VDD or GND		8A	+125°C			
		VDD = 3V, VIN = VDD or GND		8B	-55°C			
Input Voltage Low (Note 2)	VIL	VDD = 5V, VOH > 4.5V, VOL < 0.5V		1, 2, 3	+25°C, +125°C, -55°C	-	1.5	V
Input Voltage High (Note 2)	VIH	VDD = 5V, VOH > 4.5V, VOL < 0.5V		1, 2, 3	+25°C, +125°C, -55°C	3.5	-	V
Input Voltage Low (Note 2)	VIL	VDD = 15V, VOH > 13.5V, VOL < 1.5V		1, 2, 3	+25°C, +125°C, -55°C	-	4	V
Input Voltage High (Note 2)	VIH	VDD = 15V, VOH > 13.5V, VOL < 1.5V		1, 2, 3	+25°C, +125°C, -55°C	11	-	V
Tri-State Output Leakage	IOZL	VIN = VDD or GND VOUT = 0V	VDD = 20V	1	+25°C	-0.4	-	µA
			VDD = 18V	2	+125°C	-12	-	µA
				3	-55°C	-0.4	-	µA
Tri-State Output Leakage	IOZH	VIN = VDD or GND VOUT = VDD	VDD = 20V	1	+25°C	-	0.4	µA
			VDD = 18V	2	+125°C	-	12	µA
				3	-55°C	-	0.4	µA

NOTES: 1. All voltages referenced to device GND, 100% testing being implemented. 2. Go/No Go test with limits applied to inputs. 3. For accuracy, voltage is measured differentially to VDD. Limit is 0.050V max.

TABLE 2. AC ELECTRICAL PERFORMANCE CHARACTERISTICS

PARAMETER	SYMBOL	CONDITIONS	GROUP A SUBGROUPS	TEMPERATURE	LIMITS		UNITS
					MIN	MAX	
Propagation Delay	TPHL	VDD = 5V, VIN = VDD or GND (Note 1, 2)	9	+25°C	-	110	ns
			10, 11	+125°C, -55°C	-	149	ns
Propagation Delay	TPLH	VDD = 5V, VIN = VDD or GND (Note 1, 2)	9	+25°C	-	150	ns
			10, 11	+125°C, -55°C	-	203	ns
Propagation Delay3 State	TPHZ TPZH	VDD = 5V, VIN = VDD or GND (Note 2, 3)	9	+25°C	-	140	ns
			10, 11	+125°C, -55°C	-	189	ns
Propagation Delay3 State	TPZL TPLZ	VDD = 5V, VIN = VDD or GND (Note 2, 3)	9	+25°C	-	180	ns
			10, 11	+125°C, -55°C	-	243	ns
Transition Time	TTHL	VDD = 5V, VIN = VDD or GND (Note 1, 2)	9	+25°C	-	70	ns
			10, 11	+125°C, -55°C	-	95	ns
Transition Time	TTLH	VDD = 5V, VIN = VDD or GND (Note 1, 2)	9	+25°C	-	90	ns
			10, 11	+125°C, -55°C	-	122	ns

## NOTES:

1. CL = 50pF, RL = 200K, Input TR, TF < 20ns.
2. -55°C and +125°C limits guaranteed, 100% testing being implemented.
3. CL = 50pF, RL = 1K, Input TR, TF < 20ns.

TABLE 3. ELECTRICAL PERFORMANCE CHARACTERISTICS

PARAMETER	SYMBOL	CONDITIONS	NOTES	TEMPERATURE	LIMITS		UNITS
					MIN	MAX	
Supply Current	IDD	VDD = 5V, VIN = VDD or GND	1, 2	-55°C, +25°C	-	1	μA
				+125°C	-	30	μA
		VDD = 10V, VIN = VDD or GND	1, 2	-55°C, +25°C	-	2	μA
				+125°C	-	60	μA
		VDD = 15V, VIN = VDD or GND	1, 2	-55°C, +25°C	-	2	μA
				+125°C	-	120	μA
Output Voltage	VOL	VDD = 5V, No Load	1, 2	+25°C, +125°C, -55°C	-	50	mV
Output Voltage	VOL	VDD = 10V, No Load	1, 2	+25°C, +125°C, -55°C	-	50	mV
Output Voltage	VOH	VDD = 5V, No Load	1, 2	+25°C, +125°C, -55°C	4.95	-	V
Output Voltage	VOH	VDD = 10V, No Load	1, 2	+25°C, +125°C, -55°C	9.95	-	V
Output Current (Sink)	IOL5	VDD = 5V, VOUT = 0.4V	1, 2	+125°C	1.3	-	mA
				-55°C	2.6	-	mA
Output Current (Sink)	IOL10	VDD = 10V, VOUT = 0.5V	1, 2	+125°C	3.8	-	mA
				-55°C	6.5	-	mA
Output Current (Sink)	IOL15	VDD = 15V, VOUT = 1.5V	1, 2	+125°C	11.2	-	mA
				-55°C	19.2	-	mA
Output Current (Source)	IOH5A	VDD = 5V, VOUT = 4.6V	1, 2	+125°C	-	-0.7	mA
				-55°C	-	-1.2	mA
Output Current (Source)	IOH5B	VDD = 5V, VOUT = 2.5V	1, 2	+125°C	-	-3.0	mA
				-55°C	-	-5.8	mA
Output Current (Source)	IOH10	VDD = 10V, VOUT = 9.5V	1, 2	+125°C	-	-1.8	mA
				-55°C	-	-3.1	mA
Output Current (Source)	IOH15	VDD = 15V, VOUT = 13.5V	1, 2	+125°C	-	-4.8	mA
				-55°C	-	-8.2	mA

TABLE 3. ELECTRICAL PERFORMANCE CHARACTERISTICS (Continued)

PARAMETER	SYMBOL	CONDITIONS	NOTES	TEMPERATURE	LIMITS		UNITS
					MIN	MAX	
Input Voltage Low	VIL	VDD = 10V, VOH > 9V, VOL < 1V	1, 2	+25°C, +125°C, -55°C	-	3	V
Input Voltage High	VIH	VDD = 10V, VOH > 9V, VOL < 1V	1, 2	+25°C, +125°C, -55°C	+7	-	V
Propagation Delay	TPHL	VDD = 10V	1, 2, 3	+25°C	-	50	ns
		VDD = 15V	1, 2, 3	+25°C	-	35	ns
Propagation Delay	TPLH	VDD = 10V	1, 2, 3	+25°C	-	70	ns
		VDD = 15V	1, 2, 3	+25°C	-	50	ns
Propagation Delay	TPHZ TPZH	VDD = 10V	1, 2, 4	+25°C	-	60	ns
		VDD = 15V	1, 2, 4	+25°C	-	50	ns
Propagation Delay	TPZL TPLZ	VDD = 10V	1, 2, 4	+25°C	-	80	ns
		VDD = 15V	1, 2, 4	+25°C	-	70	ns
Transition Time	TTHL	VDD = 10V	1, 2, 3	+25°C	-	40	ns
		VDD = 15V	1, 2, 3	+25°C	-	25	ns
Transition Time	TTLH	VDD = 10V	1, 2, 3	+25°C	-	45	ns
		VDD = 15V	1, 2, 3	+25°C	-	35	ns
Input Capacitance	CIN	Any Inputs	1, 2	+25°C	-	7.5	pF

## NOTES:

- All voltages referenced to device GND.
- The parameters listed on Table 3 are controlled via design or process and are not directly tested. These parameters are characterized on initial design release and upon design changes which would affect these characteristics.
- CL = 50pF, RL = 200K, Input TR, TF < 20ns.
- CL = 50pF, RL = 1K, Input TR, TF < 20ns.

TABLE 4. POST IRRADIATION ELECTRICAL PERFORMANCE CHARACTERISTICS

PARAMETER	SYMBOL	CONDITIONS	NOTES	TEMPERATURE	LIMITS		UNITS
					MIN	MAX	
Supply Current	IDD	VDD = 20V, VIN = VDD or GND	1, 4	+25°C	-	7.5	μA
N Threshold Voltage	VNTH	VDD = 10V, ISS = -10μA	1, 4	+25°C	-2.8	-0.2	V
N Threshold Voltage Delta	ΔVTN	VDD = 10V, ISS = -10μA	1, 4	+25°C	-	±1	V
P Threshold Voltage	VTP	VSS = 0V, IDD = 10μA	1, 4	+25°C	0.2	2.8	V
P Threshold Voltage Delta	ΔVTP	VSS = 0V, IDD = 10μA	1, 4	+25°C	-	±1	V
Functional	F	VDD = 18V, VIN = VDD or GND	1	+25°C	VOH > VDD/2	VOL < VDD/2	V
		VDD = 3V, VIN = VDD or GND					
Propagation Delay Time	TPHL TPLH	VDD = 5V	1, 2, 3, 4	+25°C	-	1.35 x +25°C Limit	ns

- NOTES: 1. All voltages referenced to device GND. 2. CL = 50pF, RL = 200K, Input TR, TF < 20ns. 3. See Table 2 for +25°C limit. 4. Read and Record

TABLE 5. BURN-IN AND LIFE TEST DELTA PARAMETERS +25°C

PARAMETER	SYMBOL	DELTA LIMIT
Supply Current - MSI-1	IDD	± 0.2μA
Output Current (Sink)	IOL5	± 20% x Pre-Test Reading
Output Current (Source)	IOH5A	± 20% x Pre-Test Reading

**TABLE 6. APPLICABLE SUBGROUPS**

CONFORMANCE GROUP		MIL-STD-883 METHOD	GROUP A SUBGROUPS	READ AND RECORD
Initial Test (Pre Burn-In)		100% 5004	1, 7, 9	IDD, IOL5, IOH5A
Interim Test 1 (Post Burn-In)		100% 5004	1, 7, 9	IDD, IOL5, IOH5A
Interim Test 2 (Post Burn-In)		100% 5004	1, 7, 9	IDD, IOL5, IOH5A
PDA (Note 1)		100% 5004	1, 7, 9, Deltas	
Interim Test 3 (Post Burn-In)		100% 5004	1, 7, 9	IDD, IOL5, IOH5A
PDA (Note 1)		100% 5004	1, 7, 9, Deltas	
Final Test		100% 5004	2, 3, 8A, 8B, 10, 11	
Group A		Sample 5005	1, 2, 3, 7, 8A, 8B, 9, 10, 11	
Group B	Subgroup B-5	Sample 5005	1, 2, 3, 7, 8A, 8B, 9, 10, 11, Deltas	Subgroups 1, 2, 3, 9, 10, 11
	Subgroup B-6	Sample 5005	1, 7, 9	
Group D		Sample 5005	1, 2, 3, 8A, 8B, 9	Subgroups 1, 2, 3

NOTE: 1. 5% Parametric, 3% Functional; Cumulative for Static 1 and 2.

**TABLE 7. TOTAL DOSE IRRADIATION**

CONFORMANCE GROUPS	MIL-STD-883 METHOD	TEST		READ AND RECORD	
		PRE-IRRAD	POST-IRRAD	PRE-IRRAD	POST-IRRAD
Group E Subgroup 2	5005	1, 7, 9	Table 4	1, 9	Table 4

**TABLE 8. BURN-IN AND IRRADIATION TEST CONNECTIONS**

FUNCTION	OPEN	GROUND	VDD	9V ± -0.5V	OSCILLATOR	
					50kHz	25kHz
Static Burn-In 1 (Note 1)	3, 5, 7, 9, 11, 13	1, 2, 4, 6, 8, 10, 12, 14, 15	16			
Static Burn-In 2 (Note 1)	3, 5, 7, 9, 11, 13	8	1, 2, 4, 6, 10, 12, 14-16			
Dynamic Burn-In (Note 1)	-	1, 8, 15	16	3, 5, 7, 9, 11, 13	2, 4, 6, 10, 12, 14	
Irradiation (Note 2)	3, 5, 7, 9, 11, 13	8	1, 2, 4, 6, 10, 12, 14-16			

NOTES:

1. Each pin except VDD and GND will have a series resistor of 10K ± 5%, VDD = 18V ± 0.5V
2. Each pin except VDD and GND will have a series resistor of 47K ± 5%; Group E, Subgroup 2, sample size is 4 dice/wafer, 0 failures, VDD = 10V ± 0.5V

**Logic Diagram**

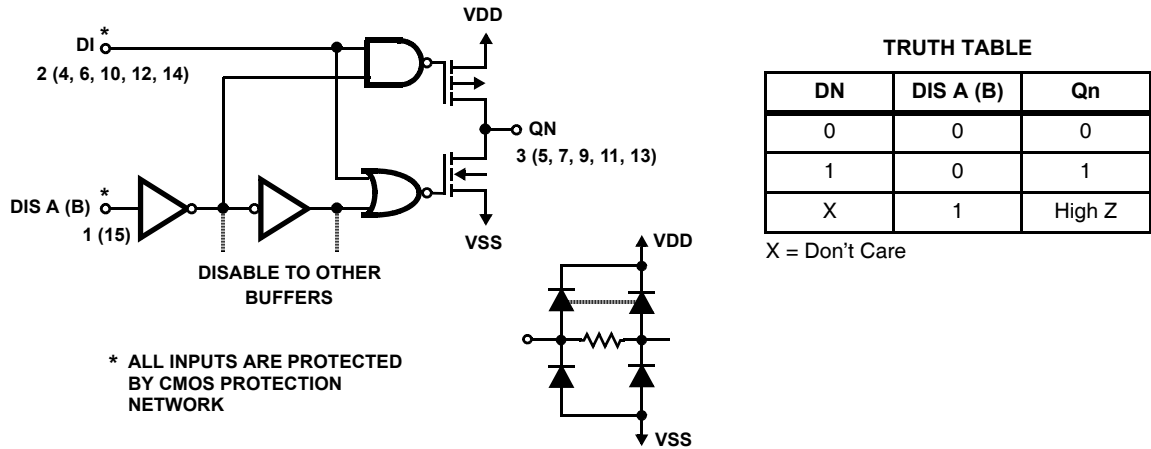

FIGURE 1. LOGIC DIAGRAM OF 1 TO 6 IDENTICAL BUFFERS

**Typical Performance Characteristics**

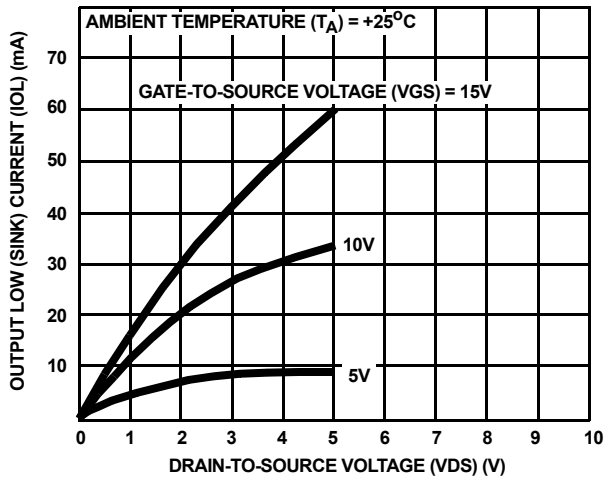

FIGURE 2. TYPICAL N-CHANNEL OUTPUT LOW (SINK) CURRENT CHARACTERISTICS

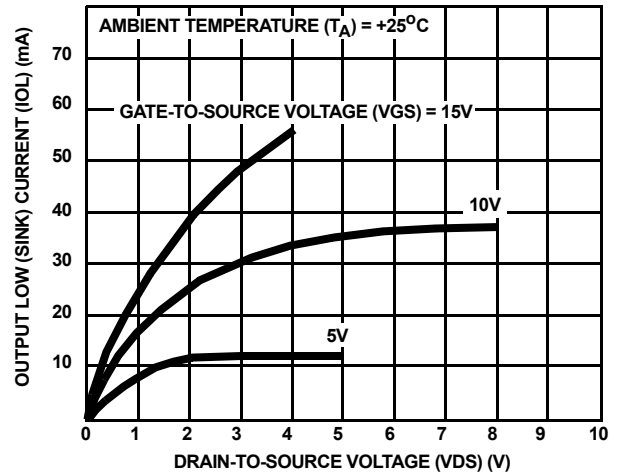

FIGURE 3. MINIMUM N-CHANNEL OUTPUT LOW (SINK) CURRENT CHARACTERISTICS

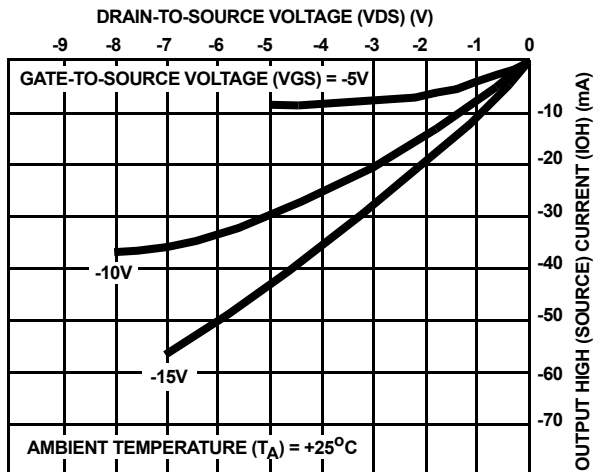

FIGURE 4. TYPICAL P-CHANNEL OUTPUT HIGH (SOURCE) CURRENT CHARACTERISTICS

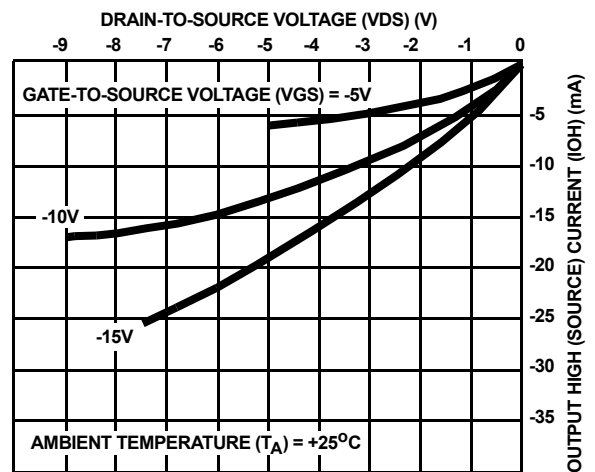

FIGURE 5. MINIMUM P-CHANNEL OUTPUT HIGH (SOURCE) CURRENT CHARACTERISTICS

**Typical Performance Characteristics** (Continued)

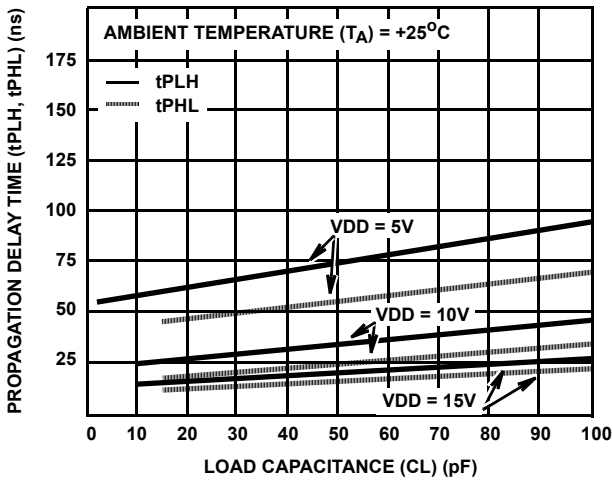

FIGURE 6. TYPICAL PROPAGATION DELAY TIME AS A FUNCTION OF LOAD CAPACITANCE

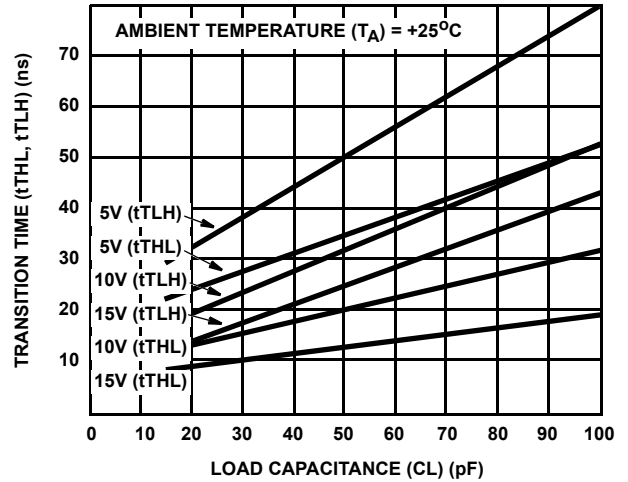

FIGURE 7. TYPICAL TRANSITION TIME AS A FUNCTION OF LOAD CAPACITANCE

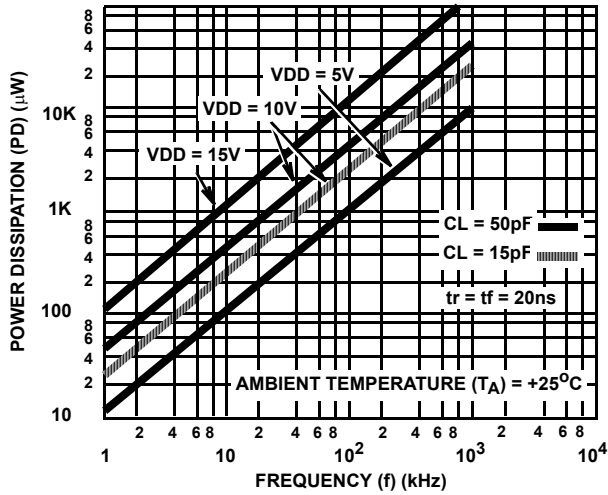
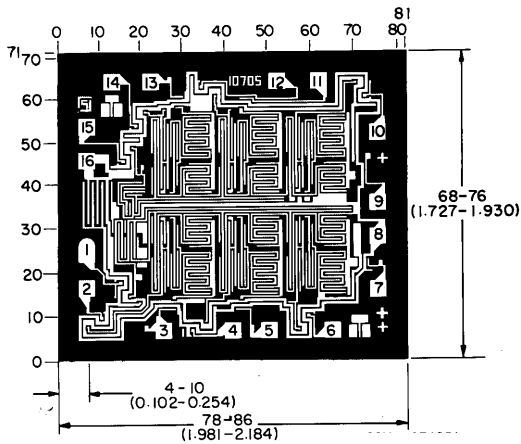

FIGURE 8. TYPICAL POWER DISSIPATION AS A FUNCTION OF FREQUENCY

**Chip Dimensions and Pad Layout**



Dimensions in parenthesis are in millimeters and are derived from the basic inch dimensions as indicated. Grid graduations are in mils ( $10^{-3}$  inch).

- METALLIZATION:** Thickness:  $11\text{k}\text{\AA}$  –  $14\text{k}\text{\AA}$ , AL.
- PASSIVATION:**  $10.4\text{k}\text{\AA}$  -  $15.6\text{k}\text{\AA}$ , Silane
- BOND PADS:** 0.004 inches X 0.004 inches MIN
- DIE THICKNESS:** 0.0198 inches - 0.0218 inches

© Copyright Intersil Americas LLC 1999. All Rights Reserved.

All trademarks and registered trademarks are the property of their respective owners.

For additional products, see [www.intersil.com/en/products.html](http://www.intersil.com/en/products.html)

Intersil products are manufactured, assembled and tested utilizing ISO9001 quality systems as noted in the quality certifications found at [www.intersil.com/en/support/qualandreliability.html](http://www.intersil.com/en/support/qualandreliability.html)

*Intersil products are sold by description only. Intersil may modify the circuit design and/or specifications of products at any time without notice, provided that such modification does not, in Intersil's sole judgment, affect the form, fit or function of the product. Accordingly, the reader is cautioned to verify that datasheets are current before placing orders. Information furnished by Intersil is believed to be accurate and reliable. However, no responsibility is assumed by Intersil or its subsidiaries for its use; nor for any infringements of patents or other rights of third parties which may result from its use. No license is granted by implication or otherwise under any patent or patent rights of Intersil or its subsidiaries.*

For information regarding Intersil Corporation and its products, see [www.intersil.com](http://www.intersil.com)