

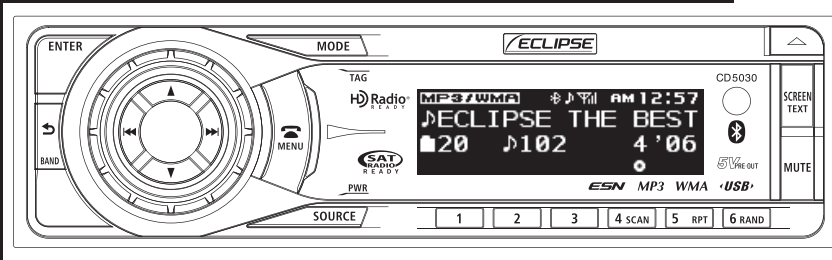

## Owner's Manual / Manual del propietario / Manuel de l'utilisateur



# CD5030

CD/USB Multi-Source Receiver / Built-in A2DP Bluetooth® wireless technology



WMA MP3



We appreciate your purchase of this receiver.  
Please read through this manual for correct operation.  
We suggest that after reading it you keep this manual  
in a safe place for future reference.

Tras adquirir este receptor rogamos lea atentamente su  
manual para una correcta utilización del equipo.  
Igualmente, guarde dicho manual en un lugar adecuado para poder  
recorrir a él en caso de futuras consultas.

Nous vous remercions d'avoir acheté ce récepteur.  
Veuillez lire ce manuel afin d'utiliser votre appareil correctement.  
Nous vous recommandons de conserver ce manuel  
dans un endroit sûr afin de pouvoir le consulter ultérieurement.

FUJITSU TEN

## For your safety in using the CD5030

Warnings and caution signs, illustrated below, are posted throughout this manual as well as on the CD5030. They show safe and correct ways to handle the product so as to prevent personal injury to you, others and to avoid property damage.

Before reading through the manual, take time to read through and learn the important information listed in this section.



**Warning**

This "Warning" sign indicates a situation in which incorrect handling or disregard of this sign might result in death or serious personal injury.



**Caution**

This "Caution" sign indicates a situation in which incorrect handling or disregard of this sign might result in personal injury or may result solely in damage to property.

Please read all materials such as manuals and warranties that have come with the product.

ECLIPSE will not be held liable for unsatisfactory product performance due to failure to follow these instructions.

### **WARNING**

- **Do not modify this system for use other than that specified herein. Also, do not deviate from the installation procedures described herein; ECLIPSE will not be held liable for damages including, but not limited to serious injury, death or property damage resulting from installations that enable unintended operation.**
- **This main unit requires 12 V DC and should only be installed in a vehicle with a 12 V negative ground electrical system. Any other installation may cause a fire or other severe damage to the main unit and the vehicle.**
- **Never install this main unit where it will interfere with safe operation of the vehicle. Never block the drivers' view. Do not install main unit where it may interfere with operation of the brakes, the steering or any safety equipment, including seat belts and air bags.**
- **Before drilling holes in a vehicle for installation, you must confirm the locations of pipes, tanks, electrical wiring, and other vehicle systems and components to ensure that there will be no interference or contact. In addition, you must also apply rust prevention and leak prevention measures at the drilling area. Otherwise, fire or electric shock could occur.**
- **When installing main unit do not remove or alter existing vehicle fasteners, including nuts, bolts, screws, clips, and fittings. Never detach, move or alter existing vehicle wiring, including electrical grounds and straps. Alteration of existing vehicle components may make vehicle unsafe to operate.**
- **Before installation, remove the negative (-) battery terminal to prevent shocks, electrical arcing, fires, and damage to vehicle wiring and the main unit you are installing.**
- **Secure wiring with tape or plastic ties so that wires do not interfere with vehicle operation, including brake pedal, gear shifter and steering. Position wires so that they will not be rubbed, abraded, or damaged by moving vehicle components, including power seats.**
- **To avoid main unit and vehicle damage, including fire, never supply power to the installed main unit in a way which will overload the capacity of an existing vehicle circuit. Never leave a power supply wire or connection uninsulated. Always install supplied fuses, circuit breakers, and relays.**

 **WARNING**

- Air bags are vital safety equipment. Never install the main unit in a way which will alter air bag wiring or interfere with air bag deployment. When you install the main unit, make sure that the air bags function properly in the event of an accident.
- When installation is complete, test all vehicle electrical systems for proper operation, including lights, horn, brake lights, and emergency flashers.
- For your protection, never use a power drill without safety glasses or goggles. Debris or broken drill bits may cause severe eye injuries, including blindness.
- Use electrical tape to insulate the ends of all wires, even if not used. Proper insulation prevents arcs, shocks and fires.
- Some equipment or devices require the use of batteries. Never install or place such type of equipment where young children can get access to batteries. If a battery is swallowed, seek medical attention immediately.
- When vehicle is moving, never take your eyes off the road to make adjustments to the main unit. You must pay attention to the road to avoid accidents. Do not let the operation or adjustment of the main unit distract you from proper vehicle operation.
- The driver should not look at the screen while driving. Accidents may result if you are not paying attention to the forward direction.
- Do not put foreign objects in the disc loading slot, the USB input terminal, or the iPod connector (if the optional cable is used). Fires or shocks may result.
- Do not disassemble or alter this main unit. Smoke, fires or shocks may result.
- Do not let water or foreign objects enter the internal parts of this main unit. Smoke, fires or shocks may result.
- Pay attention to where the remote control is left. Traffic accidents or problems with driving may result if the remote control makes its way under the foot pedals etc. when the vehicle is in motion.
- Do not use when abnormal operation occurs (the screen is not lit or no sound comes out). Accidents, fires or shocks may result.
- Always replace fuses with fuses of identical capacity and characteristics. Never use a higher capacity fuse than the original. Using incorrect fuse specifications may cause a fire or severe damage.
- If foreign objects or water enters the main unit, smoke comes out, or there is a strange odor, stop using it immediately, and contact your dealer. Accidents, fires, or shocks may result if you continue to use it in these conditions.
- The driver should not change CDs, connect or disconnect a USB memory or an iPod player while driving. As accidents may result if you are not looking ahead carefully. Stop the vehicle at a safe location and then handle such devices.
- Plastic bags and wrappings may cause suffocation and death. Keep away from babies and children. Never put bag over your head or mouth.

 **CAUTION**

- Wiring and installing this main unit requires expertise and experience. Professional installation is recommended. Consult with your dealer or a professional installer. Incorrect wiring may damage the main unit or interfere with safe vehicle operation.
- Use only the accessory parts as specified. Using other parts may cause damage to the main unit or cause parts to dislodge and/or detach unexpectedly.
- Do not install the main unit in places where it may get dew condensation on (around the air conditioning hose, etc.), come in contact with water, or in condition of high moisture, dust or oily smoke. If water, moisture, dust or oily smoke enters this main unit, smoke, fires or malfunctions may result.
- Avoid installing in places where it cannot be fastened securely or where there are strong vibrations. Also, if you installed the main unit with double-sided tape, first wipe away dirt and wax from the installation area. Otherwise, the main unit may come loose due to vibration while driving, causing problems for driving and resulting in traffic accidents or injuries.
- Do not install in places with direct sunlight or where it will be hit directly by hot air from the heater. This may increase the temperature of the interior of this main unit, resulting in fires and malfunctions.
- Do not obstruct the airflow of the heat sink or vents of this main unit. When the air flow of the heat sink or vents are obstructed, the interior overheats, and fires may result.
- Connect as specified in the installation manual. If not connected normally, fires or accidents may result.
- When installing in vehicles equipped with air bags, check the manufacturer's cautions regarding operation to ensure proper operation of the airbags.
- Install wiring in a manner that will not allow them to be pinched by moving parts, damaged by screws, or damaged by metal parts. Accidents, fires and shocks may result from disconnection and electrical shorts.
- Avoid hot surfaces when wiring main unit. High temperatures may damage wiring, causing shorts, arcing and fires.
- When changing the installation location for this main unit, please consult the dealer where you bought it for safety reasons. Expertise is necessary for removal and installation.
- Keep volume to a reasonable level so that you can hear sounds from outside the vehicle, including warning sounds, voices, and sirens. Failure to do so may cause an accident.
- Be careful that hands and fingers are not pinched when closing display. Injuries may result.
- Do not put your hands or fingers in the disc loading slot, the USB input terminal, or the iPod connector (if the optional cable is used). Injuries may result.
- Do not touch the heat dissipating part of the amp. Burns may result from the heat of this part.
- Do not recharge dry batteries. Dry batteries may rupture, resulting in injuries.
- Do not use batteries other than those specified. Also, do not mix old and new batteries. Injuries or pollution to the surroundings may result from battery ruptures and leakage.

 **CAUTION**

- When inserting batteries into the equipment or devices, be careful with the polarity (positive/negative), and insert them as indicated. If the battery polarities are incorrect, injuries and pollution to the surroundings may result from battery ruptures and leakage.
- Replace used batteries as soon as possible; they may leak and damage the remote control. Battery leakage can damage equipment or devices, or burn your skin or your eyes. Wash hands after handling.
- If alkaline solution from alkaline dry batteries makes contact with your skin or clothes, flush with clean water. If any of the solution gets in your eyes, also flush clean with water and then seek medical attention.
- When disposing of lithium dry cell batteries, affix insulating tape to the positive and negative terminals of the batteries, and after they are insulated, dispose of them according to the "Local municipal ordinances". Short circuiting, fire or ruptures may result from improper disposal if batteries come contact with other electrically conductive objects such as metal parts, etc.
- Do not short, disassemble or heat the batteries, or place them in fire or water. Fire and injuries may result from battery rupture and leakage.
- Store the remote control in a place away from direct sunlight, high temperatures, and high moisture levels. The outer case may change shape, and the batteries may rupture and leak.
- Do not use this main unit except for in-vehicle use. Shocks or injuries may result.
- Be careful of the position of the volume when turning the power source ON. Hearing damage may result if very loud noise is emitted when the power is turned ON.
- Do not operate under abnormal conditions such as when the sound is broken or distorted. Fires may result.
- This main unit uses invisible laser light. Do not disassemble or alter this main unit. If trouble occurs, contact the dealer where you bought the main unit. Altering this main unit may cause exposure to laser emissions (worsening eyesight), or result in accidents, fires or shocks.
- If the main unit is dropped or the cosmetics appear broken, turn off the power to the main unit and contact your dealer. If used in this condition, fires or shocks may result.

# *MEMO*

# Table of Contents

For your safety in using the CD5030.....	2
Operating precautions.....	14
Names of controls and parts .....	15
How to operate the CD/MP3/WMA player .....	21
How to operate the USB music file player.....	31
The Bluetooth audio function .....	35
How to operate the tuner.....	40
How to use the remote control .....	43
The Bluetooth hands-free function .....	45
ESN security operating procedure.....	58
How to operate the AUDIO CONTROL .....	62
How to operate the Sound Adjustment Mode .....	64
Making changes with Display Adjustment Mode.....	75
Making changes with Function Mode .....	79
How to operate the main unit with an optional CD changer connected.....	87
How to operate the tuner with an optional HD Radio tuner connected (U.S.A. only)...	89
How to operate the tuner with an optional XM satellite radio tuner connected (U.S.A./CANADA only)....	92
How to operate the tuner with an optional SIRIUS satellite radio tuner connected (U.S.A./CANADA only) ...	95
How to operate the main unit with the optional direct cable for iPod® connected .....	98
Others .....	102
If you have a question: .....	104
Specifications.....	109
How to contact customer service.....	111



# Table of Contents

<b><i>For your safety in using the CD5030</i></b> .....	<b>2</b>
<b><i>Operating precautions</i></b> .....	<b>14</b>
Notes on operation .....	14
<b><i>Names of controls and parts</i></b> .....	<b>15</b>
Turning the power on and off.....	17
Switching Audio Modes .....	17
Adjusting volume .....	17
Switching Rotary Modes.....	18
About a shortcut .....	18
Creating a shortcut.....	18
Using a shortcut .....	19
Switching screen .....	19
Detaching the front panel .....	20
Using the detachable panel.....	20
How to remove the detachable panel.....	20
How to attach the detachable panel.....	20
<b><i>How to operate the CD/MP3/WMA player</i></b> .....	<b>21</b>
About compact discs .....	21
About brand new CDs .....	22
About CD accessories.....	22
About borrowed CDs .....	22
Ejecting the disc .....	22
About irregularly-shaped CDs .....	23
About cleaning a CD.....	23
About MP3/WMA .....	23
What is MP3/WMA? .....	23
Playable MP3 file standards.....	24
Playable WMA file standards .....	24
ID3/WMA tag .....	24
Media .....	24
Format of discs.....	25
File names.....	26
Multi-sessions .....	26
Playing MP3/WMA .....	26
MP3/WMA playing time display.....	26
Display order of MP3/WMA file/folder names .....	26
Listening to a CD .....	27
TRACK (FILE) UP/DOWN .....	27
FOLDER UP/DOWN.....	28
FAST FORWARD/REWIND .....	28
SCAN*/REPEAT/RANDOM.....	28
FOLDER SCAN*/REPEAT/RANDOM .....	29



DISPLAYING TITLE .....	29
Ejecting the disc .....	30
<b><i>How to operate the USB music file player .....</i></b>	<b>31</b>
About playable USB memory standards .....	31
Playable MP3 file standards .....	31
Playable WMA file standards .....	32
Format of USB memory .....	32
How to operate the USB music file player .....	33
Listening to music files in USB memory .....	34
Disconnecting USB memory .....	34
<b><i>The Bluetooth audio function .....</i></b>	<b>35</b>
About the Bluetooth audio function .....	35
About the Bluetooth specifications .....	35
Supported Bluetooth specifications .....	35
Supported profile .....	35
What is Bluetooth? .....	36
Bluetooth audio setup .....	36
Displaying the BT Audio Set selection mode .....	36
Switching the Bluetooth audio mode on and off .....	36
Connecting the main unit and the portable device .....	37
Disconnecting the main unit and the portable device .....	38
Displaying device information for the main unit .....	38
Listening to music .....	39
Stopping the music .....	39
Pausing the music .....	39
Selecting the music you want to listen to .....	39
Fast forward/rewind .....	39
<b><i>How to operate the tuner .....</i></b>	<b>40</b>
Listening to the tuner .....	40
Tuning to a station .....	40
Operations during rotary mode .....	40
Automatically storing stations into memory. (The automatic preset mode: ASM) .....	41
Manually storing stations into memory .....	41
Preset station scan .....	41
Changing the reception sensitivity for automatic scanning .....	42
Changing the radio band location .....	42
<b><i>How to use the remote control .....</i></b>	<b>43</b>
Precautions in use of the remote control .....	43
Cleaning the remote control .....	43
Replacing the battery .....	44

<b>The Bluetooth hands-free function .....</b>	<b>45</b>
About the Bluetooth hands-free function .....	45
About the Bluetooth specifications .....	45
Supported Bluetooth specifications .....	45
Supported profile .....	45
What is Bluetooth? .....	46
Setting the Bluetooth hands-free function .....	46
Displaying the Phone Setting selection mode .....	46
Registering a cell phone .....	46
Delete a registered cell phone .....	48
Connecting a registered cell phone .....	49
Disconnecting a cell phone .....	49
Registering phone number in the phonebook .....	50
Setting Auto Answer .....	50
Setting the ring tone .....	50
Setting Auto Answer for registered cell phones .....	51
Displaying device information for the main unit .....	51
Enabling phone numbers to be input directly .....	51
Deleting data .....	51
Changing the passcode .....	53
Switching the speech output .....	54
Selecting the Bluetooth hands-free mode .....	54
Making a call .....	54
Making a call by dialing a phone number .....	54
Making a call using preset dial .....	55
Making a call using the incoming/outgoing call history .....	55
Making a call using the phonebook .....	56
Making a call from the cell phone .....	56
Receiving a call .....	56
Hanging up (refusing a call) .....	56
Adjusting the volume .....	56
Adjusting the ring tone volume .....	56
Adjusting the voice volume .....	57
Storing phone numbers in preset dial .....	57
<b>ESN security operating procedure .....</b>	<b>58</b>
About ESN .....	58
How to operate the ESN (Key CD) security .....	58
How to program the Key CD .....	58
How to cancel the Key CD .....	58
How to change the Key CD .....	59
How to resume normal operation (ESN security lock out) .....	59
What happens if an incorrect CD is inserted? .....	60
How to turn the security indicator on/off .....	60
How to read the Electronic Serial Number .....	61
<b>How to operate the AUDIO CONTROL .....</b>	<b>62</b>
Switching audio control modes .....	62

<b>How to operate the Sound Adjustment Mode .....</b>	<b>64</b>
About Sound Adjustment Mode .....	64
About parametric EQ .....	65
About time alignment .....	66
About crossover .....	66
Switching the sound adjustment mode .....	68
Parametric equalizer adjustment (PEQ) .....	68
Manually adjusting the equalizer mode .....	69
Selecting an equalizer mode from memory .....	69
Resetting the Equalizer mode .....	69
Automatically adjusting the equalizer mode (Auto EQ) .....	70
Measuring frequency characteristics .....	70
Changing the equalizer mode (Auto EQ) based on the measurement result .....	71
Time alignment adjustment (Time Alignment) .....	71
Manually adjusting Time Alignment .....	71
Automatically adjusting Time Alignment (Auto TA) .....	72
Position selector .....	73
Crossover adjustment (X-Over) .....	73
Multi-harmonizer settings (Harmonizer) .....	74
Non-fader settings (Non-F Setting) .....	74
Non-Fader Output settings (Output) .....	74
Non-fader phase settings (Phase) .....	74
 <b>Making changes with Display Adjustment Mode .....</b>	 <b>75</b>
Switching the Display Adjustment Mode .....	75
Switching the brightness (Bright) .....	75
Changing illumination color .....	76
Changing display type (DISP Type) .....	76
Changing Background (Background) .....	76
Changing spectrum analyzer (S/A) .....	76
Changing the scroll type (Scroll Type) .....	77
Importing display data (DISP Data) .....	77
 <b>Making changes with Function Mode .....</b>	 <b>79</b>
Switching the Function Mode .....	79
Setting the guide tone .....	79
Setting clock display (Clock ON/OFF) .....	79
Setting time (Clock Adjust) .....	80
Switching demonstration screen display (Demo) .....	80
Setting spectrum analyzer sensitivity (S/A Sensitivity) .....	81
Setting the steering remote function (U.S.A. only) .....	81
Automatic setup of steering remote functions (U.S.A. only) .....	82
Manual setup of steering remote functions (U.S.A. only) .....	83
Compatibility with various switches .....	85

<b><i>How to operate the main unit with an optional CD changer connected</i></b> .....	<b>87</b>
Listening to a CD .....	87
Advancing to the next track or returning to the beginning of the track being played ....	87
Operations during rotary mode .....	87
Fast forward/rewind .....	87
Playing the beginning of tracks (SCAN) .....	87
Repeating the same track (REPEAT) .....	88
Playing tracks in random order (RANDOM) .....	88
Skipping to the next or previous CD .....	88
Specifying a CD to play .....	88
<b><i>How to operate the tuner with an optional HD Radio tuner connected (U.S.A. only)</i></b> .....	<b>89</b>
About HD Radio .....	89
Switching between displays when receiving HD Radio .....	89
HD Radio reception settings .....	89
Tuning to a sub channel (SPS) .....	90
Storing tag information about the currently played track (Tagging) .....	91
<b><i>How to operate the tuner with an optional XM satellite radio tuner connected (U.S.A./CANADA only)</i></b> .....	<b>92</b>
About XM satellite radio .....	92
Selecting the radio mode .....	92
Selecting a channel .....	92
Operations during rotary mode .....	92
Category selection .....	93
Direct channel selection .....	93
Manually storing channels into memory .....	93
Preset channel scan .....	93
Switching displays when using the XM satellite radio .....	94
<b><i>How to operate the tuner with an optional SIRIUS satellite radio tuner connected (U.S.A./CANADA only)</i></b> .....	<b>95</b>
About SIRIUS satellite radio .....	95
Selecting the radio mode .....	95
Selecting a channel .....	95
Operations during rotary mode .....	95
Category selection .....	96
Direct channel selection .....	96
Manually storing channels into memory .....	96
Preset channel scan .....	96
Switching displays when using the SIRIUS satellite radio .....	97

<b><i>How to operate the main unit with the optional direct cable for iPod® connected</i></b> .....	<b>98</b>
Listening to iPod music files (If an iPod is not connected) .....	98
Listening to iPod music files (If an iPod is connected) .....	98
Switching the operation mode .....	99
Advancing to the next music file or returning to the beginning of the music file being played .....	99
Fast forward/rewind .....	99
Switching the list .....	99
Searching for a music file .....	99
Repeating the same music file (REPEAT).....	101
Playing music files in random order (SHUFFLE).....	101
Displaying text .....	101
<b><i>Others</i></b> .....	<b>102</b>
Connecting a portable audio player to the AUX jack .....	102
Switching the AUX mode on and off .....	102
Changing auxiliary input sensitivity .....	103
<b><i>If you have a question:</i></b> .....	<b>104</b>
Displayed information (for troubleshooting).....	104
When you think there is a malfunction.....	107
<b><i>Specifications</i></b> .....	<b>109</b>
<b><i>How to contact customer service</i></b> .....	<b>111</b>

\* For more information on the operation of E-iSERV (display data, steering remote), refer to the ECLIPSE Website given below and download the operation manual. (URL:<http://www.e-iserv.jp>)

# Operating precautions

<Your CD5030 will perform well over a long period of time through correct handling and care.>

## Notes on operation

---

- For your safety, play only at volume levels that allow outside sounds to be heard.



- Discs with the logo shown to the left can be played.
- You can play music CDs (CD-R/CD-RW) on this player. Be sure to use discs that have been properly processed. Depending on the editing format and software used, some discs may not play properly.

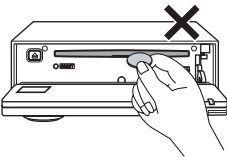

- Do not insert anything other than a CD into the main unit. Do not insert any foreign objects, such as coins or credit cards, into the disc slot.



- Avoid severe mechanical shock. When the player is subjected to severe vibration while traveling over a rough surface, playback may be intermittent. When a situation like this occurs, resume playback after returning to a smoother road.



- About dew condensation. In cold or rainy weather, just as the interior glass surface gets fogged, dew (water condensation) may also settle on the main unit. When this occurs, disc playback may become intermittent or impossible. Dehumidify the air in the vehicle for a while before resuming playback.

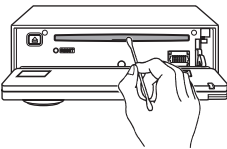

- Cleaning the disc slot. The disc slot tends to get dusty. Clean it occasionally to prevent accumulated dust from scratching the discs.

# Names of controls and parts

## Front view

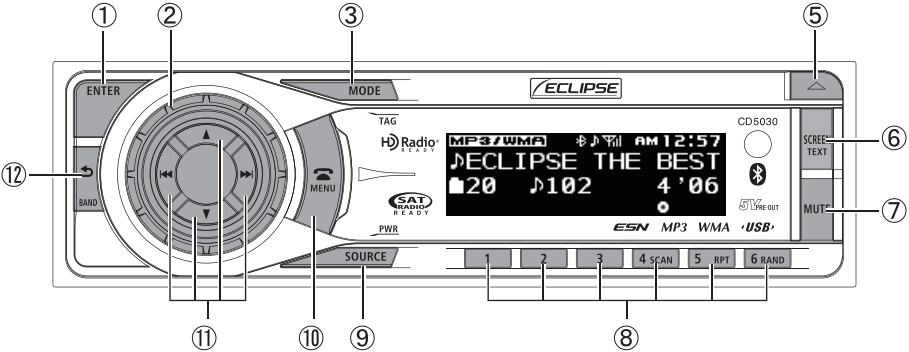

No.	Button	Name/Working
①		<b>[ENTER] button</b> Enters selected item.
②		<b>[VOL] knob</b> Adjusts volume.
③		<b>[MODE/TAG] button</b> Switches to the rotary mode. The settings can be switched.
④		<b>[▲ (EJECT)] button</b> Ejects a CD when this button is pressed.
⑤		<b>[▲ (OPEN)] button</b> Press this button to open the front panel.
⑥		<b>[SCREEN/TEXT] button</b> Switches the screen pattern. Switches the title display.

No.	Button	Name/Working
⑦		<b>[MUTE] button</b> Activates and deactivates mute.
⑧		<b>Buttons [1] to [6]</b> Selects radio preset channels and performs disc mode functions.
⑨		<b>[SOURCE/PWR] button</b> Switches audio source mode. Turn the power on or off.
⑩		<b>[☎/MENU] button</b> Switches to the TEL mode. Switches to the Menu Selection mode.
⑪		<b>[◀▶] [▲] [▼] buttons</b> Selects radio stations and CD tracks. Selects setting items.
⑫		<b>[↶/BAND] button</b> Returns to previous screen. Switches radio band.

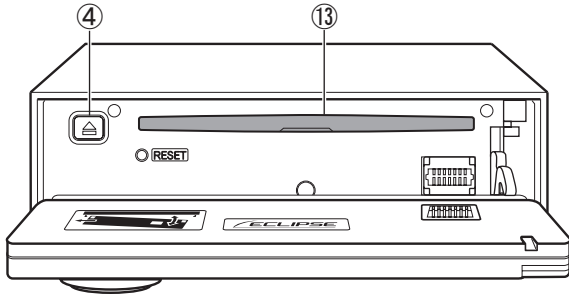

No.	Name/Working
13	<b>Disc slot</b> Inserts compact discs.

**CAUTION**

Never place an object or rest your hands or the like on the front panel.



## Turning the power on and off

When the power is turned on, the state used when the power was turned off such as CD and tuner playback is restored.

When the vehicle has no ACC position on the ignition switch, care is needed when turning off the main unit. Follow Step 2 or Step 3 when turning off the power.

### 1 Press the [SOURCE/PWR] button while the power is OFF.

The power will come ON.



### ATTENTION

When the main unit's power is turned on for the first time or if the battery terminals have been disconnected because of a reason such as vehicle maintenance and the power is then turned back on, the main unit will start up in FM1 mode. After this, the broadcast stations will be searched for automatically and stored in buttons [1] to [6].

### 2 Press the [SOURCE/PWR] button while the power is ON, for more than one second, until you hear a beep.

The power will go OFF and the main unit will be in Standby.

## Switching Audio Modes

### 1 Press the [SOURCE/PWR] button for less than one second.

Press the button to switch mode in the following sequence:

FM/AM → SIRIUS\*1 → XM\*1 → CD(MP3/WMA)\*2  
→ CDC\*1 → USB\*4, or iPod\*4 →

AUX\*3 → BT-Audio\*3 → FM/AM → ...

\*1: Cannot be selected if the corresponding device is not connected to the main unit.

\*2: Not displayed if no disc is inserted.

\*3: Cannot be selected if the AUX mode or the BT-Audio mode is not set to ON. For details, refer to "Switching the AUX mode on and off" on page 102 or refer to "Switching the Bluetooth audio mode on and off" on page 36.

\*4: Can be selected if the iPod or USB device is connected and the loaded media type is determined by the main unit.

## Adjusting volume

### 1 Turn the [VOL] knob right or left.

Turn to the right:  
Increases the volume.

Turn to the left:  
Decreases the volume.



### ATTENTION

Press the [MUTE] button for less than one second to mute the sound or restore it.



### CAUTION

Do not adjust the volume or other controls while driving the vehicle. Do so only while parked in a safe location.

## Switching Rotary Modes

The [VOL] knob can be switched to other functions. When the rotary mode is set to ON, you can switch from the volume adjustment function to the following functions by pressing the [VOL] knob.

Source	Function	Page
FM/AM	TUNE UP/DOWN	40
XM	Channel Up/Down	92
SIRIUS	Channel Up/Down	95
CDP/CDC	Track Up/Down	27
MP3/WMA	- File search - Folder search	27
USB	- File search - Folder search	27
iPod	Track search	99

For detailed information on the above functions, refer to the operation instructions for each related audio source.

1

**Press the [MODE/TAG] button while the main unit is set to any audio mode.**

Rotary mode will switch ON. When rotary mode is set to ON, the rotary indicator will be displayed as follows.

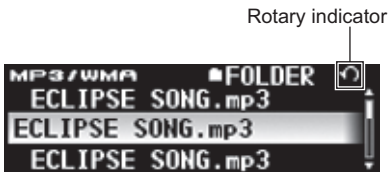

If the [MODE/TAG] button is pressed again, or if no operations are performed for more than 10 seconds, the rotary mode will be cancelled.

## About a shortcut

Create a shortcut for frequently-used functions so that they can be recalled with a single operation.

### Creating a shortcut

A shortcut can be created for one of the following MENU mode adjustment functions: sound adjustment mode, display adjustment mode, or function mode.

#### 1 Switch to the mode that you want to create a shortcut for.

Refer to the explanation for each adjustment mode for more information on switching them.

- Sound adjustment mode: Page 68
- Display adjustment mode: Page 75
- Function mode: Page 79

#### 2 Press the [☎/MENU] button for more than one second.

A shortcut will be created. If the [☎/MENU] button is not held down more than one second, the shortcut is not created and the main unit returns to the previous audio mode.

### ATTENTION

- If you attempt to create a shortcut for a hierarchy where this is not possible, the system will beep twice when [☎/MENU] button is pressed for more than one second. (The beep sounds only when the Guide Tone is set to ON.)
- Depending on the audio mode and the system setting, it may not be possible to operate the shortcut function. In this case, the system will beep twice when the [☎/MENU] button is pressed. (The beep sounds only when the Guide Tone is set to ON.)
- Only one shortcut function can be registered. If a shortcut has already been registered, its key will be deleted when a new shortcut is created.



## Using a shortcut







- 1 Press the [MENU] button for more than one second.  
The Menu Selection mode will be activated.
- 2 Press the [▲] or [▼] button to select "SHORTCUT".
- 3 Press the [ENTER] button.  
The mode for the shortcut created will be displayed.

## Switching screen

The screen's display pattern can be switched.

- 1 Press the [SCREEN/TEXT] for less than one second.  
When the button is pressed, the screen pattern changes display type in the following order.  
Display A → Display B → Display C → Spectrum analyzer → Motion picture → Display off → Display A ...

Pattern	Display
Display A 	Displays a screen showing the currently selected audio mode and the elapsed audio playback time. (The Display-A screen appears by default.)
Display B 	Displays a screen showing the currently selected audio mode, the elapsed audio playback time, and the text information.

Pattern	Display
Display C 	Displays a screen showing the currently selected audio mode, the elapsed audio playback time, and the clock time.
Spectrum analyzer type 1  Spectrum analyzer type 2 	Displays the spectrum analyzer set in the display adjustment mode (refer to page 76).
Motion picture 1  Motion picture 2 	Displays a screen showing the moving image set in the display adjustment mode (refer to page 76) and information such as elapsed CD playing time and current audio mode status.
Display off 	Displays a black screen.

## Detaching the front panel

### Using the detachable panel

The front panel of the main unit can be removed.

By removing this panel when you leave the vehicle, you can prevent the theft of the main unit.

### How to remove the detachable panel

- 1 Press the [**▲ (OPEN)**] button.

The front panel opens.

- 2 Detaching the front panel.

Hold the right-hand side of front panel, press it to the left, and pull it toward you to remove it.

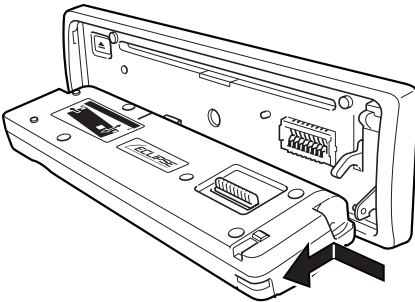

- 3 Put the front panel into the case.

Push to open the front panel case and put the front panel in it.

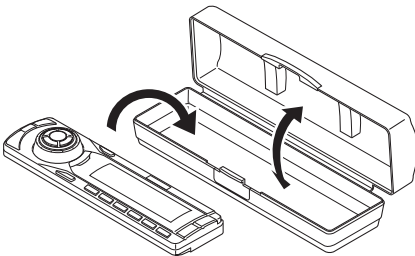

### How to attach the detachable panel

- 1 While holding the right end of the front panel, insert the left end of the front panel into the catch on the main unit.

- 2 By sliding the front panel to the left, press the right end of the front panel until it clicks into place.

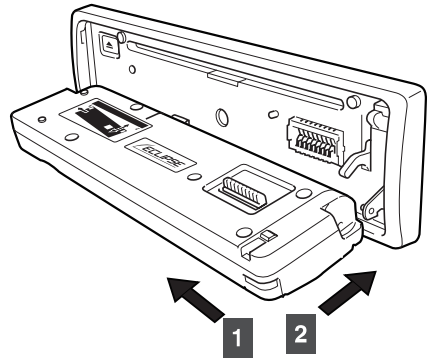

- 3 Manually close the front panel.

### **CAUTION**

- If you drop the detachable panel or subject it to impact, it may be damaged or malfunction.
- Do not attempt to detach or attach the detachable panel while driving since this could cause an accident.
- Store the detachable panel in a location free from humidity, dust, and water.
- Do not leave the detachable panel in locations that are likely to become hot, like the dashboard and surroundings.

# How to operate the CD/MP3/WMA player

## About compact discs

- The signal recorded on a compact disc is read by a laser beam, so nothing touches the disc surface. A scratch on the recorded surface or a badly warped disc may cause deteriorated sound quality or intermittent playback. Observe the following precautions to ensure high quality sound performance:

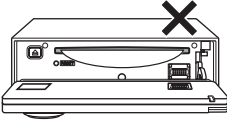

- Do not leave an ejected disc in the disc slot for very long; the disc may warp. Discs should be stored in their cases and kept away from high temperature and humidity.

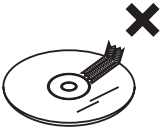

- Do not adhere a piece of paper or tape. Do not write on or scratch either side of a disc.



- Discs spin at a high speed inside the main unit. Keep cracked or warped discs out of the player to avoid damaging the main unit.



- Avoid touching the recorded surface when handling a disc; handle discs by their edges.

- This main unit can play a 12cm disc only. No 8cm disc can be played.

### CAUTION

Do not load multiple discs at a time.

## About brand new CDs

---

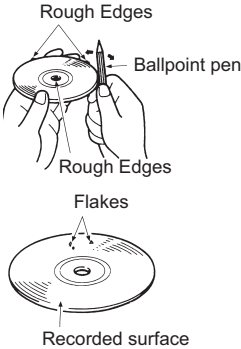

- You may notice that some brand new discs are rough around the center hole or outside edge. Remove the rough edges with the side of a ballpoint pen, etc. Rough edges may prevent proper loading in the main unit. Flakes from the rough edges may also stick to the recorded surface and interfere with playback.

## About CD accessories

---

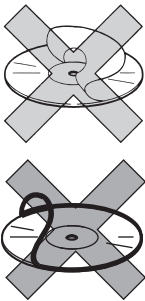

- Do not use accessories (stabilizers, protective seals, laser lens cleaners, etc.) sold for "improving sound performance" or "protecting CDs." The changes in CD thickness or outside dimensions made by these accessories may cause problems in the player.
- Please be sure NOT to attach any ring-shape protector (or other accessory) to your discs. Those protectors are commercially available and said to protect disc and to improve sound quality (and antivibration effect), but they can do more harm than good in regular uses. The most common problems are disc insertion, disc ejections, and won't play problems due to the protector ring that came off in the disc mechanism.

## About borrowed CDs

---

- Do not use a CD with glue or remnants of adhesive tape or labels. They may cause the CD to get stuck inside or damage the main unit.

## Ejecting the disc

---

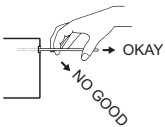

- When removing the ejected disc, pull it straight out along the slot. Removing the disc in a downward or upward angle may scratch the recorded surface of the disc.

## About irregularly-shaped CDs

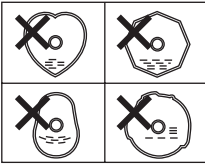

- Specially-shaped CDs, such as heart-shaped or octagonal CDs, cannot be played. Do not attempt to play them, even with an adapter connected, as they may damage the player.

## About cleaning a CD



- Use a commercially available compact disc cleaner to clean a CD, wiping gently from the center to the edge.

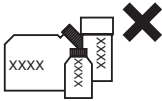

- Do not use benzine, thinner, LP record spray or other cleaners on CDs. They may damage a CD's finish.

## About MP3/WMA



### ATTENTION

The making of MP3/WMA files by recording from sources such as broadcasts, records, recordings, videos and live performances without permission from the copyright holder for uses other than personal enjoyment is prohibited.

## What is MP3/WMA?

MP3 (MPEG1 Audio Layer III) is a standard format for audio compression technology. By using MP3, a file can be compressed to one-tenth the size of the original.

WMA (Windows Media™ Audio) is format for audio compression technology. WMA files can be compressed to a size smaller than MP3 files.

This main unit has limitations on MP3/WMA file standards and recorded media and formats that can be used.

## ***Playable MP3 file standards***

---

- Supported standards:  
MPEG-1 Audio Layer III
- Supported sampling frequencies:  
44.1 kHz and 48 kHz
- Supported bit rate:  
64 to 320 (kbps)
  - \* Supports VBR.
  - \* Does not support free format.
- Supported channel modes:  
monaural, stereo, joint, dual

## ***Playable WMA file standards***

---

- Supported standards:  
WMA Ver.7  
WMA Ver.8  
WMA Ver.9  
WMA Ver.9.1  
WMA Ver.9.2
- Supported sampling frequencies:  
32, 44.1, 48 (kHz)
- Supported bit rate:  
48 to 320 (kbps)
  - \* Supports VBR.
  - \* Does not support WMA files with images (jackets) and WMA Pro, WMA Voice, or WMA Lossless files.
  - \* Does not support WMA files recorded at a frequency of 48 kHz with a bit rate of 96 Kbps.
- Supported channel modes:  
Monaural and stereo

## ***ID3/WMA tag***

---

MP3/WMA files have an "ID3 / WMA Tag" that allows input of information so that data such as song title and artist can be saved.

This main unit supports the ID3v.1.0, ID3v.1.1, ID3v.2.2, ID3v.2.3, ID3v.2.4 and WMA tags.

## ***Media***

---

Media capable of playing MP3/WMA includes CD-R and CD-RW discs. Compared to CD-ROM media commonly used for music discs, CD-R and CD-RW discs are fragile in high temperature/high humidity environments and one section of the CD-R and CD-RW may become incapable of playback. Fingerprints or scratches on the disc may prevent playback or cause skipping during playback. Sections of a CD-R and CD-RW may deteriorate if left inside a vehicle for long periods of time. It is also recommended that CD-R and CD-RW discs be kept in a light-blocking case because the discs are vulnerable to ultra-violet light.



## Format of discs

The format of discs to be used must be ISO9660 Level 1 or Level 2.

Control items for this standard are as follows:

- Maximum directory layers:  
8 layers
- Maximum number of characters for folder names/file names:  
32 (including "." and a 3-letter file extension)
- Allowable characters for folder names/file names:  
A~Z, 0~9, \_ (underscore)
- Number of files possible on a single disc:  
511

[Configuration example for CD supporting MP3/WMA]

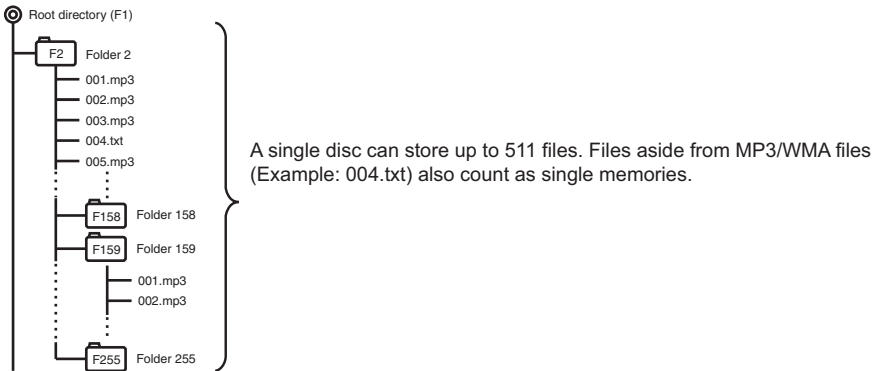

- Total number of folders possible on a single disc:  
255

## **File names**

---

Only files with the MP3/WMA file extension ".mp3" or ".wma" can be recognized as MP3/WMA and played. Be sure to save MP3 files with the ".mp3" file extension. Also, save WMA files with the ".wma" file extension. "MP" of the file extension can be either uppercase or lowercase letters.

### **CAUTION**

If the ".mp3" or ".wma" file extension is attached to a file other than an MP3/WMA file, that file will be mistakenly recognized by the main unit as an MP3/WMA file and played. This results in a loud noise being output, which can damage speakers. Do not save a non-MP3/WMA file with the "mp3" or "wma" extension.

## **Multi-sessions**

---

Multi-sessions are supported, and the playing of CD-R and CD-RW discs with MP3/WMA files added is possible. However, if files have been written onto a disc using "Track at once", close the session or perform the finalization process. Standardize the format so that it does not change with each session.

## **Playing MP3/WMA**

---

When a disc with recorded MP3/WMA files is inserted, the main unit first checks all the files on the disc. No sound is output while the main unit is checking the files on the disc. It is recommended that the disc be recorded without files other than MP3/WMA files and without unnecessary folders in order to speed up the checking of disc files by the main unit.

## **MP3/WMA playing time display**

---

It is possible that playing time will not be correct, depending on the writing condition of the MP3/WMA file.

\* It is possible that playing time will not be correct when VBR Fast Up/Down is operated.

## **Display order of MP3/WMA file/folder names**

---

Names of MP3/WMA folders and files within the same level are displayed in the following order.

- 1.MP3/WMA folders displayed first, by ascending order of numbers, letters.
- 2.Files displayed next, by ascending order of numbers, letters.

## Listening to a CD

### 1 Press the [▲ (OPEN)] button.

The front panel opens.

If a CD is already inserted into the slot, eject it by pressing the [▲ (EJECT)] button.

### 2 Insert a CD into the disc slot, label side up.

Close the front panel by your hand, and the CD will start to play automatically.



### ATTENTION

- Playback may be intermittent when there is a scratch on a CD or when the recorded side is dirty.
- If a CD has already been loaded, press the [SOURCE/PWR] button for less than one second to switch to the CD mode. (For details, refer to "Switching Audio Modes" on page 17.)



### CAUTION

When a CD is being loaded, do not push the front panel. This could cause your injury or a damage to the disc or front panel.

### NOTE

- When music data recorded in the normal way (CD-DA) is present on the same disc with MP3/WMA music files, the normally recorded music data will be played. To listen to the MP3/WMA music files, press [MODE/TAG] button for more than one second.
- MP3/WMA files which are not supported cannot be played. In this case, "NO SUPPORT" appears.
- The optional CD changer cannot be used to play MP3/WMA files.

## TRACK (FILE) UP/DOWN

### CD, MP3/WMA

### 1 Press the [⏪] or [⏩] button.

[⏩]:

Advances to the next track.

[⏪]:

Returns to the beginning of the track being played.

### CD (Rotary mode)

### 1 Press the [MODE/TAG] button for less than one second to display the file list.

### 2 Turn the [VOL] knob.

To the right:

Advances to the next track.

To the left:

Returns to the beginning of the track being played.

### MP3/WMA (Rotary mode)

### 1 Press the [MODE/TAG] button for less than one second to display the file list.

The display list changes in the order shown below each time you press the button.

File list → Folder list → File list → ...

### 2 Turn the [VOL] knob to select a file.

To the right:

Advances to the next track.

To the left:

Previews previous tracks.

**3** Press the [ENTER] button.



**ATTENTION**

For details, refer to the Rotary Mode operation on page 18.

**FOLDER UP/DOWN**

**MP3/WMA**

**1** Press the [▲] or [▼] button.

[▲]:

Selects the next folder.

[▼]:

Selects the previous folder.

Press the [↔/BAND] button to go to the next higher layer. (A configuration example of MP3/WMA CDs is given in see page 25.)

**MP3/WMA (Rotary mode)**

**1** Press the [MODE/TAG] button for less than 1 second to display the folder list.

The display list changes in the order shown below each time you press the button.

File list → Folder list → File list → ...

**2** Turn the [VOL] knob to select a folder.

To the right:

Advances to the next folder.

To the left:

Previews previous folders.

**3** Press the [ENTER] button.

**FAST FORWARD/REWIND**

**CD, MP3/WMA**

**1** Hold down the [⏮] or [⏭] button.

[⏭]:

Fast forwards.

[⏮]:

Rewinds.

**SCAN\*/REPEAT/RANDOM**

**CD**

**1** Press the [5 RPT] or [6 RAND] button.

[5 RPT]:

Repeating the same track. Press the button again to cancel this operation.

[6 RAND]:

Change the order of the tracks, and play them in random order. Press the button again to cancel this operation.

**MP3/WMA**

**1** Press the [4 SCAN]\*, [5 RPT], or [6 RAND] button.

[4 SCAN]\* :

The main unit will play the first ten seconds of all files located in the same layer as the folder currently being played. Press the button again to cancel this operation.

\*:Can only be used when a USB memory device is connected.

[5 RPT]:

Repeating the same file. Press the button again to cancel this operation.

[6 RAND]:

The main unit will randomly play all files located in the same layer as the folder currently being played. Press the button again to cancel this operation.

**ATTENTION**

- During random playback, press the [5 RPT] button to repeat the track (file) being played. Press the [5 RPT] button again to cancel repeat play (and return to random play).
- Occasionally the same track will play two or more times. This is a normal operation and is not a sign of a problem.
- "REPEAT" or "RANDOM" will appear on the display when these functions are active.
- When a USB memory device is connected, and the scan function is active, "SCAN" will appear on the display.

**FOLDER SCAN\*/REPEAT/  
RANDOM****MP3/WMA**

**1** Press the [4 SCAN]\*, [5 RPT], or [6 RAND] button for at least one second.

[4 SCAN]\* :

The main unit will play the first ten seconds of the first song in each folder. Press the button again to cancel this operation.

\*: Can only be used when a USB memory device is connected.

[5 RPT]:

The tracks in the same layer as the folder being played are played repeatedly. Press the button again to cancel this operation.

[6 RAND]:

The files in all folders are played randomly. Press the button again to cancel this operation.

**DISPLAYING TITLE**

*(TEXT supported CD's)*

**1** Press the [SCREEN/TEXT] button for more than one second.

CD text will be scrolled on the display.

## MP3/WMA

### 1 Press the [SCREEN/TEXT] button for more than one second.

Each time the button is pressed, the text will be displayed in the following order.

Folder name/File name \* → Tag

\*: A maximum of 14 characters can be displayed in the display area. The remaining characters can be displayed by scrolling. The folder name is displayed first. The file name can then be displayed by scrolling. After the file name has been displayed, the display will be fixed.

### ATTENTION

- CD text cannot be displayed using CD changers (sold separately).
- If the CD came with a logo shown below, it is recorded with a disc title and track titles. These information will be displayed during playback.



- CD text, Folder name/file name or tag recorded with characters other than alphanumeric and symbols cannot be displayed.

## Ejecting the disc

### 1 Press the [▲ (OPEN)] button.

The front panel opens.

### 2 Press the [▲ (EJECT)] button.

The disc will be ejected.

### 3 Manually close the front panel.

### CAUTION

Do not drive with the front panel open. The panel may cause unexpected personal injury during a panic stop, or the like.

# How to operate the USB music file player

## About playable USB memory standards

---

- Supported File System:  
FAT 12/16/32
- Playable Audio Format:  
MP3/WMA
- Max.Current:  
500 mA
- Compatibility:  
USB1.1/2.0 (Full speed)
- Correspondence:  
USB mass storage class

## *Playable MP3 file standards*

---

- Supported standards:  
MPEG-1  
MPEG-2  
Audio Layer III
- Supported sampling frequencies:  
MPEG-1: 32, 44.1, 48 (kHz)  
MPEG-2: 16, 22.05, 24 (kHz)
- Supported bit rate:  
MPEG-1: 32, 40, 48, 56, 64, 80, 96, 112, 128, 160, 192, 224, 256, 320 (kbps)  
MPEG-2: 8, 16, 24, 32, 40, 48, 56, 64, 80, 96, 112, 128, 144,160 (kbps)  
\* Supports VBR. (8 to 320 Kbps)  
\* Does not support free format.
- Supported channel modes:  
Stereo, Joint, Dual, Monaural

## Playable WMA file standards

---

- Supported standards:
  - WMA Ver.7
  - WMA Ver.8
  - WMA Ver.9
  - WMA Ver.9.1
  - WMA Ver.9.2
- Supported sampling frequencies:
  - 32, 44.1, 48 (kHz)
- Supported bit rate:
  - 48 to 320 (kbps)
  - \* Supports VBR. (48 to 384 kbps)
  - \* Does not play DRM.
  - \* Does not support WMA files with images (jackets) and WMA Pro, WMA Voice, and WMA Loss-less files.
- Supported channel modes:
  - Stereo, Monaural

## Format of USB memory

---

The USB memory format must be ISO9660 Level 1 or Level 2. Standards are as follows:

- Maximum directory layers:
  - 8 layers
- Maximum number of characters for folder names/file names:
  - 32 (including "." and a 3-letter file extension)
- Allowable characters for folder names/file names:
  - A~Z, 0~9, \_ (underscore)
- Number of files possible on a single USB memory:
  - 3000

[Configuration example for USB memory supporting MP3/WMA]

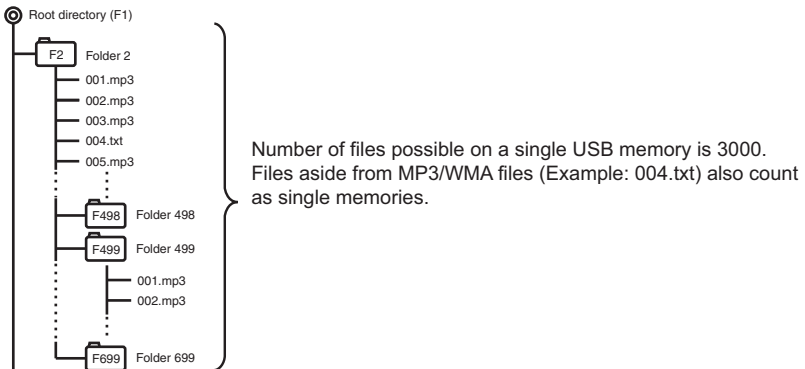

- Maximum total number of folders possible on a single USB memory:
  - 699



## How to operate the USB music file player

Plug a digital audio player or a USB memory (having a USB terminal) into the USB connector and set the main unit to the USB mode, and you can listen to a music file of the audio player or USB memory.

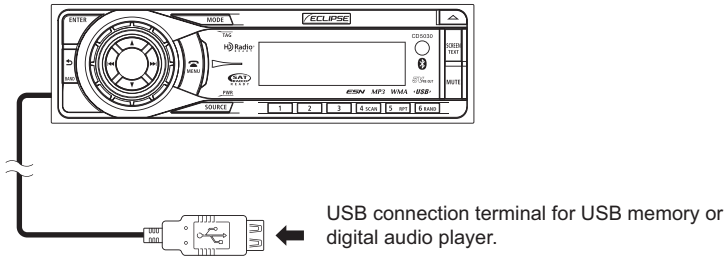

## Listening to music files in USB memory

---

**1** Connect the USB memory to the USB connector.

**2** Hold down the [SOURCE/PWR] button for less than 1 second until the USB mode is shown.

For details, refer to "Switching Audio Modes" on page 17.

**3** Operate the USB music file player.

The procedure for playing music is the same as that are used to play CDs. For details, see "How to operate the CD/MP3/WMA player" (page 27 - 29).



### ATTENTION

---

If the USB mode is changed to another mode and then returned to the USB mode, the player will return to the previous file played.

---



### CAUTION

- Do not disconnect the USB memory or turn the ignition key to ACC OFF position while accessing the USB memory. Doing so may corrupt the data.
- Depending on the type connected, the USB memory may not work in some cases.
- The USB memory does not support multi-partition. Also, it does not support USB hub.
- It is highly recommended to back up your data in case of accidental deletion.
- Install and use the USB device in a place that provides safe operation of the vehicle.
- The music files under the copyright protection cannot be played.
- When connecting a digital audio player to the USB connector, additional USB adaptors may be required.

## Disconnecting USB memory

---

**1** Disconnect the USB memory parallel to the USB connector.



### ATTENTION

---

Do not disconnect the USB memory during playback.

---



### CAUTION

Do not apply excessive force when removing the USB memory. Doing so may damage the USB connector and/or the USB memory.

# The Bluetooth audio function

## About the Bluetooth audio function

The use of Bluetooth wireless communication technology enables a Bluetooth-compatible portable audio player (hereafter called "a portable device") to be used as a source for the main unit.

Once the portable device is connected to the main unit, it is possible to listen to music without directly operating the portable device.

Because the connection between the portable device and the main unit is wireless, cable connection is not needed.

- Before using a Bluetooth-compatible portable device (including a cell phone) with the main unit, be sure to complete the "Bluetooth audio set up". (For details, see page 36.)
- When the portable device has been connected to the main unit, the Bluetooth connection indicators will be displayed.

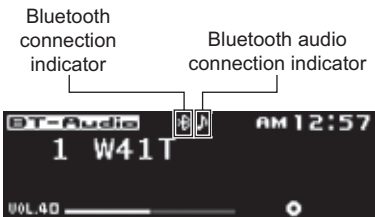

- Noise may be experienced when using the Bluetooth cell phone and Bluetooth audio.
- Depending on the version of Bluetooth, some cell phones may not be able to communicate with the main unit.
- Depending on the surrounding environment, the connection may become unstable, and the Bluetooth audio function may not be able to be operated from the main unit.

## ATTENTION

- If the portable device is used with other wireless devices, it may have a negative effect on the communication capabilities of both.
- The Bluetooth communication connection may cause the batteries in the portable device to lose their charge quickly.

## About the Bluetooth specifications

The Bluetooth-compatible portable device to be connected to the main unit must be compatible with the following specifications. (However, depending on the models of the portable device, some of the functions may be limited.)

### Supported Bluetooth specifications

Bluetooth Specification Ver.2.0

### Supported profile

- A2DP (Advanced Audio Distribution Profile) Version 1.0 :  
Profile for transmission of high quality sound
- AVRCP (Audio/Video Remote Control Profile) Version 1.0 :  
Profile for control of AV equipment by remote-control

## What is Bluetooth?

Bluetooth is a form of short-range wireless communication technology used to connect cell phones and personal computers.

This technology enables hands-free calling and data transmission between Bluetooth-compatible devices.



Bluetooth is a registered trademark of Bluetooth SIG, Inc.

### **WARNING**

For safety reasons, the driver must not operate the portable device while driving. Stop the vehicle in a safe location before operating the device.

### **CAUTION**

- Do not leave the portable device inside a vehicle. (The temperature inside a vehicle may increase dramatically when it is exposed to extreme heat from the sun.)
- Do not use the portable device in a location close to the main unit. If they are too close together, the sound quality and the connection may be adversely effected.

## Bluetooth audio setup

A variety of functions available when using the portable device can be set from the BT Audio Set mode.

- BT Audio setting:  
Bluetooth audio mode on and off.
- Connection setting:  
Main unit and portable device connectivity.
- Disconnection setting:  
Disconnects the main unit and the portable device.

- Device INFO display:  
Displays device information for the main unit.

## Displaying the BT Audio Set selection mode

- 1 Press the [PHONE/MENU] button for more than one second.**

The MENU selection mode is displayed.

- 2 Select the "FUNC" by pressing the [▲] or [▼] button.**

- 3 Press the [ENTER] button.**

- 4 Select "BT Audio Setting" by pressing the [▲] or [▼] button.**

- 5 Press the [ENTER] button.**

The BT Audio Setting selection mode is activated.

## Switching the Bluetooth audio mode on and off

The Bluetooth audio function can be selected while in the audio mode.

- 1 Press the [PHONE/MENU] button for more than one second.**

The MENU selection mode is displayed.

- 2 Select the "FUNC" by pressing the [▲] or [▼] button.**

- 3 Press the [ENTER] button.**

- 4 Select "BT Audio ON/OFF" by pressing the [▲] or [▼] button.**

- 5 Press the [ENTER] button.**

## 6 Select "ON" or "OFF" by pressing the [▲] or [▼] button.

ON:

Enables BT-Audio

OFF:

Disables BT-Audio

## 7 Press the [↔/BAND] button.

The portable device is set as a Bluetooth audio source.

### ATTENTION

- The Bluetooth audio (BT-Audio) function can only be selected in the audio mode when the BT Audio Set selection mode is set to ON.
- The default setting for the Bluetooth audio mode is OFF (BT-Audio selection is disabled).

## ***Connecting the main unit and the portable device***

### 1 In the BT Audio Setting selection mode, select "Connect" by pressing the [▲] or [▼] button.

### 2 Press the [ENTER] button.

The "Waiting" message appears on the display.

### ATTENTION

Press the [↔/BAND] button to change the portable device to be connected. The BT Audio Setting selection mode will be activated again.

### 3 Input the passcode using the portable device.



The default passcode is 1234.

### ATTENTION

- For details on how to operate the portable device, read its instruction manual.
- Be sure to perform the connection of the portable device only while the "Waiting" message is on the display.

### 4 When the connection has been completed, the "COMPLETED" message appears on the display.

The portable device is connected to the main unit.

( and  appear on the display.)

If the connection has not been successfully completed, the "FAILED" message appears on the display.

### ATTENTION

- If the portable device is still connected, disconnect it.
- If the connection has failed and the "FAILED" message appears on the display, connect the portable device again in the BT Audio Setting selection procedure of Step 1.
- The passcode is a password used when connecting the portable device to the main unit.
- When the audio of the cell phone is connected, hands-free can be connected at the same time for some devices. If you want to be able to use the hands-free function, perform the hands-free connection procedure again.

## **Disconnecting the main unit and the portable device**

---

**1** In the BT Audio Setting selection mode, select "Disconnect" by pressing the [▲] or [▼] button.

**2** Press the [ENTER] button.

The "Disconnect ?" message appears on the display.

**3** Press the [ENTER] button.



### **ATTENTION**



---

If you do not want to cancel the connection, press [↔/BAND] button. The BT Audio Setting selection mode will be activated again.

---

**4** When the disconnection has been completed, the "COMPLETED" message appears on the display.

The main unit is disconnected from the portable device.

(The  and  are cleared from the display. However,  will not disappear while Bluetooth hands-free is connected.)

## **Displaying device information for the main unit**

---

The name of the device (main unit), the passcode and the BD ADD (device address) can be displayed.

**1** In the BT Audio Setting selection mode, select "Device INFO" by pressing the [▲] or [▼] button.

**2** Press the [ENTER] button.

The name of the device and the passcode are displayed.



### **ATTENTION**

---

Each time the [SCREEN/TEXT] button is pressed, the display changes in the following way.

Device name / Passcode ↔ BD ADD (Device address)

---

**3** Press the [↔/BAND] button.

The BT Audio Setting selection mode will be activated again.

## Listening to music

---

1

Hold down the [SOURCE/PWR] button for less than 1 second until the Bluetooth Audio mode is shown.

For details, refer to "Switching Audio Modes" on page 17.

2

Press button [1].

The connected Bluetooth-compatible portable device starts to play music.



### ATTENTION

---

- If the portable device is not connected to the main unit, its play function is disabled.
  - If audio play does not start even when you press [1] button on the main unit, press the Play button on the portable device.
- 

## Stopping the music

---

1

Press the [SOURCE/PWR] button for less than one second to switch to another audio mode.

For details, refer to "Switching Audio Modes" on page 17.



### ATTENTION

---

The portable device may continue to play music even if it is switched to another audio mode.

---

## Pausing the music

---

1

Press button [1].

The music being played is paused.



### ATTENTION

---

Press the [1] button to start audio play again.

---

## Selecting the music you want to listen to

---

1

Press the [◀◀] or [▶▶] button.

[▶▶]:

Advances to the next track.

[◀◀]:

Returns to the beginning of the track being played.



### ATTENTION

---

Press the [◀◀] button repeatedly to return to previous tracks.

---

## Fast forward/rewind

---

1

Hold down the [◀◀] or [▶▶] button.

[▶▶]:

Fast forwards.

[◀◀]:

Fast rewinds.



### ATTENTION

---

The fast forwarding or rewinding continues until you release the [◀◀] or [▶▶] button.

---

# How to operate the tuner



## ATTENTION

If stations have been stored in memory, pressing a button from [1] to [6] will enable you to select a station. (Refer to "Manually storing stations into memory" on page 41.)

## Listening to the tuner

1

**Hold down the [SOURCE/PWR] button for less than 1 second until the FM/AM mode is shown.**

For details, refer to "Switching Audio Modes" on page 17.

## Tuning to a station

There are both automatic and manual methods (one of each) for storing stations in memory. The main unit will accept up to 24 stations in memory. There are 6 stations for AM and 18 stations for FM (6 each for FM1, FM2 and FM3) (initial settings).

1

**Press the [BAND] button briefly (for less than one second) to switch to the desired FM or AM band.**

Radio bands will switch from FM1 → FM2 → FM3 → AM in order each time the button is pressed.

2

**Tune to a station frequency by pressing the [F1] or [F2] button.**

[F1]:

Tunes to higher frequencies.

[F2]:

Tunes to lower frequencies.

3

**If you hold down the [F1] or [F2] button for a little longer time, the device starts to search for stations automatically.**

[F1]:

Select higher frequency stations.

[F2]:

Selects lower frequency stations.



## ATTENTION

At times, it may be difficult to maintain optimum reception because the antenna attached to your vehicle is constantly in motion (relative to the broadcast antenna), encountering continuous variation in the strength of the radio signals received. Other factors affecting reception include interference from natural obstacles, buildings, etc.

If the optional HD Radio tuner unit is connected, digital broadcasts can be received. (U.S.A. only)

## Operations during rotary mode

For operations in rotary mode, see page 18.



## Automatically storing stations into memory. (The automatic preset mode: ASM)

- 1 Hold down the [▲] button (for more than one second) until the beep sounds.

The automatic preset mode starts.

"ASM ON" will appear on the display, and stations are automatically entered in memory under buttons [1] to [6].

These buttons are called the preset buttons.



### ATTENTION

- Pressing the preset buttons ([1] to [6]) allows you to make one-touch station selections. The frequency of the selected station is shown on the display.
- When a new station is set in memory, the station previously set in memory will be deleted.
- If there are fewer than six receivable stations, the stations set in the remaining buttons will be retained.



### CAUTION

If the vehicle's battery is disconnected (for repairs to the vehicle or for removing the main unit), all stations in memory will be lost. In such a case, store stations in the memory again.

## Manually storing stations into memory

Store a station to a preset button.

- 1 Tune to a station frequency you wish to store by pressing the [◀◀] or [▶▶] button.

- 2 Select any button, from [1] to [6], and press it for more than two seconds.

The selected station is stored in the preset button.

Repeat the above procedure to store additional stations one at a time in buttons [1] to [6], and store them in memory.



### CAUTION

If the vehicle's battery is disconnected (for repairs to the vehicle or for removing the main unit), all stations in memory will be lost. In such a case, store stations in memory again.

## Preset station scan

This function enables reception of all the stations in the preset buttons for five seconds each.

- 1 Hold down the [▼] button for more than 1 second.

"P SCAN" will appear on the display, and stations stored under preset buttons [1] through [6] will be played for five seconds each.

- 2 When your desired station is displayed, press the [▼] button again.

The main unit will stay tuned to the desired station.

## Changing the reception sensitivity for automatic scanning

The main unit lets you select the reception sensitivity to be used for automatic scanning of stations. You can select either LOCAL or DX signal receiving sensitivity.

LOCAL mode	During automatic scanning, the reception sensitivity switches automatically to one of two levels. Initially the reception sensitivity is set to the low level so that only stations with strong signals are received. If no stations could be received, the reception sensitivity is increased so that stations with weaker signals can also be received.
DX Mode	Because the reception sensitivity for automatic scanning is set to the high level from the start, even stations with weaker signals can be received. (Signal crossover may result in some stations being hard to hear.)

### ATTENTION

When an optional HD Radio tuner unit is connected, the sensitivity is set to the LOCAL mode. The DX Mode is unavailable. (U.S.A. only)

**1** Check that the power of the main unit is in the standby state (with the power turned off).

**2** Press and hold button [1] and the [📶/MENU] button simultaneously for more than three seconds.

The mode switches between LOCAL mode and DX mode each time the buttons are pressed.

## Changing the radio band location

The location for the radio bands used between the North American region and the Asia/Australia/Latin region can be switched. The default setting is USA (North America).

### ATTENTION

When an optional HD Radio tuner unit is connected, radio band location is set to USA. Other radio band locations are unavailable. (U.S.A. only)

**1** Check that the power of the main unit is in the standby state (with the power turned off).

**2** Press and hold button [3] and the [📶/MENU] button simultaneously for more than three seconds.

The radio band switches in the order shown below each time the buttons are pressed.

USA → ASIA → AUS → LATIN → USA ...

When the power is turned on, stations will be searched for automatically, and stored in buttons [1] to [6].

# How to use the remote control

## Precautions in use of the remote control

- Be careful when handling the control, especially because it is small and light. Dropping or striking it hard may damage it, wear out the battery or cause a malfunction.
- Keep the remote control free of moisture, dust and water. Do not subject it to shock.
- Do not place the remote control unit in places where it could be exposed to high temperatures, such as on the dashboard or near a heater vent. Allowing the remote control unit to overheat may warp its case or cause other problems.
- Do not operate the remote control unit while driving because doing so could cause an accident.
- When using the remote control, point it toward the remote control light receptor.
- The light receptor may not operate correctly if it is exposed to bright light such as direct sunlight.
- Remove the batteries from the remote control unit whenever it is not to be used for a long time.







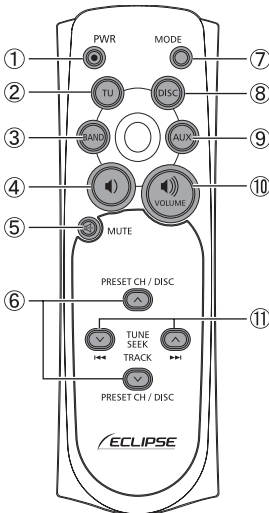

## Cleaning the remote control

- Use a dry cloth to keep the remote control clean. If the remote control unit gets extremely dirty, clean it with a cloth lightly moistened with diluted liquid detergent.
- Never use organic solvents including benzine and lacquer thinner for cleaning. These substances will damage the case or finish.

### Remote control



No.	Button	Name/Working
①		<b>[PWR] button</b> Turns main unit power ON/OFF.
②		<b>[TU] button</b> Switches to the tuner mode.
③		<b>[BAND] button</b> Switches radio band.
④		<b>[ ] button</b> Decreases the volume (including hands-free mode).
⑤		<b>[MUTE] button</b> Activates and deactivates mute.

No.	Button	Name/Working
⑥		[ ∇ PRESET CH ▲ ] buttons [ ∇ DISC ▲ ] button Selects radio preset channels and performs disc mode functions.
		
⑦		[MODE] button Switches audio source mode.
⑧		[DISC] button Switches to DISC mode (CD, CD changer, USB or iPod).
⑨		[AUX] button Switches to AUX mode.
⑩		[  ] button Increases the volume (including hands-free mode).
⑪		[ ∇ TUNE-SEEK ▲ ] buttons [◀◀ TRACK▶▶▶] buttons Selects radio stations and CD tracks.
		

**2** Insert the two batteries as indicated into the battery compartment.

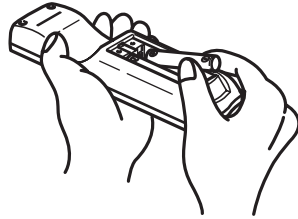

**3** Slide the back cover in the direction indicated by the arrow to close the battery case.



## Replacing the battery

### **WARNING**

To prevent accidents, store batteries out of the reach of children. If a child has swallowed one, consult a doctor immediately.

Use two AAA size batteries.

**1** While pressing the back cover of the remote control unit, slide it in the direction indicated by the arrow to remove it.

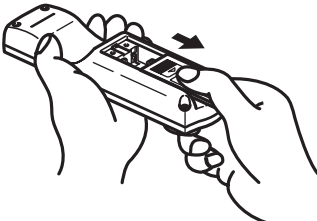

# The Bluetooth hands-free function

## About the Bluetooth hands-free function

The use of Bluetooth wireless communication technology enables a Bluetooth-compatible cell phone to be able to be used with the main unit.

Once the cell phone is connected to the main unit, it is possible to make calls without directly operating the cell phone. Because the connection between the cell phone and the main unit is wireless, communication is possible even when the cell phone is in your bag or pocket. Cable connection and wiring is not necessary.

- The main unit can be used with Bluetooth-compatible cell phones.
- Before using a Bluetooth-compatible cell phone with the main unit, please be sure to perform the Bluetooth registration and connection setting procedures. (For details, refer to "Registering a cell phone" on page 46 and refer to "Connecting a registered cell phone" on page 49.)
- When the cell phone has been connected to the main unit, the Bluetooth connection indicator and the radio wave status/phone connection status indicator appear on the display as shown below.

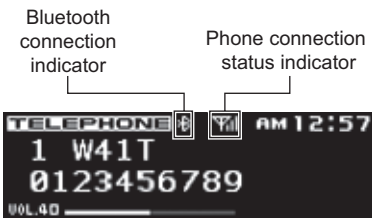

- Once the cell phone has been connected to the main unit, it will remain connected until the connection is cancelled
- Depending on the version of Bluetooth, some cell phones may not be able to communicate with the main unit.

- Depending on the surrounding environment, the connection may become unstable, and the Bluetooth hands-free function may not be able to be operated from the main unit. In such cases, confirm that the connection status is good by referring to the radio wave status indicator on the display, and then repeat the procedure.
- Some cell phones may not be compatible with the main unit.

### ATTENTION

Using Bluetooth may cause batteries in connected devices to drain more quickly.

## About the Bluetooth specifications

The Bluetooth-compatible cell phone to be connected to the main unit must be compatible with the following specifications. (However, depending on the model of the cell phone, some of the functions may be limited.)

### Supported Bluetooth specifications

Bluetooth Specification Ver.2.0

### Supported profile

- HFP (Hands Free Profile) Version 1.5:  
Profile for connection to Bluetooth compatible hands-free devices
- OPP (Object Push Profile) Version 1.1:  
Profile for transmission of address book and schedule

## What is Bluetooth?

---

Bluetooth is a form of short-range wireless communication technology used to connect cell phones and personal computers.

This technology enables hands-free calling and data transmission between Bluetooth-compatible devices.

Please check with your cell phone manual for Bluetooth operation.



Bluetooth is a registered trademark of Bluetooth SIG, Inc.

### **WARNING**

- For safety reasons, the driver must not operate the cell phone while driving.
- State and local ordinances must be strictly followed when using cell phones.

## Setting the Bluetooth hands-free function

---

A variety of settings that can be used when operating the cell phone can be made from the Bluetooth hands-free Phone Setting mode.

- Registration setting:  
To register a cell phone.
- Select Phone setting:  
To select a registered cell phone, and connect, disconnect, or delete it.
- Phone Book setting:  
To store data from the phonebook of the cell phone in the phonebook of the main unit.
- Auto Answer setting:  
To set the cell phone to Auto Answer.
- Ring tone setting:  
To set the ring tone.
- Auto Connect setting:  
To connect a registered cell phone.

- Device INFO display setting:  
To display device information for the main unit.
- Dial setting:  
To enable a phone number to be input using the main unit.
- Delete setting:  
To delete data from the incoming/outgoing call history, preset dial, or phonebook of the main unit.
- Change Code setting:  
To change the passcode.
- SP Select setting:  
To switch the front speaker for audio (speech) output.

## Displaying the Phone Setting selection mode

---

**1**

Press the [/MENU] button for more than one second to select the Bluetooth hands-free mode.

Phone Setting selection mode is activated.

## Registering a cell phone

---

Cell phones can be registered in the main unit. There are two methods that can be used to register a cell phone in the main unit. The cell phone itself can be used or search for cell phones using the main unit. A maximum of five cell phones can be registered in the main unit. Priority of connection will always be in sequential order from 1 to 5. As cell phones are added and deleted, the order will always go by the numbered sequence.

## Registering using a cell phone

If a cell phone is currently connected, it must be disconnected prior to registration of additional cell phones.

**1** In the Phone Setting selection mode, select "Registration" by pressing the [▲] or [▼] button.

**2** Press the [ENTER] button.



### ATTENTION

"NO ENTRY" will be displayed if available. If not, a double beep will be heard if the phone registration memory is not available or full.

**3** Select "Allow Connect" by pressing the [▲] or [▼] button.

**4** Press the [ENTER] button.

The "Waiting" message appears on the display.

**5** Use the cell phone to select the main unit name.

The name of this unit is ECLIPSE BT.



### ATTENTION

- For details on how to operate the cell phone, read its instruction manual.
- Be sure to perform the registration of the cell phone only while the "Waiting" message is on the display.

**6** Use the cell phone to input the passcode.

The default passcode is 1234.



### ATTENTION

For details on how to operate the cell phone, read its instruction manual.

**7**

When the registration has been completed, "COMPLETED" will be displayed.

The cell phone has been registered. (☎ and 📱 appear on the display.)

If the registration has not been successfully completed, the "FAILED" message appears on the display. Repeat the registration procedure.



### ATTENTION

- To register another cell phone to the main unit, press the [S/BAND] button twice after Step 7. Perform the registration procedure from the registered cell phone selection mode in Step 1.
- You cannot register an already registered phone number again.
- Both hands-free function and the audio function may be connected at the same time for some cell phones. In such a case, register the hands-free function of the cell phone first.

### **Searching for cell phones to be registered**

**1** In the Phone Setting selection mode, select "Registration" by pressing the [▲] or [▼] button.

**2** Press the [ENTER] button.

"NO ENTRY" will be displayed if available. If not, a double beep will be heard if the phone registration memory is not available or full.

**3** Select "Device Search" by pressing the [▲] or [▼] button.

**4** Press the [ENTER] button.

"Searching" will be displayed.

#### ATTENTION

"FAILED" will be displayed if cell phone cannot be registered. Repeat Search procedure.

**5** Select a device name of cell phone you want to register by pressing the [▲] or [▼] button.

Each time the [SCREEN/TEXT] button is pressed, the display changes in the following way, and you can register the cell phone using the device address (BD ADD) as well. Device name ↔ Device address (BD ADD) If the device name cannot be obtained during the search, "UNKNOWN" is displayed.

**6** Press the [ENTER] button.

"Waiting" will be displayed.

**7** Use the cell phone to input the passcode.

The default passcode is 1234.

**8** When the registration has been completed, "COMPLETED" will be displayed.

The cell phone has been registered. (☎ and 📶 appear on the display.)

"FAILED" will be displayed if registration is not successful. Repeat Search procedure.

### **Delete a registered cell phone**

**1** In the Phone Setting selection mode, select "Select Phone" by pressing the [▲] or [▼] button.

**2** Press the [ENTER] button.

**3** Select the cell phone you want to delete from memory by pressing the [▲] or [▼] button.

**4** Press the [ENTER] button.

**5** Select "Delete" by pressing the [▲] or [▼] button.

**6** Press the [ENTER] button.

The "DELETE ?" message appears on the display to confirm the cancellation.

**7** Press the [ENTER] button.

**8** "COMPLETED" will be displayed when deletion is successful.

#### ATTENTION

When a cell phone is deleted, all data associated will also be deleted (including history, preset dial, and phonebook) from the main unit.



## Connecting a registered cell phone

---

- 1** In the Phone Setting selection mode, select "Select Phone" by pressing the [▲] or [▼] button.
- 2** Press the [ENTER] button.
- 3** Select the cell phone number you want to connect by pressing the [▲] or [▼] button.
- 4** Press the [ENTER] button.
- 5** Select "Connect" by pressing the [▲] or [▼] button.
- 6** Press the [ENTER] button.

The "Waiting" message appears on the display.

- 7** **"COMPLETED" will be displayed.**

The cell phone is now connected to the main unit.

( and  appear on the display.)

"FAILED" will be displayed if registration is not successful. Repeat the connection procedure.

### ATTENTION

---

Cell phones that have not been registered cannot be connected.

---

## Disconnecting a cell phone

---

- 1** In the Phone Setting selection mode, select "Select Phone" by pressing the [▲] or [▼] button.
- 2** Press the [ENTER] button.
- 3** Select the cell phone number you want to disconnect by pressing the [▲] or [▼] button.
- 4** Press the [ENTER] button.
- 5** Select "Disconnect" by pressing the [▲] or [▼] button.
- 6** Press the [ENTER] button.

The "Disconnect ?" message appears on the display to confirm the disconnection.

- 7** Press the [ENTER] button.

- 8** **"COMPLETED" will be displayed when disconnection is successful.**

## Registering phone number in the phonebook

---

Phone numbers can be registered in the phonebook of the main unit by transferring the phonebook data from the cell phone.

A maximum of 500 phone numbers can be registered for each cell phone.

**1** In the Phone Setting selection mode, select "Phonebook" by pressing the [▲] or [▼] button.

**2** Press the [ENTER] button.

The "DATA Receiving" message appears on the display.

**3** Transmit phonebook data using your cell phone.

**4** "COMPLETED" will be displayed when data transfer is successful.

"FAILED" will be displayed if data transfer is not successful. Repeat the transmit procedure.

### ATTENTION

---



Number of phone numbers that can be registered in the phonebook count as single memories.

- If there is no space remaining in the main unit for phonebook data, the "MEMORY FULL" message appears on the display when an attempt is made to transfer data from the cell phone.
  - Some cell phones cannot transfer all of the phonebook data at once. In this case, transfer one data at a time.
  - If the battery terminal of the vehicle is disconnected, the phonebook data registered in the main unit will be deleted.
- 

## Setting Auto Answer

---

When there is an incoming call, the phone can be set to answer it automatically five seconds after the phone starts ringing.

**1** Select "Auto Answer" by pressing the [▲] or [▼] button in the Phone Setting selection mode.

**2** Press the [ENTER] button.

**3** Select "ON" or "OFF" by pressing the [▲] or [▼] button.

ON:

Auto Answer is activated

OFF:

Auto Answer is disabled

### ATTENTION

---

The default setting for Auto Answer is OFF (Auto Answer is disabled).

---

## Setting the ring tone

---

The ring tone can be set on or off for incoming calls. Ring tone is set ON by default.

**1** In the Phone Setting selection mode, select Ringtone by pressing the [▲] or [▼] button.

**2** Press the [ENTER] button.

**3** Select "ON" or "OFF" by pressing the [▲] or [▼] button.

## Setting Auto Answer for registered cell phones

---

Cell phones which have been registered to the main unit will be connected automatically, if the main unit and the Bluetooth are in an area where connection is possible.

Auto answer is set ON by default and may not be available for all cell phones.

**1** In the Phone Setting selection mode, select "Auto Connect" by pressing the [▲] or [▼] button.

**2** Press the [ENTER] button.

**3** Select "ON" or "OFF" by pressing the [▲] or [▼] button.

ON :

Connects automatically.

OFF :

Must be connected manually.

## Displaying device information for the main unit

---

The name of the device (ECLIPSE BT), the passcode (default setting - 1234), and the BD ADD (device address) can be displayed.

**1** In the Phone Setting selection mode, select "Device INFO" by pressing the [▲] or [▼] button.

**2** Press the [ENTER] button.

The name of the device and Passcode will be displayed.

Pressing the [SCREEN/TEXT] button will toggle between Passcode and BD ADD.

## Enabling phone numbers to be input directly

---

The default setting is OFF.

**1** In the Phone Setting selection mode, select "Dial Setting" by pressing the [▲] or [▼] button.

**2** Press the [ENTER] button.

**3** Select "ON" or "OFF" by pressing the [▲] or [▼] button.

## Deleting data

---

Phonebook, Call History, Preset Dial, and All Data can be deleted.



### ATTENTION

---

If there is no cell phone connected, the data in the phonebook cannot be deleted.

---

### Deleting data from the phonebook

**1** In the Phone Setting selection mode, select "Delete" by pressing the [▲] or [▼] button.

**2** Press the [ENTER] button.

**3** Select the "Phonebook" by pressing the [▲] or [▼] button.

**4** Press the [ENTER] button.

**5** Select "ALL", name, or phone number by pressing the [▲] or [▼] button.

ALL :

Deletes entire phonebook.

Name or phone number :

Only the selected data is deleted.

**6** Press the [ENTER] button.

If ALL is selected "DELETE?" and "ALL" will be displayed.

If a name or phone number is selected "DELETE?" and the name or phone number will be displayed.

**7** Press the [ENTER] button.

**8** When the data in the phonebook has been deleted, "COMPLETED" will be displayed.

### Deleting call history

**1** In the Phone Setting selection mode, select "Delete" by pressing the [▲] or [▼] button.

**2** Press the [ENTER] button.

**3** Select "Outgoing Calls" or "Incoming Calls" by pressing the [▲] or [▼] button.

Outgoing Calls :

Outgoing call history

Incoming Calls :

Incoming call history

**4** Press the [ENTER] button.

If Outgoing Calls is selected "DELETE?" and "Outgoing Calls" will be displayed.

If Incoming Calls is selected "DELETE?" and "Incoming Calls" will be displayed.

**5** Press the [ENTER] button.

**6** When the data in the call history has been deleted, "COMPLETED" will be displayed.

### Deleting preset dial

- 1** In the Phone Setting selection mode, select "Delete" by pressing the [▲] or [▼] button.
- 2** Press the [ENTER] button.
- 3** Select "Preset Dial" by pressing the [▲] or [▼] button.
- 4** Press the [ENTER] button.  
"DELETE?" and "Preset Dial" will be displayed.
- 5** Press the [ENTER] button.
- 6** When the data in preset dial has been deleted, "COMPLETED" will be displayed.

### Deleting all data

- 1** In the Phone Setting selection mode, select "Delete" by pressing the [▲] or [▼] button.
- 2** Press the [ENTER] button.
- 3** Select "ALL" by pressing the [▲] or [▼] button.
- 4** Press the [ENTER] button.  
"DELETE?" and "ALL" will be displayed.
- 5** Press the [ENTER] button.
- 6** When the data has been deleted, "COMPLETED" will be displayed.

### Changing the passcode

The passcode for the main unit can be changed. 4 to 8 digits must be used. The default setting is 1234.

- 1** In the Phone Setting selection mode, select "Change Code" by pressing the [▲] or [▼] button.
- 2** Press the [ENTER] button.  
Passcode and "0\*\*\*\*\*" will be displayed.
- 3** Enter numbers of 0 to 9 by pressing the [▲] or [▼] button.  
[▲]:  
Increases the number.  
[▼]:  
Decreases the number.
- 4** Shift the cursor by pressing the [◀◀] or [▶▶] button.  
[▶▶]:  
Shifts the cursor to the right.  
[◀◀]:  
Shifts the cursor to the left.
- 5** Repeat Steps 3 and 4 to input the passcode to enter the next digit.
- 6** Press the [ENTER] button when you have input the passcode.  
"NewPasscode?" will be displayed.
- 7** Press the [ENTER] button.
- 8** "COMPLETED" will be displayed.

## Switching the speech output

You can switch the front speaker (between Front L, Front R, and Front LR) for output of Bluetooth hands-free speech sound.

- 1** In the Phone Setting selection mode, select "SP Select" by pressing the [▲] or [▼] button.
- 2** Press the [ENTER] button.
- 3** Select "Front L", "Front R", or "Front LR" by pressing the [▲] or [▼] button.

Front L:

Outputs sound from the front left speaker.

Front R:

Outputs sound from the front right speaker.

Front LR:

Outputs sound from both the front right and left speakers.

### ATTENTION

The default speech output is "Front L".

## Selecting the Bluetooth hands-free mode

- 1** Press the [☎/MENU] button.

The Bluetooth hands-free mode is activated.

### ATTENTION

- The Bluetooth hands-free mode can be activated from any audio mode.
- You can return to the previous step anytime by pressing the [↶/BAND] button.

## Making a call

This function enables you to dial phone numbers from the main unit, or to make calls using the stored phone numbers (phonebook) and incoming/outgoing call history.

### Making a call by dialing a phone number

Calls can be made by dialing phone numbers from the main unit.

Before dialing a phone number directly from the main unit, set Dial Setting of the Phone Setting selection mode to ON. (For details, refer to "Enabling phone numbers to be input directly" on page 51.)

- 1** Press the [☎/MENU] button.
- 2** Press the [MODE/TAG] button repeatedly until the "Dial Input" is displayed.
- 3** Enter numbers of 0 to 9 by pressing the [▲] or [▼] button.
  - [▲]:  
Increases the number.
  - [▼]:  
Decreases the number.
- 4** Shift the cursor by pressing the [⏪] or [⏩] button.
  - [⏩]:  
Shifts the cursor to the right.
  - [⏪]:  
Shifts the cursor to the left.
- 5** Repeat the Steps 3 and 4 to input the phone number.

**ATTENTION**

A maximum of 28 digits can be input per phone number.

If you input an incorrect number, move the cursor to that number, and input the correct number by following Step 3.

**6 Press the [ENTER] button when you have input the phone number.**

The input number confirmation screen appears on the display.

**7 Press the [ENTER] button.**

The input phone number is dialed.

***Making a call using preset dial***

Calls can be made using the phone numbers stored to the preset dial buttons.

**1 Press the [☎/MENU] button.****2 Press a preset dial button between [1] and [6].**

The phone number and name stored in the selected preset dial button appear on the display, and the number is dialed (two beeps will be heard if no phone number is stored).

***Making a call using the incoming/outgoing call history***

Calls can be made using phone numbers stored in the incoming/outgoing call history of the main unit.

**1 Press the [☎/MENU] button.****2 Press the [MODE/TAG] button repeatedly until the "Incoming Calls" is displayed. (Incoming call history) message appears on the display.**

The incoming call history appears on the display.

To make a call from the outgoing call history, press the [MODE/TAG] button repeatedly until the "Outgoing Calls" is displayed.

**3 In the History Selection mode, turn the [VOL] knob to select the number you want to call.****4 Press the [ENTER] button.**

The phone number and name stored in the phonebook appear on the display to confirm the number to be dialed.

**5 Press the [ENTER] button.**

The phone number on the display is dialed.

**ATTENTION**

- A maximum of 10 outgoing and 10 incoming call records can be stored in one cell phone. If an attempt is made to store more than 10 call records, the oldest call record will be deleted.
- If the battery of the vehicle is disconnected, the call history stored in the main unit will be deleted.

## Making a call using the phonebook

---

Calls can be made using the phone numbers stored in the phonebook of the main unit.

- 1** Press the [/MENU] button.
- 2** Press the [MODE/TAG] button repeatedly until the "Phonebook" is displayed.
- 3** In the Phonebook Selection screen, turn the [VOL] knob to select the number you want to call.

- 4** Press the [ENTER] button.

The phone number and name stored in the phonebook appear on the display to confirm the number to be dialed.

- 5** Press the [ENTER] button.

The phone number on the display is dialed.

## Making a call from the cell phone

---

Calls can be made using a cell phone which is connected to the main unit.

- 1** Make a call using the cell phone.

### ATTENTION





---

- If the phone number dialed from the cell phone has been stored in the phonebook of the main unit, the name and phone number will appear on the display.
  - Depending on the cell phone, you may have to use the cell phone to talk even when the call has been made from the main unit.
- 

## Receiving a call

---

Calls can be received while in any source mode. There is also an automatic answering function to answer automatically. For details on Auto Answer, refer to "Setting Auto Answer" on page 50.

- 1** When the phone rings, respond with the [ENTER], [, [, [, or [] button.

A phone connection is made, and you can start talking.

## Hanging up (refusing a call)

---

Calls can be terminated or refused.

- 1** Press the [/MENU] button.

The phone call is terminated.

### ATTENTION

---

Calls which have been refused are also stored in memory.

---

## Adjusting the volume

---

The volume of the ring tone and the voice volume can be adjusted.

For safety reasons, do not adjust the volume of the ring tone or the voice volume while driving.

### Adjusting the ring tone volume

---

Adjusting the volume of the ring tone while the phone is ringing.

- 1** Turn the [VOL] knob to adjust the volume.

Turning the [VOL] knob to the right:  
Increases the ringing tone.

Turning the [VOL] knob to the left:  
Decreases the ringing tone.



## Adjusting the voice volume

---

Adjust the voice volume while the call is in progress.

### **1 Turn the [VOL] knob to adjust the volume.**

Turning the [VOL] knob to the right:  
Increases the speech level.

Turning the [VOL] knob to the left:  
Decreases the speech level.

## Storing phone numbers in preset dial

---

It may be convenient for you to store phone numbers that you call regularly in preset dial.

A maximum of 6 phone numbers from the call history or the phonebook can be stored in one cell phone's preset dial.

### **1 Displaying the call history or the phonebook.**

(To display the call history, see page 55.) Select a phone number using the rotary dial. Press enter to confirm the phone number to be stored.

### **2 Press and hold the preset dial button between [1] and [6] that you want to store a number in, until you hear a beep.**

The displayed phone number from the call history or the phonebook is stored in preset dial.

# ESN security operating procedure

## About ESN

---

The main unit is equipped with ESN (ECLIPSE Security Network). A music CD (Key CD) which has been registered in the main unit, is necessary for ESN. Without it, none of the functions will operate, even when the battery is reconnected after it has been disconnected for maintenance, or the ignition switch is turned to ACC or ON after it has been turned to OFF. ESN can be set or cancelled using any of the following methods:

- Key CD security

You can register a music CD in the main unit as the "Key CD" to be used to set or cancel the security settings.

## How to operate the ESN (Key CD) security

---

### *How to program the Key CD*

---

**1** Check that the power of the main unit is in the standby state (with the power turned off).

**2** While pressing the button [6], press the [SCREEN/TEXT] button, and hold both for more than one second.

The "SEC" message appears on the display and changes to the "DISC" message after two seconds.

### ATTENTION

---

- If a CD has already been inserted, "SEC" is shown first and then "Eject DATA DISC" is shown. Eject the disc from tray.
  - If a security is activated, programming the Key CD is not available.
- 

**3** Press the [▲ (OPEN)] button.

The front panel opens.

**4** Insert the Key CD into the disc slot.

**5** Manually close the front panel.

"SEC" is shown and then "Eject DATA DISC" is shown. Eject the disc and close the front panel manually.

### ATTENTION

---

- If there is a problem with the inserted CD, an "ERR" message will appear for two seconds and the CD will be ejected. Reinsert the ejected CD.
  - If the "ERR" message appears on the display twice in a row, the "CHANGE" message will be displayed for two seconds. In this case, try another CD.
  - Copy Protected CD and MP3/WMA CD-ROM cannot be programmed for Key CD security.
  - The Security indicator will flash whenever the vehicle's ignition is switched off.
- 

### *How to cancel the Key CD*

---

**1** Check that the power of the main unit is in the standby state (with the power turned off).

**2** While pressing the button [6], press the [SCREEN/TEXT] button, and hold both for more than one second.

The "SEC" message appears on the display and changes to the "DISC" message after two seconds.

**3 Press the [▲ (OPEN)] button.**

The front panel opens.

**ATTENTION**

If a CD has already been inserted, "SEC" is shown first and then "Eject DATA DISC" is shown. Eject the disc from tray.

**4 Insert the Key CD into the disc slot.****5 Manually close the front panel.**

"CANCEL" is shown first and then "Eject DATA DISC" is shown. Eject the disc from tray, and manually close the front panel.

The ESN setting is deactivated.

**ATTENTION**

If a CD other than the Key CD is inserted, the registration cannot be cancelled. In this case, the "ERR" message is displayed for two seconds, and the CD playback mode is activated.

**How to change the Key CD****1 First, cancel the existing Key CD.**

Refer to "How to cancel the Key CD".

**2 Next, program a new Key CD.**

Refer to "How to program the Key CD".

**How to resume normal operation (ESN security lock out)**

If power is disconnected while ESN security is active (a Key CD was programmed), operation is disabled until power is restored and the main unit unlocked. Follow this procedure to resume normal operation.

**1**

**When the power is turned on after the battery power has been disconnected, the "SEC" message is displayed for two seconds.**

**When the message changes from "SEC" to "DISC", press the [▲ (OPEN)] button.**

**2**

**Insert the Key CD into the disc slot.**

**3**

**Manually close the front panel.**

"OK" will be displayed for two seconds and the CD will begin playing.

**ATTENTION**

- If an incorrect Key CD is inserted, "ERR\_" ("ERR" and error count) message will appear for two seconds and then "Eject DATA DISC" is shown. Eject the disc from tray.
- "ERR5" (Error count 5) appears on the display. Then, "HELP" message will appear and "Eject DATA DISC" is shown. Eject the disc from tray, and manually close the front panel. If the "HELP" message appears, perform the ESN security lock out operation by following the procedure in "What happens if an incorrect CD is inserted?" on page 60.
- You must use the same CD used for Key CD programming; a duplicate CD may not work properly.

## What happens if an incorrect CD is inserted?

- 1 After the 5th incorrect attempt, the "HELP" message will be displayed for five seconds.**

"HELP" will be displayed for 5 seconds. Then the serial number will be displayed.

- 2 Eject the disc from tray, and manually close the front panel.**

- 3 While pressing button [6], press the [SCREEN/TEXT] button, and hold both for five seconds.**

"SEC" will be displayed for two seconds. Then the six digit rolling code will be displayed.

- 4 Press the [SCREEN/TEXT] button.**

"DISC" flashes on the display.

You will have five more attempts to insert correct disc.

- 5 Press the [▲ (OPEN)] button.**

The front panel opens.

- 6 Insert the Key CD into the disc slot.**

"OK" is shown for two seconds and then "Eject DATA DISC" is shown. Eject the disc from tray, and manually close the front panel.

## ATTENTION

- If an incorrect CD is inserted, "ERR\_" ("ERR" and error count) message will appear for two seconds. Then, "Eject DATA DISC" is shown. Eject the disc from tray.
- This process cancels the protection for ESN main unit.

## NOTE

If after 5 tries the correct Key CD is not inserted, the display reads "CALL". Contact ECLIPSE for assistance.

It is easy to forget the name of your Key CD. Make a note of the album name to remind yourself (refer to page 112).

## How to turn the security indicator on/off

Once ESN security is activated, the indicator flashes whenever the vehicle's ignition switch is turned off, warning potential thieves that the main unit is protected. However, if do not want this visible deterrent, it may be turned off.

- 1 When the main unit is in the standby state (with the power turned off), continue to press both [2] and [SCREEN/TEXT] buttons for more than one second.**

- 2 The "IND. FLASH" message or the "IND.-----" message appears on the display.**

"IND. FLASH" means the security indicator will flash when the vehicle's ignition switch is off, and "IND.-----" means it will not. Repeat the above steps to reactivate the flash mode.

## How to read the Electronic Serial Number

---

**1**

Check that the power of the main unit is in the standby state (with the power turned off).

**2**

While pressing button [4], press the [SCREEN/TEXT] button, and hold both for more than one second.

After “ESN” appears on the display, an 8 digit number will appear. This number is the Electronic Serial Number (ESN) of the device. You may use this number to identify your ECLIPSE CD5030 in the event of theft recovery.

# How to operate the AUDIO CONTROL

## Switching audio control modes

Various audio control modes may be fine-tuned using this procedure.

### 1 Press the [ENTER] button for less than one second.

The Audio Control mode will be activated.

### 2 Press the [ENTER] button to select an item to be adjusted.

The items change in the order shown below each time you press the button.

4 Speakers + Sub-Woofer Layout:

BALANCE → FADER → NON-F → LOUDNESS → SVC\*<sup>1</sup> → VOL → BALANCE ...

\*1: Setting cannot be made in FM mode.

### 3 Turn the [VOL] knob to adjust the volume.

Mode	Function	Rotary Mode	
		Left	Right
BALANCE	Adjusts the audio balance of the right and left speakers	Emphasizes the left speakers.	Emphasizes the right speakers.
FADER	Adjusts the audio balance of the front and rear speakers	Emphasizes rear speakers.	Emphasizes front speakers.
NON-F (NON-FADER LEVEL)	Adjusts non-fader level (for subwoofer).	Decrease the sub-woofer level.	Increase the sub-woofer level.
LOUDNESS	The loudness control may be turned on to emphasize low and high frequencies at low volume levels. Loudness boosts bass and treble at low volumes.	Select ON	Select OFF
SVC (Source Volume Control)	Adjusts different volume levels for each audio mode.	Decrease level.	Increase level.

**SVC Setting examples:**

The volume for the default FM mode (default value: 40) is used as a reference for storing the differences in volume that have been set for each audio mode.

Audio mode	FM	AM	CD	USB	BT-Audio
Default value (Volume level)	Reference (40)	0 (40)	0 (40)	0 (40)	0 (40)
SVC setting (Volume level)	Reference (40)	SVC setting value +15 (55)	SVC setting value -10 (30)	SVC setting value +5 (45)	SVC setting value -5 (35)
When volume level in FM mode is adjusted from 40 to 45	45	55 → 60	30 → 35	45 → 50	35 → 40
When volume level in CD mode is adjusted from 35 to 60	45 → 70	60 → 80*	60	50 → 75	40 → 65
When volume level in AM mode is adjusted from 80 to 20	70 → 5	20	60 → 0*	75 → 10	65 → 0
When volume level in USB mode is adjusted from 10 to 35	5 → 30	20 → 45	0 → 20	35	0 → 25

\*: The volume levels can only be set from 0 (min) to 80 (max). The volume difference can be set within a range of -10 to +20.

# How to operate the Sound Adjustment Mode

## About Sound Adjustment Mode

The system has several features that allow you to adjust the acoustic characteristics inside the cabin.

Item	Function	Page
Parametric EQ	You can adjust the 7-band parametric equalizer. This mode is also used to automatically measure the frequency characteristics in the vehicle, and automatically adjust to the smooth characteristics with low distortion based on the measurement data.	68
Time Alignment	The delay time and level for the sound from each speaker can be adjusted in order to correct any phase mismatches in the sound resulting from the listening position. This mode is also used to automatically measure and adjust the sound arrival time in the vehicle. The Time Alignment cannot be specified together with Position selector.	71
Position selector	You can select the speaker level or balance that was preset in each seat. This mode cannot be specified together with Time Alignment.	73
Cross over	Specified frequency bands are allocated to each speaker for improved sound integration.	73
Multi-harmonizer	When original sounds are converted to MP3/WMA format, frequency ranges that are not normally audible to the human ear are compressed. The multi-harmonizer can be used to play back these compressed sounds as close to their original from as possible so that clear and powerful sound can be enjoyed.	74
Non-fader setting	The sub-woofer settings can be performed.	74



## About parametric EQ

Various materials such as sheets or glass are used in the vehicle, absorbing or reflecting sound in different directions. The parametric EQ adjusts and corrects the peak and dip of the frequency.

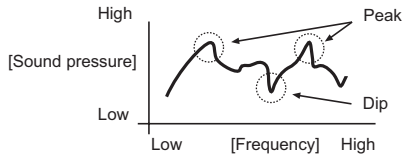

An "equalizer" is a function that corrects these peaks and dips in order to flatten the frequency characteristics. However with a normal graphic equalizer, the median frequency and the Q (sharpness and band width) are fixed, so that when neighboring bands are corrected, there is a limit to the amount by which distortion in the peak and dip characteristics can be corrected. A "parametric equalizer" lets you adjust the median frequency, Q (sharpness and band width) and gain to variable levels, so that you can make fine adjustments to spot areas of the frequency band.

[Parametric equalizer characteristics]

1. Median frequency can be varied.

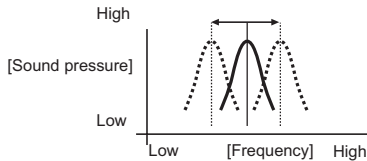

2. Gain can be varied.

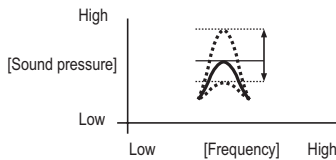

3. Q (sharpness/band width) can be varied.

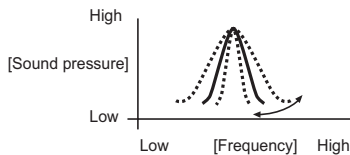

## About time alignment

With vehicle audio systems, the installation position of the speakers and the position of the listener mean that the distances from the listener to the left and right speakers are almost always different. These differences in the distance from the listener to each speaker in turn means that the time taken for the sound to reach the listener is different for each speaker. The result of this is that the phases of each speaker (biases) become mismatched and the sound becomes unnatural, as though the sound stage is not wide enough. The "time alignment" function corrects the time taken for the sound waves to reach the listener in order to set the optimum phase for the listening position so that the sound becomes more expansive as though it is being listened to on a sound stage.

The basic adjustment method involves measuring the actual distances to each speaker and calculating the differences in distance relative to the most distant speaker in order to derive the delay time for the sound from each speaker.

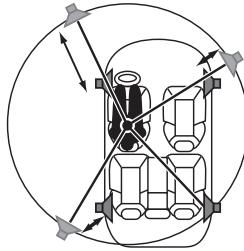

## About crossover

The frequency band that is stored by audio media such as CDs is a fairly wide range from 20 Hz to 20 kHz, and it is difficult for a single speaker to be able to play back all frequencies in such a wide range.

Because of this, several speakers can be used, with different frequency bands (such as treble, medium and bass) allotted to each speaker so that wide frequency ranges can be played back. The "Crossover" function is used to allot the frequency ranges that are to be played back by each speaker in accordance to the installed speaker units and the layout of the speakers, in order to obtain the maximum level of performance from the speakers and to provide the most stable frequency characteristics.

The crossover function includes a high-pass filter (HPF) for playing back treble sounds, and a low-pass filter (LPF) for playing back bass sounds. In addition, the HPF and LPF are used in combination in order to play back sounds in the mid range.

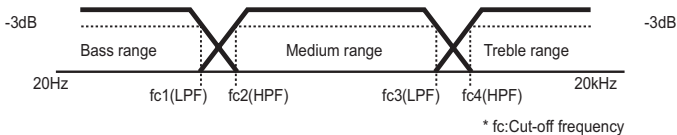

For example, when adjusting the HPF, frequencies that are lower than the specified frequency are progressively dampened, rather than simply not being played back at all. The "slope" adjustment function is the function that is used to adjust these dampening characteristics.

The slope characteristics of a filter are such that with larger slope values (for example 12 dB/oct), the slope becomes steeper, and so the amount of sound mixing in with neighboring bands becomes less so that only the target band is played back. However, it also causes the merging of sound between speakers to become poorer and can result in greater distortion.

- The crossover function is a filter that allocates the specified frequency bands.
- A high-pass filter (HPF) is a filter that cuts out frequencies that are lower than the specified frequency (bass range) and allows higher frequencies (treble range) to pass through.
- A low-pass filter (LPF) is a filter that cuts out frequencies that are higher than the specified frequency (treble range) and allows lower frequencies (bass range) to pass through.
- The slope is the signal level at which frequencies that are one octave higher or one octave lower are dampened.

This system supports the basic speaker systems which comprise front speakers, rear speakers and an added sub-woofer if necessary. In such cases, the crossover can be used to apply the HPF to the front and rear speakers and the LPF to the sub-woofer so that the sound from all speakers merges properly.

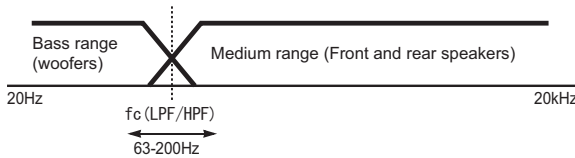

## Switching the sound adjustment mode



- 1 Press the [/MENU] button for more than one second.

The Menu Selection mode will be activated.

- 2 Select "SOUND" by pressing the [] or [] button.

- 3 Press the [ENTER] button.

The Sound Selection mode will be activated.

- 4 Select a setting item by pressing the [] or [] button.

Each time the button is pressed, the setting item changes.

Parametric EQ (Auto EQ) ↔ Time Alignment (Auto TA) ↔ X-Over ↔ Position Selector ↔ Multi Harmonizer ↔ Non-fader Setting ↔ Parametric EQ ...

- 5 Press the [ENTER] button.

This changes to each setting mode.

## Parametric equalizer adjustment (PEQ)

You can adjust the 7-band parametric equalizer. Each band can be set to the following median frequencies:

Band	Adjustable frequency (Hz)
1	63, 80, 100
2	125, 160, 200
3	250, 315, 400, 500
4	630, 800, 1 k, 1.25 k
5	1.6 k, 2 k, 2.5 k, 3.15 k
6	4 k, 5 k, 6.3 k, 8 k
7	10 k, 12.5 k, 16 k

The default for each band is as follows.

Band	Default value (Hz)
1	80
2	160
3	400
4	1 k
5	2.5 k
6	6.3 k
7	12.5 k



### ATTENTION

It is not possible to set more than one band in the same channel and median frequency. Either change the median frequency of the current band, or change the median frequency of another band.

## Manually adjusting the equalizer mode

**1** Select "Parametric EQ" by pressing the [▲] or [▼] button.

**2** Press the [ENTER] button.

This changes to the PEQ setting mode.

**3** Select the band to be adjusted by pressing the [◀◀] or [▶▶] button.

Each time the button is pressed, the band changes in the following order.

[▶▶]:

1 → 2 → 3 → 4 → 5 → 6 → 7 → 1 → ...

[◀◀]:

1 → 7 → 6 → 5 → 4 → 3 → 2 → 1 → ...

**4** Press the [ENTER] button to select the frequency to be adjusted.

Each time the button is pressed, the frequency to be adjusted changes.

**5** Adjust the frequency level by pressing the [▲] or [▼] button.

[▲]:

Increases the level.

[▼]:

Decreases the level.

**6** Adjust the Q curve pattern by pressing the [▲] or [▼] button for 1 second or more.

Each time the button is pressed, the Q curve pattern changes in the following order.

WIDE ↔ Mid WIDE ↔ NORMAL ↔  
Mid NARROW ↔ NARROW ↔  
WIDE ↔ ...

**7** Repeat the steps 3 to 6 to change the settings for each channel and band.

**8**

Press a button from [1] to [4] for more than two seconds to preset a setting value.

The preset value is overwritten by the value set using the above steps.

The time alignment and crossover adjustments will also be stored at this time.

### ATTENTION

The [5] button does not have the equalizer correction function, and you cannot assign a setting value to this button.

## Selecting an equalizer mode from memory

Press a preset button to select the equalizer mode set in memory on the button. The buttons that set equalizer modes in the memory are called preset buttons.

**1**

Select a button from [1] to [4] and press it for less than one second while the PEQ setting mode is activated.

Any of the following patterns can be read from memory.

Button	Pattern
[1]	Pattern with enhanced treble range
[2]	Pattern with enhanced bass and treble ranges
[3]	Pattern with enhanced bass range
[4]	Pattern with enhanced vocal range

## Resetting the Equalizer mode

You can reset the currently saved equalizer adjustment value to the default.

**1**

Hold down the [5] button for more than two seconds.

"Are you sure to initialize all preset EQ?" appears on the display.

**2 Press the [ENTER] button.**

This resets the adjustment values saved in the [1] to [4] buttons to the defaults.

To cancel initializing, press the [**↵**/BAND] button.

 **ATTENTION**

For the default values, see Parametric equalizer adjustment (see page 68).

**Automatically adjusting the equalizer mode (Auto EQ)**

You can measure the frequency characteristics (value) in the vehicle to automatically adjust them to the smooth characteristics with low distortion based on the measurement data if the optional measurement microphone (MEI-100) is connected to this system. The measurement result can be referred to when adjusting the parametric equalizer.

 **ATTENTION**

- Adjust Time Alignment (refer to page 71) and Crossover (refer to page 73) before measuring frequency characteristics.
- When measuring frequency characteristics, Loudness setting is automatically cancelled.
- Close all doors and windows while measurement is in progress.

 **CAUTION**

In order to make the measurement of frequency characteristics easier, slight errors may occur in the measurement data under some circumstances when this function is used. In addition, it is not equivalent to the precise measurements that can be made by specialist measuring devices.

**Measuring frequency characteristics**

**1**

**Connect the RCA connector of the optional microphone (MEI-100) to the L-CH of the AUX jack of the main unit.**

Align the microphone with the actual ear position and attach it to the headrest or other appropriate fixture. (Attach the microphone using tape or string.)

**2**

**Hold down the [ENTER] button on the PEQ screen for more than one second.**

After pressing the button, a 10-second countdown begins. Leave the vehicle during that time.

After ten seconds, pink noise will be output from the speakers and the measurement of the frequency characteristics will start. The "Measuring" message appears on the display while measurement is in progress.

When the measurement is completed, a "COMPLETED" message will appear on the display. Then press the [Enter], [▲], [▼], [▶▶], [◀◀] or [**↵**/BAND] button to go back to PEQ screen and if necessary, adjust each band manually. "Auto EQ" displayed on the screen indicates that the measurement result is active. If the measurement is unsuccessful, a "FAILED" message will appear on the screen. In this case, go back to PEQ screen by pressing the [Enter], [▲], [▼], [▶▶], [◀◀] or [**↵**/BAND] button and repeat the process. You can cancel the measurement by pressing the [**↵**/BAND] button anytime during a measurement process.

The measurement result can be referred to when adjusting parametric equalizer.

### ATTENTION

Bluetooth is temporarily disconnected while measuring frequency characteristics.

## Changing the equalizer mode (Auto EQ) based on the measurement result

### 1 Press button [6].

Each time this button is pressed, the equalizer mode is toggled as follows:

ON ↔ OFF

ON:

AUTO.EQ mode

OFF:

Manual mode

### ATTENTION

You can set the 7-band parametric equalizer in the AUTO.EQ mode to more effectively configure the desired acoustic settings.

## Time alignment adjustment (Time Alignment)

The delay time and level of the sound from each speaker can be adjusted in order to correct any phase mismatches in the sound resulting from the listening position. You can automatically adjust them if the optional measurement microphone (MEI-100) is connected.

### Manually adjusting Time Alignment

#### 1 Select "Time Alignment" by pressing the [▲] or [▼] button.

#### 2 Press the [ENTER] button.

The time alignment setting mode is activated.

#### 3 Press the [ENTER] button to select the speaker band to be adjusted.

Each time the button is pressed, the band changes in the following order.

Front Left → Front Right → Rear Left → Rear Right → Non-Fader → Front Left ...

#### 4 Adjust the time delay in the arrival of the sound by pressing the [◀◀] or [▶▶] button.

The delay time can be adjusted within 0.0 to 10.0 ms (0.1 ms for the main unit).

[▶▶]:

Increases the time.

[◀◀]:

Decreases the time.

 **ATTENTION**

- Refer to the following for the method of calculating the delay time.  
 $A = (B - C) / 34$   
 A: Delay time (ms)  
 B: Distance from the listening position to the furthest speaker (cm)  
 C: Distance from the listening position to the speaker to be adjusted (cm)

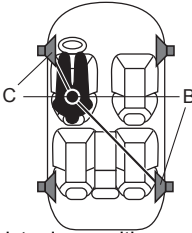

(Example) Listening position:  
 Driver's seat (left)

B: 200 (cm)

C: 50 (cm)

Delay time =  $200 \text{ (cm)} - 50 \text{ (cm)} / 34$   
 = Approx. 4.4 (ms)

- Time Alignment cannot be specified together with Position selector.

**5 Adjust the level by pressing the [▲] or [▼] button.**

[▲]:  
 Increases the dB.

[▼]:  
 Decreases the dB.

**Automatically adjusting Time Alignment (Auto TA)**

You can automatically measure and adjust the delay time and sound level from each speaker if the optional measurement microphone (MEI-100) is connected to this system.

**1**

**Connect the RCA connector of the optional microphone (MEI-100) to the L-ch of the AUX jack of the main unit.**

Align the microphone with the actual ear position and attach it to the headrest or other appropriate fixture.

(When installing the microphone, fix it with a tape or string.)

**2**

**Hold down the [ENTER] button on the Time Align screen for more than one second.**

After pressing the button, a 10-second countdown begins. Leave the vehicle during that time.

After ten seconds, impulses will be output from the speakers and the measurement of the time alignment will start. "Measuring" is shown during measurement.

You can adjust the volume (by turning the [VOL] knob) and restart measurement while it is in progress.

Press the [S/BAND] button once more to cancel measurement.

 **ATTENTION**

- When the speaker band is set to Non-Fader (Sub-woofer), you cannot automatically adjust the time alignment.
- The loudness and position selector functions are turned off during automatic adjustment of the time alignment.
- Bluetooth is temporarily disconnected during automatic adjustment of the time alignment.



## Position selector

---

You can adjust the sound field to the listener seat position.

**1** Select "Position Selector" by pressing the [▲] or [▼] button.

**2** Press the [ENTER] button.

This changes to the Position Selector setting mode.

**3** Select the desired position by pressing the [▲], [▼], [◀◀], or [▶▶] button.

Pressing each button changes the position as follows.

If the same button is re-pressed, the position is reset.

[▲]:  
FRONT

[▼]:  
REAR

[▶▶]:  
FRONT-RIGHT

[◀◀]:  
FRONT-LEFT

### ATTENTION

---

- FADER or BALANCE cannot be specified together with Position selector.
  - Time Alignment cannot be specified together with Position selector.
- 

## Crossover adjustment (X-Over)

---

Specified frequency bands are allocated to each speaker for improved sound integration.

**1** Select "Cross Over" by pressing the [▲] or [▼] button.

**2** Press the [ENTER] button.

The crossover setting mode is activated.

**3** Press the [ENTER] button to set the crossover adjustment channel.

Each time the button is pressed, the channel changes in the following order.

Front → Rear → Woofer → Front → ...

**4** Select the cut-off frequency by pressing the [◀◀] or [▶▶] button.

Each time the button is pressed, the frequency changes in the following order.

Front/Rear:

63 Hz ↔ 80 Hz ↔ 100 Hz ↔ 125 Hz ↔  
160 Hz ↔ 200 Hz ↔ 250 Hz ↔ 315 Hz  
↔ 400 Hz ↔ 500 Hz ↔ 630 Hz ↔ 800  
Hz ↔ 1 kHz ↔ 1.25 kHz ↔ 1.6 kHz ↔ 2  
kHz ↔ 2.5 kHz ↔ 3.15 kHz ↔ 4 kHz ↔  
5 kHz ↔ 6.3 kHz ↔ 8 kHz ↔ 10 kHz

Woofer:

20 Hz ↔ 25 Hz ↔ 31.5 Hz ↔ 40 Hz ↔  
50 Hz ↔ 63 Hz ↔ 80 Hz ↔ 100 Hz ↔  
125 Hz ↔ 160 Hz ↔ 200 Hz

**5** Specify the slope by pressing the [▲] or [▼] button.

The slope can be set to "Pass", "6 dB/oct", "12 dB/oct", "18 dB/oct" or "24 dB/oct".

[▲]:  
The slope becomes more gentle.

[▼]:  
The slope becomes steeper.

**6** Repeat the steps 3 to 5 to change the settings for each channel.

## Multi-harmonizer settings (Harmonizer)

---

This function uses harmonic synthesis to restore the high-frequency component that is lost as a result of the compression process, so that fresher sound can be obtained during MP3/WMA, USB memory playback.

**1** Select "Multi-Harmonizer" by pressing the [▲] or [▼] button.

**2** Press the [ENTER] button.

The harmonizer setting mode is activated.

**3** Select a setting item by pressing the [▲] or [▼] button.

When the button is pressed, the setting item changes in the following order.

... ↔ OFF ↔ Hi ↔ Low ↔ ...

Hi:

High effectiveness

Low:

Low effectiveness

The selected settings will take effect.

## Non-fader settings (Non-F Setting)

---

- Non-Fader Output (Output)

Non-Fader Output can be stereo or mono. Select the method that matches the output method for the sub-woofer system that is connected to the main unit.

- Non-fader phase (Phase)

The merging of sound between the front and rear speakers and the woofer can be improved by selecting the phase. Switch the phase to a phase which lets the speakers combine without any disharmony.

**1** Select "Non-Fader" by pressing the [▲] or [▼] button.

**2** Press the [ENTER] button.

The non-fader setting mode is activated.

### Non-Fader Output settings (Output)

---

**1** Press the [▲] button to select "Output".

**2** Select "Stereo" or "Monaural" by pressings the [▲] or [▼] button.

[▲]:

Stereo

[▼]:

Monaural

### Non-fader phase settings (Phase)

---

**1** Press the [▼] button to select "Phase".

**2** Select "Normal" or "Reverse" by pressing the [▲] or [▼] button.

[▲]:

Normal

[▼]:

Reverse



# Making changes with Display Adjustment Mode

This mode lets you adjust the display brightness, change the button illumination color, etc.

## Switching the Display Adjustment Mode



- 1 Press the [/MENU] button for more than one second.

The Menu selection mode is activated.

- 2 Select "DISP" by pressing the [] or [] button.

- 3 Press the [ENTER] button.

The display adjustment mode is activated.

- 4 Select a setting item by pressing the [] or [] button.

When the button is pressed, the setting item changes in the following order.



Bright ↔ Illumination ↔ DISP Type ↔  
Scroll Type ↔ Bright ↔ ...

- 5 Press the [ENTER] button.

This changes to each setting mode.

## Switching the brightness (Bright)

Default setting is maximum brightness (8).

- 1 Select "Bright" by pressing the [] or [] button.

- 2 Press the [ENTER] button.

The bright setting mode is activated.

- 3 Select the brightness by pressing the [] or [] button.

The brightness is switched in the order shown below each time you press the button. The selected settings will take effect.

Level 1 ↔ Level 2 ↔ Level 3 ↔ Level 4  
↔ Level 5 ↔ Level 6 ↔ Level 7 ↔  
Level 8 ↔ Level 1 ↔ ...

## Changing illumination color

---

You can change the button illumination color in the following way.

**1** Select "Illumination" by pressing the [▲] or [▼] button.

**2** Press the [ENTER] button.

The illumination setting mode is activated.

**3** Press the [▲] or [▼] button.

Pressing the [▲] or [▼] button changes the illumination color as follows. The selected settings will take effect.

Blue ↔ Red

## Changing display type (DISP Type)

---

You can change the display type (Background or Spectrum analyzer).

**1** Select "DISP Type" by pressing the [▲] or [▼] button.

**2** Press the [ENTER] button.

The display type setting mode is activated.

**3** Select a setting item by pressing the [▲] or [▼] button.

When the button is pressed, the setting item changes in the following order.

Background ↔ S/A

**4** Press the [ENTER] button.

Switches among the adjustments modes.

## Changing Background (Background)

---

**1** Select "Background" by pressing the [▲] or [▼] button.

**2** Press the [ENTER] button.

The background setting mode is activated.

**3** Select a setting item by pressing the [▲] or [▼] button.

When the button is pressed, the background changes in the following order.

Motion picture 1 ↔ Motion picture 2

**4** Press the [ENTER] button.

The selected settings will take effect.

## Changing spectrum analyzer (S/A)

---

You can change the spectrum analyzer type.

**1** Select "S/A" by pressing the [▲] or [▼] button.

**2** Press the [ENTER] button.

The spectrum analyzer type setting mode is activated.

**3** Select a setting item by pressing the [▲] or [▼] button.

When the button is pressed, the analyzer type changes in the following order.

Type 1 ↔ Type 2

**4** Press the [ENTER] button.

The selected settings will take effect.

## Changing the scroll type (Scroll Type)

The scroll type of the text display can be changed.

**1** Select "Scroll Type" by pressing the [▲] or [▼] button.

**2** Press the [ENTER] button.

The scroll type setting mode is activated.

**3** Select the scroll type by pressing the [▲] or [▼] button.

Each time the button is pressed, the scroll type changes in the following order.

Once ↔ Repeat

Once:

Text is scrolled once before the display becomes fixed

Repeat:

Text is scrolled repeatedly

The selected settings will take effect.

## Importing display data (DISP Data)

Screens can be downloaded from the ECLIPSE website (E-iSERV) and used instead of the pre-set motion pictures. Download the data by following the instructions on the ECLIPSE website (E-iSERV). After you have downloaded the data onto your PC, copy it to a CD-R and import it into the main unit. (URL: <http://www.e-iserv.jp>) Applications for creating motion pictures can be downloaded, allowing you to create your own screen. Screens can be created by following the procedure shown below: When importing the display to the main unit, turn the power off to set the standby state. For details, see refer to "Turning the power on and off" on page 17.

Select several pages of images to use in your picture.



Access The ECLIPSE website.  
(URL: <http://www.e-iserv.jp>)



Download ECLIPSE's original image editing software (Cutting Board) following the instructions provided by the website.



Using the image editing software (Cutting Board), adjust image size to fit the display. To edit images follow the instructions provided with the editing software.



Convert your edited images into moving pictures following the instructions provided by the image editing software (Cutting Board).



Copy the images to CD-R.



Import into the main unit.

- 1** When the power is off, hold down the [MENU] button for more than three seconds.

The "Customize data?" message appears on the display.

- 2** Select "DISP DATA" by pressing the [▲] or [▼] button.

- 3** Press the [ENTER] button.

The display data import mode is activated, and "Insert DATA DISC" is displayed.

- 4** Press the [▲ (OPEN)] button to open the front panel, and insert a CD-R.

If a CD-R has already been inserted, "Eject DATA DISC" is shown on the display. Press the [▲ (EJECT)] button to eject the CD-R.

- 5** Manually close the front panel.

- 6** Select the desired file by pressing the [▲] or [▼] button.

- 7** Press the [ENTER] button.

- 8** Select the image data to be overwritten by pressing the [▲] or [▼] button.

- 9** Press the [ENTER] button.

Start importing the data into the main unit. If the data has already been imported, it will be overwritten. After import has been completed, "COMPLETED" will be displayed.

Press the [▲ (OPEN)] button to open the front panel, and eject the CD-R. Then manually close the front panel.

 **CAUTION**

If there is no file whose data type is the one you selected in the CD-R, "the NO DATA" message will be displayed and the display returns to the previous screen.

 **ATTENTION**

To load data into the main unit, you have to make a special folder. For detailed information about how to make the folder, refer to the E-iSERV manuals.

 **CAUTION**

- Do not turn the ignition switch or power to the main unit ON or OFF (or remove the front panel of the main unit) while data reading is in progress. Data reading will be interrupted and data may be damaged.
- You cannot operate the main unit while the system is reading data.



# Making changes with Function Mode

A variety of settings can be changed.



## Switching the Function Mode

- 1 Press the [/MENU] button for more than one second.

The Menu selection mode is activated.

- 2 Select "FUNC" by pressing the [] or [] button, and then press the [ENTER] button.

The function mode is activated.

- 3 Select a setting item by pressing the [] or [] button.

When the button is pressed, the setting item changes in the following order.

GuideTone ↔ Clock ON/OFF ↔ Clock Adjust ↔ Demo ↔ HD Radio\*<sup>1</sup> ↔ AUX ON/OFF\*<sup>2</sup> ↔ AUX Sensitivity\*<sup>2</sup> ↔ S/A Sensitivity ↔ BT Audio ON/OFF ↔ BT Audio Setting\*<sup>3</sup>

\*1: This setting can only be chosen when an optional HD Radio tuner unit is connected. For details, see refer to "HD Radio reception settings" on page 89.

\*2: For details, see refer to "Switching the AUX mode on and off" on page 102 and refer to "Changing auxiliary input sensitivity" on page 103.

\*3: For details, refer to "Bluetooth audio setup" on page 36.

## Setting the guide tone

The main unit is set at the factory to emit a beep tone in response to button operation. The guide tone feature may be disabled in the following procedure:

- 1 Select "Guide Tone" by pressing the [] or [] button.

- 2 Press the [ENTER] button.

The guide tone setting mode is activated.

- 3 Select "ON/OFF" by pressing the [] or [] button.



## Setting clock display (Clock ON/OFF)

Switches the clock display to ON/OFF.

- 1 Select "Clock ON/OFF" by pressing the [] or [] button.

- 2 Press the [ENTER] button.

The clock display setting mode is activated.

- 3 Turn the clock display "ON/OFF" by pressing the [] or [] button.

### ATTENTION

The clock display can also be turned on and off by pressing the button [6] while the power is turned off.

## Setting time (Clock Adjust)

---

This main unit uses the 12-hour display notation.

**1** Select "Clock Adjust" by pressing the [▲] or [▼] button.

**2** Press the [ENTER] button.

The clock setting mode is activated.

**3** Select the item to be adjusted by pressing the [◀◀] or [▶▶] button.

[▶▶]:

Minutes will be switched.

[◀◀]:

Hours will be switched.

**4** Adjust the time by pressing the [▲] or [▼] button.

[▲]:

Turns the time forward.

[▼]:

Turns the time back.

**5** Press the [ENTER] button.

## Switching demonstration screen display (Demo)

---

Demonstration screen display settings can be performed.

Default setting is ON. If the demonstration screen display is set to ON, operation, motion picture, and other screens will be displayed in succession.

If you press a button while the demonstration screens are being displayed, the demonstration screens will be cancelled and the audio operation screen will be displayed. If you do not operate the status display function within 15 seconds, the display will return automatically to the demo screen.

**1** Select "Demo" by pressing the [▲] or [▼] button.

**2** Press the [ENTER] button.

The demo display setting mode is activated.

**3** Select "ON/OFF" by pressing the [▲] or [▼] button.



## Setting spectrum analyzer sensitivity (S/A Sensitivity)

---

The sensitivity of the spectrum analyzer display can be changed.

**1** Select "S/A Sensitivity" by pressing the [▲] or [▼] button.

**2** Press the [ENTER] button.

The spectrum analyzer sensitivity setting mode is activated.

**3** Select the sensitivity of the spectrum analyzer by pressing the [▲] or [▼] button.

When the button is pressed, the spectrum analyzer sensitivity changes in the following order.

Hi ↔ Mid ↔ Low ↔ Hi ↔ ...

**4** Press the [ENTER] button.

The selected settings will take effect.



### ATTENTION

---

The spectrum analyzer display is initially set to the "Mid" (Middle) sensitivity.

---

## Setting the steering remote function (U.S.A. only)

---

The CD5030 supports two types of function setup: (1) Automatic assignment of steering remote functions to the steering switch buttons using the steering remote data you have downloaded from the ECLIPSE Web site (E-iSERV), and (2) Manual assignment of steering remote functions to the steering switch buttons using the downloaded data. The steering remote functions installed at the factory before shipment cannot operate this main unit.

## Automatic setup of steering remote functions (U.S.A. only)

Download the steering remote function data from the ECLIPSE Web site (E-iSERV), copy this data on a CD-R disc, and load the disc data onto this main unit. The steering remote functions will be assigned to the steering switch buttons automatically.

To do so, download the steering remote function data and load it onto this main unit in the following procedure.

Access The ECLIPSE website.  
(URL: <http://www.e-iserv.jp>)



Download the steering remote software following instructions provided on the ECLIPSE website (E-iSERV). (Because material available on the website may not be compatible with the steering remotes found on some automobiles, make sure to check the website for details about compatibility.)



Copy the downloaded software to CD-R.



Import into the main unit.



The steering remote can be operated.



### ATTENTION

For details about the automatic setup of steering remote functions, contact the store where you purchased your main unit. Note that the data downloaded from the ECLIPSE Web site may be incompatible to your vehicle model or main unit model. For a compatibility problem or the setup procedure, consult the store where you purchased your CD5030.

## Reading steering remote data (U.S.A. only)

Before loading the steering remote function data to this main unit, be sure to turn the power Off and set the main unit to the standby status. For details, see refer to "Turning the power on and off" on page 17.

**1** When the power is off, hold down the [MENU] button for more than three seconds.

"Customize data?" appears on the display.

**2** Select "STEERING SW" by pressing the [▲] or [▼] button.

**3** Press the [ENTER] button.

**4** Select "Data Read" by pressing the [▲] or [▼] button.

**5** Press the [ENTER] button.

The steering remote setting mode is activated, and "Insert DATA DISC" is shown on the display.

**6** Press the [OPEN] button to open the front panel, and insert a CD-R.

If a CD-R has already been inserted, "Eject DATA DISC" is shown on the display. Press the [EJECT] button to eject the CD-R.

**7** Manually close the front panel.

**8** Select the desired file by pressing the [▲] or [▼] button.

**9 Press the [ENTER] button.**

The CD-R is read. While it is reading, "READING" is displayed.

After data reading has completed, "COMPLETED" is shown for two seconds on the display, and then "Eject DATA DISC" appears.

**10 Press the [▲ (OPEN)] button to open the front panel, and eject the CD-R.**

 **ATTENTION**

- To load data into the main unit, you have to make a special folder. For detail information about how to make the folder, refer to the E-ISERV website.
- This function is available only for vehicles equipped with steering remote with an interface that operates by detecting voltage.

 **CAUTION**

- Do not turn the ignition switch or power to the main unit ON or OFF (or remove the front panel of the main unit) while data reading is in progress. Data reading will be interrupted and data may be damaged.
- Only the Volume control can be operated while the system is reading data.

**Manual setup of steering remote functions (U.S.A. only)**

You can manually assign a function to each steering switch button.

To do so, turn the power supply off and set it to the standby state. For details, see refer to "Turning the power on and off" on page 17.

**1 When the power is off, hold down the [◀/MENU] button for more than three seconds.**

"Customize data?" appears on the display.

**2 Select "STEERING SW" by pressing the [▲] or [▼] button.**

**3 Press the [ENTER] button.**

**4 Select "Manual set" by pressing the [▲] or [▼] button.**

**5 Press the [ENTER] button.**

"Long push MODE button" appears on the display.

**6 Hold down the [MODE/TAG] button for more than two seconds.**

The Manual steering remote setting mode is selected.

 **ATTENTION**

If "FAILED" is shown on the display, press the [MODE/TAG] button again for more than two seconds.

**7 Select a desired function to set by pressing the [▲] or [▼] button.**

A function is selected in the following sequence each time you press the button.

TRACK UP ↔ TRACK DOWN ↔ VOL UP ↔ VOL DOWN ↔ MODE ↔ MUTE ↔ POWER ↔ ON HOOK ↔ OFF HOOK ↔ OTHER ...

**8 Press the [ENTER] button.**

"Long push Steering SW and MODE button" appears on the display.

**9 While holding down the steering switch button to store the function, press the [MODE/TAG] button for more than two seconds.**

When the function is set correctly, "OK" appears on the display.



**ATTENTION**

---

If "FAILED" is shown on the display, once again select a desired function to set.

---

**10 Set more functions to the steering switch buttons by repeating Steps 7 through 9.**



**ATTENTION**

---

When you have set 10 functions to the steering switch buttons, "COMPLETED" is shown and the manual function setting is completed.

---

**11 When you have set all functions, hold down the [ENTER] button for more than one second.**

"COMPLETED" appears on the display, and the manual function setting is completed.

## Compatibility with various switches

The compatibility of the main unit's various modes and the steering remotes installed on your vehicle are as follows:

Switch Name *1	Button function	Mode						
		Tuner	Disc/USB mode	AUX	iPod	Power OFF	BT-Audio mode	BT-TEL mode
TRACK+	Press briefly	TUNE UP	TRACK UP	—	TRACK UP	—	TRACK UP	—
	Press and hold	SEEK UP*2	FAST UP	—	FAST UP	—	FAST UP	—
TRACK-	Press briefly	TUNE DOWN	TRACK DOWN	—	TRACK DOWN	—	TRACK DOWN	—
	Press and hold	SEEK DOWN*2	FAST DOWN	—	FAST DOWN	—	FAST DOWN	—
VOL+	Press briefly	Increases the volume	Increases the volume	Increases the volume	Increases the volume	—	Increases the volume	Increases the volume (ring tone/speakers' voices)
	Press and hold	Gradually increases the volume	Gradually increases the volume	Gradually increases the volume	Gradually increases the volume	—	Gradually increases the volume	Increases the volume gradually (ring tone/speakers' voices)
VOL-	Press briefly	Decreases the volume	Decreases the volume	Decreases the volume	Decreases the volume	—	Decreases the volume	Decreases the volume (ring tone/speakers' voices)
	Press and hold	Gradually decreases the volume	Gradually decreases the volume	Gradually decreases the volume	Gradually decreases the volume	—	Gradually decreases the volume	Decreases the volume gradually (ring tone/speakers' voices)
MODE	Press briefly	Switches to the next mode	Switches to the next mode	Switches to the next mode	Switches to the next mode	Power ON in the last mode	Switches to the next mode	Switches to the next mode
	Press and hold							
MUTE	Press briefly	MUTE	MUTE	MUTE	MUTE	—	MUTE	—
	Press and hold	—	—	—	—	—	—	—
POWER	Press briefly	Power OFF	Power OFF	Power OFF	Power OFF	Power ON in the last mode	Power OFF	Power OFF
	Press and hold	—	—	—	—	—	—	—

## Various Settings

Switch Name <sup>*1</sup>	Button function	Mode						
		Tuner	Disc/USB mode	AUX	iPod	Power OFF	BT-Audio mode	BT-TEL mode
ON HOOK	Press briefly	—	—	—	—	—	—	ON HOOK
	Press and hold	—	—	—	—	—	—	—
OFF HOOK	Press briefly	The TEL mode is activated.	The TEL mode is activated.	The TEL mode is activated.	The TEL mode is activated.	The TEL mode is activated.	The TEL mode is activated.	OFF HOOK
	Press and hold	—	—	—	—	—	—	—

\*1: Switch names change depending on vehicle make and model.

\*2: If a SIRIUS/XM satellite radio tuner (purchased separately) is connected, categories can be switched when in the satellite mode.

# How to operate the main unit with an optional CD changer connected

This section covers the operation of an optional CD changer that is connected to the main unit.

## Listening to a CD

- 1 Hold down the [SOURCE/PWR] button for less than one second until the CD changer mode is shown.

For details, refer to "Switching Audio Modes" on page 17.

## Advancing to the next track or returning to the beginning of the track being played

- 1 Hold down the [⏮] or [⏭] button for less than one second.

[⏭]:  
Advances to the next track.

[⏮]:  
Returns to the beginning of the track being played.  
(Repeat pressing for previous tracks.)

## Operations during rotary mode

- 1 Turn the [VOL] knob.

Turn to the right:  
Advances to the next track.

Turn to the left:  
Return to the beginning of the track being played.  
Repeat turning for previous tracks.

## Fast forward/rewind

Fast forward or rewind the song currently being played.

- 1 Hold down the [⏮] or [⏭] button.

[⏭]:  
Fast forwards.

[⏮]:  
Fast rewinds.

## Playing the beginning of tracks (SCAN)

- 1 Press the [4 SCAN] button.

Pressing the button for less than one second causes the changer to move up to the next track and play it for 10 seconds, then move up to the next track and play it for 10 seconds, and so on, on one CD, until the button is pressed again.

Press the button for longer than a second to play the first 10 seconds of the first track of every CD loaded.



### ATTENTION

- To continue playing a desired track, press the button again to stop scanning.
- After the entire disc is scanned once, ordinary playback starts from the point where scanning started.

## Repeating the same track (REPEAT)

### 1 Press the [5 RPT] button.

Pressing on the button for less than one second causes the changer to repeat the track currently being played, until the button is pressed again.

Press the button for longer than a second to repeat all tracks on the CD being played.

## Playing tracks in random order (RANDOM)

### 1 Press the [6 RAND] button.

Pressing on the button for less than one second causes the changer to play the tracks on the currently playing CD in random order, until the button is pressed again.

Press the button for longer than a second to play tracks from all of CDs loaded in the currently selected changer, in random order. Tracks can be repeated during random play. This is not an abnormal occurrence.

### ATTENTION

- During random playback, press the [5 RPT] button to repeat the track being played. To cancel the repeat play (and return to random play), press the [5 RPT] button again.
- When any of the functions - "Playing the beginning of tracks", "Repeating the same track" and "Playing tracks in random order" - is selected, a message such as "SCAN", "ALL SCAN", "REPEAT", "ALL REPEAT", "RANDOM" or "ALL RANDOM" will appear on the display to verify the current function.

- Random play is not cancelled even if a magazine is ejected.

## Skipping to the next or previous CD

### 1 Press the [▲] or [▼] button.

- [▲]:  
Selects the next higher number disc.
- [▼]:  
Selects the next lower number disc.

## Specifying a CD to play

A CD of your choice is directly selectable out of the loaded discs.

### 1 Press the [MODE/TAG] button for more than one second.

### 2 Press a button from [1] to [6].

Buttons	1	2	3	4	5	6
CD	1	2	3	4	5	6
	7	8	9	10	11	12

To select a CD from nos. 7 to 12, press the desired button considerably longer.

### 3 Press the [MODE/TAG] button for more than one second to exit the direct selection mode.



# How to operate the tuner with an optional HD Radio tuner connected (U.S.A. only)

## About HD Radio

---

If the optional HD Radio tuner unit is connected, terrestrial digital broadcasts can be received. When terrestrial digital broadcasts are received, the FM reception has the same sound quality as a CD, and the AM reception has the same sound quality as conventional FM sound. Depending on the reception status, HD Radio may also be able to receive analog broadcasts, which means reception is still possible in regions with no digital coverage.



The "HD Radio Ready" logo is a registered trademark of iBiquity Digital Corp.

There are both automatic and manual methods (one of each) for storing stations in memory. The main unit will accept up to 24 stations in memory. There are 6 stations for AM and 18 stations for FM (6 each for FM1, FM2 and FM3) (initial settings).

Refer to "How to operate the tuner" on page 40 for information on the following operations:

- Listening to the tuner
- Tuning to a station
- Entering stations into memory automatically (The automatic preset mode: ASM)
- Manually setting stations into memory
- Preset station scan

During digital broadcast reception, the "DIGITAL" message appears on the display.

## Switching between displays when receiving HD Radio

---

During digital reception, the name of the station being received and other information can be displayed.

### 1 Press the [SCREEN/TEXT] button for more than one second.

Each time the button is pressed, the display item changes in the following order:

Station name → Genre → Title\* → Artist\* → Album\*

\*: Depending on the nature of the broadcast, no information may be shown.

## HD Radio reception settings

---

The HD Radio reception method can be selected. When the HD Radio tuner is connected to this main unit for the first time, it will be set at [AUTO1] (that preferentially receives digital broadcasts).

### 1 Press the [MENU] button for more than one second.

The Menu selection mode is activated.

### 2 Select "FUNC" by pressing the [▲] or [▼] button, and then press the [ENTER] button.

The function mode is activated.

### 3 Select "HD Radio" by pressing the [▲] or [▼] button.

### 4 Press the [ENTER] button.

The reception setting screen is displayed.

**5** Select a setting item by pressing the [▲] or [▼] button.

The HD Radio switches in the order shown below each time the buttons are pressed.

AUTO1 ↔ AUTO2 ↔ OFF ↔ AUTO1  
↔ ...

**AUTO1:**

Preferentially receives digital broadcasting that is in the receivable state. In areas where digital reception is not possible, reception is automatically switched to the analog broadcasting reception mode to avoid loss of reception.

**AUTO2:**

Preferentially receives digital broadcasting that is in the receivable state. In areas where digital reception is not possible, reception is automatically switched to the analog broadcasting reception mode to avoid loss of reception. Automatic scanning is available only for digital broadcasting. For automatic tuning, see page 40.

**OFF:**

Receives only analog broadcasting.

The display shows "DIGITAL" while a digital broadcasting is being received. This is cleared during analog reception.

## Tuning to a sub channel (SPS)

---

When a station selected in the HD Radio has sub channels (SPS), "P\_" (\_: number of sub channels) is shown on the display, and you can select sub channels.

**1** Press the [▲] or [▼] button for less than one second.

Each time the button is pressed, the sub channel changes.

[▲]:

Advances to the next sub channel.

[▼]:

Returns to the previous sub channel.

## Storing tag information about the currently played track (Tagging)

You can use HD Radio to store tag information about the currently played track. Tag information for each track is automatically transferred to the iPod when it is connected to the main unit. You can use tag information about the tracks transferred to the iPod to purchase the desired tracks via iTunes.

The main unit can save tag information about tracks only when the tag indicator appears on the display.

iPod and iTunes are trademarks of Apple Computer, Inc., registered in the U.S.A. and other countries.

### 1 When your favorite track was played, hold down the [MODE/TAG] button for more than one second.

The tag information about the the favorite track is stored in the main unit.

This main unit can transfer the tag information stored in the following iPod models (including the software versions), and you can purchase desired tracks via iTunes.

Model	Software version
iPod 5G	1.2.3
iPod classic	1.0.0
iPod classic 120GB	2.0.0
iPod nano 3G	1.0.0
iPod nano 4G	1.0.2
iPod touch 1G	2.1.0
iPod touch 2G	2.1.1
iPhone	2.1.0
iPhone 3G	2.1.0

### ATTENTION

This main unit can store up to 50 sets of tag information.

# How to operate the tuner with an optional XM satellite radio tuner connected (U.S.A./CANADA only)

## About XM satellite radio

---

If the optional XM satellite radio tuner unit is connected, satellite radio broadcasts can be received.

With XM satellite radio, over 170 channels are available including music, sports, news, and entertainment programs.

The channel can be selected from categories such as ROCK and DANCE, or by selecting individual channels manually.

Reception of XM satellite radio is fee based; you have to subscribe to it.

It is possible to subscribe through the XM radio website.

URL: <http://www.xmradio.com>

### ATTENTION

---

- For details on the settings and operation of the XM satellite radio tuner unit, refer to the XM satellite radio unit owner's manual.
- The main unit will accept up to 24 stations in memory.

## Selecting the radio mode

---

- 1** Hold down the [SOURCE/PWR] button for less than one second until the XM satellite radio mode is shown.

For details, refer to "Switching Audio Modes" on page 17.

## Selecting a channel

---

- 1** Hold down the [↔/BAND] button for less than one second to switch to the desired XM band.

The radio bands will switch from XM1 → XM2 → XM3 → XM4 in order each time the button is pressed.

- 2** Tune to the desired channel by pressing the [▲] or [▼] button.

[▲]:  
Selects a higher channel.

[▼]:  
Selects a lower channel.

- 3** Start the automatic channel search by pressing the [◀◀] or [▶▶] button for more than one second.

Reception is enabled for all channels within the currently selected category.

(See Refer to page 93 for details on "Category selection".)

[▶▶]:  
Starts searching for higher channels.

[◀◀]:  
Starts searching for lower channels.

## Operations during rotary mode

---

- 1** Turn the [VOL] knob right or left.

Turn to the right:  
Tunes to higher channels.

Turn to the left:  
Tunes to lower channels.

## Category selection

The channel can be selected from among categories such as ROCK and DANCE.

Consult the XM website for the details of the categories.

- 1 **Hold down the [◀◀] or [▶▶] button for less than one second.**

Each time the button is pressed, the category changes.

[▶▶]:

Advances to the next category.

[◀◀]:

Returns to the previous category.

## Direct channel selection

The channel can be selected by inputting the channel directly.

- 1 **Press the [MODE/TAG] button for more than one second.**

The mode will change to the direct channel selection mode.

- 2 **Select the channel number by pressing the [◀◀] or [▶▶] button.**

[▶▶]:

Advances to the next number.

[◀◀]:

Returns to the previous number.

- 3 **Select channel number to be input by pressing the [▲] or [▼] button.**

Each time the button is pressed, the channel number changes in the following order.

0 ↔ 1 ↔ 2 ↔ 3 ↔ 4 ↔ 5 ↔ 6 ↔ 7 ↔  
8 ↔ 9 ↔ 0 ↔ ...

- 4 **Press the [ENTER] button.**

Reception starts.

## Manually storing channels into memory

This section covers the storing of channels in the numbered buttons in memory.

- 1 **Select the channel to be stored by pressing the [▲] or [▼] button.**

- 2 **Select any button, from [1] to [6], and press it for more than two seconds.**

The tuned channel is now memorized and stored in the button selected. Repeat the procedure to manually store the tuned channels into memory, in turn, for buttons [1] to [6]. These buttons are called the preset buttons.



### ATTENTION

If the vehicle's battery is disconnected (for repairs to the vehicle or when removing the main unit), all channels stored in memory will be lost. In such cases, store the channels in memory again.

## Preset channel scan

This function enables the reception of all the channels in the preset buttons for five seconds each.

- 1 **Hold down the [▼] button for more than one second.**

"P SCAN" will appear on the display, and channels stored in preset buttons [1] through [6] will be received for five seconds each.

- 2 **To stop the preset scan mode at the desired channel, press the [▼] button again.**

The main unit will stay tuned to the desired channel.

## Switching displays when using the XM satellite radio

---

### **1** Press the [SCREEN/TEXT] button for more than one second.

Each time the button is pressed, the display item changes in the following order:

Channel name → Category name →  
Title → Name → Channel name → ...



### ATTENTION

---

If there are no names, the "NO DATA" message will appear.

---

# How to operate the tuner with an optional SIRIUS satellite radio tuner connected (U.S.A./CANADA only)

## About SIRIUS satellite radio

---

If the optional SIRIUS satellite radio tuner unit is connected, satellite radio broadcasts can be received.

With SIRIUS satellite radio, over 130 channels are available, including music, sports, news, and entertainment programs.

The channel can be selected from categories such as POP and ROCK, or by selecting individual channels manually.

Reception of SIRIUS satellite radio is fee based; you have to subscribe to it.

It is possible to subscribe through the SIRIUS radio website.

URL: <http://www.sirius.com>

### ATTENTION

---

- For information about the operation and set-up of the SIRIUS satellite radio tuner unit, refer to the SIRIUS satellite radio unit's owner's manual.
  - The main unit will accept up to 24 stations in memory.
- 

## Selecting the radio mode

---

- 1** Hold down the [SOURCE/PWR] button for less than one second until the SIRIUS satellite radio mode is shown.

For details, refer to "Switching Audio Modes" on page 17.

## Selecting a channel

---

- 1** Hold down the [↔/BAND] button for less than one second to switch to the desired SIRIUS band.

Each time the button is pressed, the radio band changes in the order SIRIUS1 → SIRIUS2 → SIRIUS3 → SIRIUS4.

- 2** Tune to the desired channel by pressing the [▲] or [▼] button.

[▲]:  
Selects a higher channel.

[▼]:  
Selects a lower channel.

- 3** Start the automatic channel search function by pressing the [◀◀] or [▶▶] button for more than one second.

Reception is enabled for all channels within the currently selected category. (See Refer to page 96 for details on "Category selection".)

[▶▶]:  
Starts searching for higher channels.

[◀◀]:  
Starts searching for lower channels.

## Operations during rotary mode

---

- 1** Turn the [VOL] knob right or left.

Turn to the right:  
Tunes to higher channels.

Turn to the left:  
Tunes to lower channels.

## Category selection

---

The channel can be selected from among categories such as POP and ROCK.

Consult the SIRIUS website for the details of the categories.

### 1 Hold down the [◀◀] or [▶▶] button for less than one second.

Each time the button is pressed, the category changes.

[▶▶]:

Advances to the next category.

[◀◀]:

Returns to the previous category.

## Direct channel selection

---

The channel can be selected by inputting the channel directly.

### 1 Press the [MODE/TAG] button for more than one second.

The mode will change to the direct channel selection mode.

### 2 Select the channel number by pressing the [◀◀] or [▶▶] button.

[▶▶]:

Advances to the next number.

[◀◀]:

Returns to the previous number.

### 3 Select channel number to be input by pressing the [▲] or [▼] button.

Each time the button is pressed, the channel number changes in the following order.

0 ↔ 1 ↔ 2 ↔ 3 ↔ 4 ↔ 5 ↔ 6 ↔ 7 ↔  
8 ↔ 9 ↔ 0 ↔ ...

### 4 Press the [ENTER] button.

Reception starts.

## Manually storing channels into memory

---

This section covers the storing of channels in the numbered buttons in memory.

### 1 Select the channel to be stored by pressing the [▲] or [▼] button.

### 2 Select any button, from [1] to [6], and press it for more than two seconds.

The tuned channel is now memorized and stored in the button selected. Repeat the procedure to manually store the tuned channels into memory, in turn, for buttons [1] to [6]. These buttons are called the preset buttons.



## ATTENTION

---

If the vehicle's battery is disconnected (for repairs to the vehicle or when removing the main unit), all channels stored in memory will be lost. In such cases, store the channels in memory again.

## Preset channel scan

---

This function enables the reception of all the channels in the preset buttons for five seconds each.

### 1 Hold down the [▼] button for more than one second.

"P SCAN" will appear on the display, and channels stored in preset buttons [1] through [6] will be received for five seconds each.

### 2 To stop the preset scan mode at the desired channel, press the [▼] button again.

The main unit will stay tuned to the desired channel.



## Switching displays when using the SIRIUS satellite radio

---

### **1** Press the [SCREEN/TEXT] button for more than one second.

Each time the button is pressed the display item changes in the following order:

channel name → category name → title → artist → composer → channel name → ...

### **ATTENTION**

---

If there are no names, the "NO DATA" message will appear.

---

# How to operate the main unit with the optional direct cable for iPod® connected

When the iPod is connected to the main unit using the optional iPod® direct cable (iPC-109), you can listen to iPod music files. You can handle the iPod functions through the main unit or iPod by switching the settings.

For details on the connection, settings, and other conditions of the iPod® direct cable, refer to the OWNER'S MANUAL of the iPod® direct cable. If the portable audio equipment has already been connected, iPod is not available.

iPod is for legal or right holder-authorized copying only. Don't steal music. iPod is a trademark of Apple Computer, Inc., registered in the U.S.A. and other countries.

"Made for iPod" (iPod support product) is an electric product accessory that is especially designed to connect iPod, and means a product for which the conformity with the Apple performance standard was approved by the developer.

Apple does not take any responsibility for operations of this machine and the conformity with the safety and control standard.

## Listening to iPod music files (If an iPod is not connected)

---

### **1** Connect the iPod using the optional direct cable for iPod.

The iPod will begin playing once it is connected.



### ATTENTION

---

- The iPod will begin playing the music file it was playing before being connected. If the main unit cannot detect the music file that was playing previously, it will begin playing from the first music file.
  - When the iPod is connected using the iPod optional direct cable, the "ECLIPSE" message will appear on the iPod. Note that the ECLIPSE logo is displayed for all models except for the iPod Touch. While "ECLIPSE" is shown, you cannot directly operate the iPod. When directly handling the iPod, switch the operations.
- 



### CAUTION

- Disconnect headphones and all other accessories from the iPod before connecting it to the optional direct cable for iPod. Failure to do so may make it impossible to operate the iPod from the main unit.
- If the iPod's equalizer has been customized, the sound output may be distorted when it is connected to the optional direct cable for iPod.

## Listening to iPod music files (If an iPod is connected)

---

**1**

**Hold down the [SOURCE/PWR] button for less than one second until the iPod mode is shown.**

For details, refer to "Switching Audio Modes" on page 17.

## Switching the operation mode

You can control the iPod functions directly from the main unit or from the iPod by switching the operation mode.

- 1 Press the [MODE/TAG] button for more than one second.

The iPod operation mode is switched each time you press the button.

### ATTENTION

For the iPod operations, see the iPod owner's manual.

## Advancing to the next music file or returning to the beginning of the music file being played

- 1 Hold down the [◀◀] or [▶▶] button for less than one second.

[▶▶]:

Advances to the next music file.

[◀◀]:

Returns to the beginning of the music file being played. (Keep pressing for previous music files.)

## Fast forward/rewind

- 1 Hold down the [◀◀] or [▶▶] button.

[▶▶]:

Fast forwards.

[◀◀]:

Fast rewinds.

## Switching the list

You can switch the list in each mode.

- 1 Press the [▲] or [▼] button.

[▲]:

Switched to the list in the previous level.

[▼]:

Switched to the list in the next level.

## Searching for a music file

The iPod search mode can be operated from the main unit.

- 1 Press the [MODE/TAG] button for less than one second.

The search mode is activated.

- 2 Turn the [VOL] knob to select the search mode item.

Search mode items are selected in the following order.

Playlists ↔ Artists ↔ Albums ↔ Songs  
 ↔ Podcasts ↔ Audiobooks ↔ Genres  
 ↔ Playlists

**3 Press the [ENTER] button.**

The following information is displayed according to the selected search mode item.

**Playlists:**

The playlist selected on the iPod is displayed.

**Artists:**

Artist names are displayed

**Albums:**

Album names are displayed.

**Songs:**

Music file names are displayed.

**Podcasts:**

EPISODE names are displayed.

**Audiobooks:**

Audio book file names are displayed.

**Genres:**

Genre names are displayed.

**4 Turn the [VOL] knob to select the desired search mode item, and then press the [ENTER] button.**

If "SONGS" or "AUDIOBOOK" is selected, the selected song or "AUDIOBOOK" will be played. If a different search mode item is selected, the selection process is continued until any song or program is selected. All the files of the selected list (playlist, artist, album, podcast, or genre) are played and repeated.

When you press the [▲] or [▼] button for less than one second, you can call the next or previous list of 10 tracks. Hold down this button more than one second to continue calling the next or previous track lists.



**ATTENTION**

- Each search item mode will display information in the following order before displaying music file information.

Search mode	Display order
Playlists	Playlists → Songs
Artists	Artists → Albums → Songs
Albums	Albums → Songs
Songs	Songs
Podcasts	Episode → Podcast
Audiobooks	Audiobook
Genres	Genres → Artists → Albums → Songs

## Repeating the same music file (REPEAT)

---

### 1 Press the [5 RPT] button.

Pressing this button causes the iPod to repeat the music file currently being played, until the button is pressed again.

## Playing music files in random order (SHUFFLE)

---

### 1 Press the [6 RAND] button.

The random order of music files to be played changes as follows each time you press the button for less than one second.

Random play of music files of currently played album → Random play of music files of all albums in the iPod → OFF →...

If you press the button for more than one second, the random play of all music files in the iPod starts.

### ATTENTION

---

- When either of the functions- REPEAT or RANDOM is selected, a message such as "RPT", "ALL-RAND" or "RAND" appears on the display to verify the current function.
  - REPEAT and RANDOM both operate in the same manner as the REPEAT and SHUFFLE modes on iPod.
- 

## Displaying text

---

The display can be switched to show the album name, the artist name and the song name.

### 1 Press the [SCREEN/TEXT] button for more than one second.

The album name, the artist name and the song name are scrolled and displaying, the information is displayed in the following order.

Albums → Artists → Songs → Albums...

### ATTENTION

---

- Text recorded with characters other than alphanumeric characters and symbols cannot be displayed.
  - Characters that cannot be displayed are displayed as \* (asterisks).
  - If there is no text stored in a music file, the "NO DATA" message will appear.
-

## Others

### Connecting a portable audio player to the AUX jack

---

Use a commonly available accessory cable with an RCA connector or an optional AUX105 to connect a portable audio player to the AUX (auxiliary) jack of this system.

There are 2 connection terminals on this main unit; one for the RCA connector and the other for the optional LAN cable (AUX 105). The default setting for AUX is OFF.

**1 Turn on the portable audio player and start its play function.**

The AUX mode is activated.

For details, refer to "Switching Audio Modes" on page 17.

#### ATTENTION

---

- While the AUX mode is activated, actions such as turning off the audio player or pulling out the connection cord may cause noise spikes that can damage the system speakers. Be sure to avoid this possibility by turning off system power or switching from the AUX mode to another mode before shutting off or disconnecting the portable audio player.
  - Audio output levels for the various devices that can be connected using this method will differ. Carefully adjust the volume until the output level of the connected player is known.
  - Before using a portable audio player in a vehicle, read the player's operation manual carefully and confirm problem-free operation in the vehicle before proceeding.
  - When you connect an optional LAN cable (AUX 105) to the main unit, other optional equipment that uses E-LAN cannot be connected.
- 

### Switching the AUX mode on and off

---

**1 Press the [MENU] button for more than one second.**

The Menu selection mode is activated.

**2 Select "FUNC" by pressing the [▲] or [▼] button, and then press the [ENTER] button.**

The function mode is activated.

**3 Select the AUX ON/OFF mode by pressing the [▲] or [▼] button.**

The AUX ON/OFF mode is activated.

**4 Select the ON or OFF mode by pressing the [▲] or [▼] button.**

Press the button to switch the mode as follows:

[▲]:  
ON

[▼]:  
OFF



The selected settings will take effect.

## ***Changing auxiliary input sensitivity***

The sensitivity of the auxiliary mode can be changed.

- 1** Press the [/MENU] button for more than one second.

The Menu selection mode is activated.

- 2** Select "FUNC" by pressing the [] or [] button, and then press the [ENTER] button.

The function mode is activated.

- 3** Select "AUX Sensitivity" by pressing the [] or [] button.

The AUX sensitivity mode is activated.

- 4** Select the sensitivity mode by pressing the [] or [] button.

Pressing the button allows you to toggle through sensitivity modes as follows:

Low ↔ Mid ↔ Hi ↔ Low ↔ ...

The selected settings will take effect.

## If you have a question:

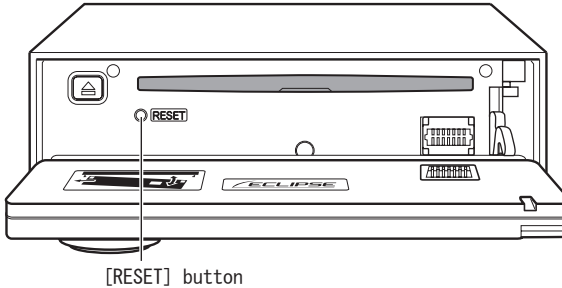

Check the items mentioned below before attempting to troubleshoot problems.

### **⚠ CAUTION**

If a problem occurs, for instance when the main unit does not respond to any button presses, or the display doesn't work correctly, press the [RESET] button using a paper clip or similar item. Pressing the [RESET] button will delete all the entries from memory. The settings will return to those made at the factory prior to shipment.

## Displayed information (for troubleshooting)

The information listed in the chart below is displayed to show the status of the CD, USB memory, XM Radio, Sirius Radio, iPod, CD changer or Bluetooth, etc. Refer to the chart for details of the appropriate remedial action to be taken.

Information		Explanation and remedial action
INFO 1	CD CHANGER SHUTTER IS OPEN	Close the shutter.
INFO 2	NO DISC IN THE MAGAZINE	There is no disc in the magazine or player. Load a disc into the magazine. (Load a music disc.)
INFO 3	DISC IS DIRTY OR DAMAGED	The loaded disc is dirty or upside down. Check its orientation and whether it is clean.
INFO 5	CD PLAYER AND CD CHANGER MECHANICAL FAILURE IS OCCURRING	<ul style="list-style-type: none"> <li>The CD player and CD changer are inoperative for some reason. Go through the magazine removal procedure.</li> <li>If the magazine fails to eject, have your dealer fix the problem.</li> <li>For the CD player, hold down the [▲] (EJECT) button for more than five seconds. If no response, contact your dealer.</li> </ul>
INFO 6	INTERNAL TEMPERATURE OF CD PLAYER AND CD CHANGER IS HIGH (PICKUP UNIT PROTECTION)	<ul style="list-style-type: none"> <li>The temperature in the CD player and CD changer is too high for operation. Wait till they cool down.</li> <li>Resume playback after the "High temperature sensed and CD stopped" display disappears. If the CD still cannot be played, have your dealer fix the problem.</li> </ul>



Information		Explanation and remedial action
LOAD		The CD changer is in the process of verifying the presence of CDs after a magazine has been inserted into the CD changer.
FILE ERR	NO VALID FILE IN CD-R OR USB MEMORY	Confirm the file.
NO SUPPORT DEVICE	USB MEMORY IS NOT SUPPORTED FORMAT	Confirm the USB memory standards.
USB ERR	PROBLEM WITH DATA TRANSMISSION	Confirm the USB memory connection.
SPS CH OFF	NO SUB CHANNEL (SPS) PROGRAM IS BROADCASTED.	Select the station that is broadcasting the desired sub channel (SPS) program.
LINKING	HD RADIO SIGNAL RECEIVING ERROR	Move to a place where a good signal can be received.
Failed	FAILED TO TRANSFER TAG INFORMATION TO iPod	Retry to connect the iPod.
CHECK ANTENNA	XM ANTENNA IS DISCONNECTED	Connect the XM antenna.
NO SIGNAL	XM Satellite RADIO SIGNAL RECEPTION FAILURE	Move to a place where a good signal can be received.
OFF AIR	NO BROADCASTING ON SELECTED CHANNEL	Select another channel.
CH UNAUTHORIZED	UNRECEIVABLE CHANNEL OR NO AVAILABLE CHANNEL IN SELECTED CATEGORY	Select another channel.
INVALID CHANNEL	NO RECEIVABLE CHANNEL	Select another channel.
ANTENNA ERROR	Sirius ANTENNA IS DISCONNECTED	Connect the Sirius antenna.
CALL 888-539-SIRIUS	NO SUBSCRIPTION TO THE SELECTED CHANNEL	Subscribe to Sirius to receive Sirius Satellite radio services.
ACQUIRING SIGNAL	Sirius Satellite RADIO SIGNAL RECEPTION FAILURE	Move to a place where a good signal can be received.
NO iPod	iPod IS NOT CONNECTED	Make sure the iPod is connected correctly.
AUTH ERROR	Authentication error	Check the iPod software.
READING...	iPod IS TRANSMITTING DATA	Wait until the message disappears before operating.
NO DATA	USB: USB CONTAINS NO DATA (MP3/WMA) TO BE READ HD Radio: TAG INFORMATION CANNOT BE USED iPod: NO MUSIC FILES STORED IN iPod	USB: Check the USB data. HD Radio: Check whether the tag indicator is displayed on the display. iPod: Check the files stored in the iPod.
ERROR1	iPod STOPS TRANSMITTING DATA FOR SOME REASON	Check the iPod connection.

## Other information

Information		Explanation and remedial action
ERROR2	iPod SOFTWARE NOT SUPPORTED	Check the iPod software.
OUTGOING ERROR	TRANSMISSION IS IMPOSSIBLE	Check whether the cell phone is connected and confirm the condition of the cell phone.
FAILED	CONNECTION ERROR/ERROR	When registering: Check whether the cell phone is Bluetooth compatible. When connecting: Check whether the cell phone has been registered in the main unit.
MEMORY FULL	NO MEMORY SPACE	Delete the phonebook data of the main unit, and then perform the registration again.

## When you think there is a malfunction

A slight difference in operation may be mistaken for a malfunction. Please check the items in the following table first.

If the unit does not work, even after the appropriate remedial action has been taken, please contact your dealer.

Mode	Problems	Causes	Remedial action	Refer to page
All	The sound is difficult to hear or cannot be heard at all.	Is the volume sufficient?	Turn up the volume.	17
		Is the muting function activated (MUTE)?	Cancel the muting (MUTE) function.	17
		Is the fader or balance control set to one side?	Readjust the fader and balance controls to normal positions.	62
		Other probable causes include broken or pinched audio-signal wires, a faulty speaker, or a detached connector.	Have your dealer check the problem.	—
	Power does not come on.	Are there too many electrical items installed, causing a lack of available power?	Have your dealer check the problem.	—
		Other probable causes include a run-down car battery, a broken fuse, or pinched or broken power or communication wires.	Have your dealer check the problem.	—
	Frequencies or titles set in memory have been deleted.	Has the car battery been disconnected for repairs or inspections?	Reenter the frequencies or titles into memory.	41
		Are there too many electrical items installed, causing a lack of available power?	Have your dealer check the problem.	—
		Other probable causes include a run-down car battery, a broken fuse, or pinched or broken power or communication wires.	Have your dealer check the problem.	—
	There is no guide tone.	Is the guide tone set to OFF?	Reset the guide tone to ON.	79
	The remote control does not work.	Are the batteries low?	Replace the batteries.	44
		Are the batteries installed correctly (reversed polarity)?	Reinstall the batteries correctly. (correct polarity.)	44
		Is direct sunlight hitting the remote control light receptor?	Use the remote control in closer proximity to the receptor.	—
		There may be a malfunction in the remote control unit.	Have your dealer check the problem.	—

Mode	Problems	Causes	Remedial action	Refer to page
CD	The disc cannot be inserted. The disc is ejected as soon as it is inserted. The disc cannot be ejected. The disc cannot be changed.	Has an extra label or sticker been applied to the disc?	Do not apply labels or stickers to the disc.	21
		Are there rough edges, deformations or damaged areas on the disc?	Try inserting another disc. Remove any burrs. Do not use deformed or damaged discs.	21
	The sound skips. The sound is intermittent. The sound quality is poor.	Is the disc damaged?	Try another disc. Do not play damaged discs.	21
		Is the disc clean?	Clean the disc.	23
		Is the player mounted at a proper angle? Is the player mounted loosely?	Have your dealer check the problem.	—
		Are you driving over a rough surface?	Avoid playback while driving over rough surfaces.	14
	The disc cannot be ejected.	If unknown	Open the front panel and press the [▲ (EJECT)] button for more than five seconds.	—
	Tuner	No stations can be received. Static noise is received	Is the antenna retracted?	Extend the antenna.
Is the tuner correctly tuned to a station?			Tune to a station.	40
Are you driving outside the service area of your preset stations?			Tune to a local station. (Please note, there may be no local stations servicing the area where you are currently driving.)	40
Are you operating other units, such as a computer or a mobile phone, in your vehicle at the same time as your main unit?			Avoid operating other units while using the main unit.	—
Other probable causes include deterioration of the antenna or broken antenna wires.			Have your authorized ECLIPSE dealer check the problem.	—

# Specifications

## <GENERAL>

Power Supply	14.4 V DC (11-16 V)
Current Drain	3 A
Dimensions (W x H x D)	
In-Dash Main unit	178 x 50 x 184.5 mm (7 x 2 x 7-1/4 inches)
Mass (weight)	Approx. 1.6 kg (3.65 lbs)
Usage temperature range	-20°C to +65°C (-4°F to +149°F )
Storage temperature range	-40°C to +85°C (-20°F to +185°F )

## <FM TUNER>

Frequency Range	
USA:	87.75 to 107.9MHz (0.2MHz step)
Asia:	87.5 to 108MHz (0.05MHz step)
Australia:	87.5 to 108MHz (0.1MHz step)
Latin America:	87.9 to 108MHz (0.1MHz step)
Usable Sensitivity	15 dBf
Frequency Response	30 to 15,000 Hz, ± 3 dB
Stereo Separation	38 dB (1 kHz)

## <AM TUNER>

Frequency Range	
USA:	530 to 1,710kHz (10kHz step)
Asia:	522 to 1,629kHz (9kHz step)
Australia:	522 to 1,710kHz (9kHz step)
Latin America:	530 to 1,710kHz (10kHz step)
Usable Sensitivity	22µV

## <CD SECTION>

Frequency Response	20 Hz to 20 kHz, ±3 dB
Wow & Flutter	Below measurable limits
Stereo Separation	80dB
S/N Ratio (A-weighted)	85dB
Dynamic Range	85dB
Total Harmonic Distortion	0.008%

## <USB MEMORY SECTION>

Frequency Response	20 Hz to 20 kHz, ±3 dB
S/N Ratio (A-weighted)	95dB
Total Harmonic Distortion	0.008 %

<Bluetooth Audio>

Bluetooth Specification  
Power Output  
Profile

Bluetooth Specification Ver.2.0  
Power class 2 (Max +4 dBm)  
A2DP Ver.1.0  
AVRCP Ver.1.0

<Bluetooth Hands-free>

Bluetooth Specification  
Power Output  
Profile

Bluetooth Specification Ver.2.0  
Power class 2 (Max +4 dBm)  
HFP Ver.1.5  
OPP Ver.1.1

<AUDIO AMPLIFIER>

Power Output  
  
Output Level/Impedance  
Loudness

25W x 4 (10% THD, 4Ω, Vcc=16.0V)  
Max. 50 W x 4  
5 V/55Ω line-out impedance  
+7dB at 50Hz/+5dB at 10kHz

# How to contact customer service

Should the product require service, please contact the following ECLIPSE dealer near you.

## <U.S.A/CANADA>

Fujitsu Ten Corp. of America  
19600 South Vermont Avenue, Torrance, CA 90502  
Phone: 1-800-233-2216 (Information)

## <AUSTRALIA>

Fujitsu Ten (Australia) PTY LTD.  
89 Cook Street Port Melbourne, Victoria 3207 Australia  
Phone: 1800 211 411  
Fax: 03 9646 8084

## <MALAYSIA>

CSE Automotive Technologies Sdn. Bhd.  
Level 5, Axis Plaza, Jalan U1/44, Glenmarie, 40150 Shah Alam,  
Selangor D.E., Malaysia  
Phone: 03-5569-4200  
Fax: 03-5569-4201

## <SINGAPORE>

Cobra Singapore Pte Ltd  
#07-07 HB Centre1 12 Tannery Road, Singapore 347722  
Phone: 6737 2568  
Fax: 6737 9538

## <KOREA>

J & TED TRADE  
Toy Bldg 2F, 1815 San Kyuk 2 Dong, Buk Gu, Daegu, Korea  
Phone: (053) 382-8248  
Fax: (053) 382-8249

## <TAIWAN>

Sentrek Taiwan, LTD.  
1, 9F, Lane 155, Section 3, Peishen RD., Shenkeng, Taipei Hsien, 222  
Taiwan, R.O.C.  
Phone: 02-2662-8110  
Fax: 02-2662-8117

## <INDONESIA>

PT. Anugrah Valova Electrindo.  
Jl.Bukit Gading Raya Blok P 21-22, Kelepa Gading Barat, Jakarta 14240  
Phone: (021) 4585-2857  
Fax: (021) 4586-5710

# **IMPORTANT**

**RECORD YOUR “KEY CD  
(SECURITY CODE)”  
HERE...**

---

---

---

**STORE YOUR “KEY CD  
(SECURITY CODE)” ALONG  
WITH YOUR OWNER'S  
MANUAL.**



