

## CDBA220-G Thru. CDBA2100-G

Reverse Voltage: 20 to 100 Volts

Forward Current: 2.0 Amp

RoHS Device

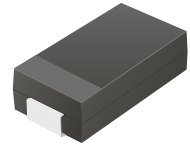

### Features

- Ideal for surface mount applications.
- Easy pick and place.
- Plastic package has Underwriters Lab. flammability classification 94V-0.
- Built-in strain relief.
- Low forward voltage drop.

### Mechanical data

- Case: JEDEC DO-214AC, molded plastic.
- Terminals: solderable per MIL-STD-750, method 2026.
- Polarity: Color band denotes cathode end.
- Approx. weight: 0.064 grams

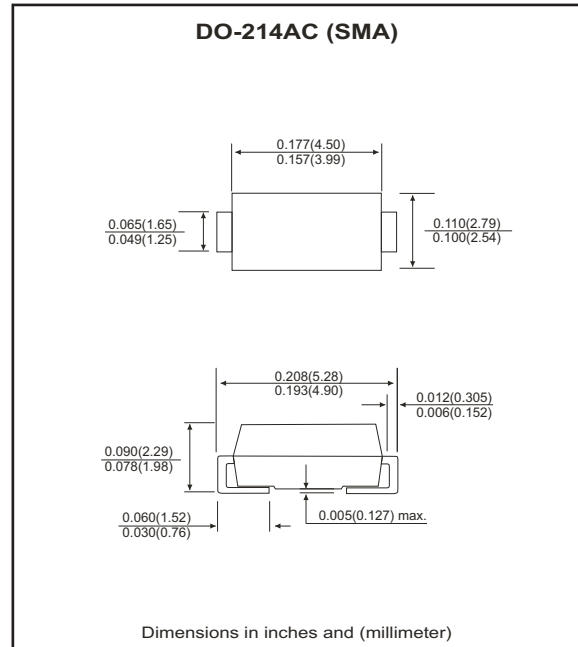

### Maximum Ratings and Electrical Characteristics

Parameter	Symbol	CDBA 220-G	CDBA 240-G	CDBA 260-G	CDBA 280-G	CDBA 2100-G	Units	
Max. repetitive peak reverse voltage	$V_{RRM}$	20	40	60	80	100	V	
Max. DC blocking voltage	$V_{DC}$	20	40	60	80	100	V	
Max. RMS voltage	$V_{RMS}$	14	28	42	56	70	V	
Peak surge forward current, 8.3ms single half sine-wave superimposed on rate load (JEDEC method)	$I_{FSM}$	50						A
Max. average forward current	$I_o$	2.0						A
Max. instantaneous forward voltage at 2.0A	$V_F$	0.50		0.70	0.85		V	
Max. DC reverse current at $T_A=25\text{ }^\circ\text{C}$ rated DC blocking voltage $T_A=100\text{ }^\circ\text{C}$	$I_R$	0.5			10		mA	
Max. thermal resistance (Note 1)	$R_{\theta JA}$ $R_{\theta JL}$	75			17		$^\circ\text{C/W}$	
Max. operating junction temperature	$T_J$	125					$^\circ\text{C}$	
Storage temperature	$T_{STG}$	-65 to +150					$^\circ\text{C}$	

Notes: 1. Thermal resistance from junction to ambient and junction to lead mounted on P.C.B. with 5.0x5.0 mm copper pad area.

## RATING AND CHARACTERISTIC CURVES (CDBA220-G thru CDBA2100-G)

Fig.1 Reverse Characteristics

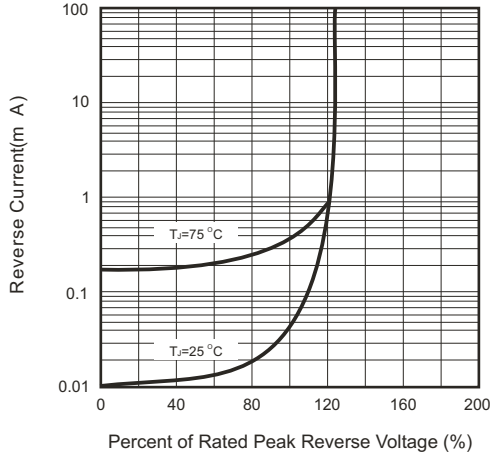

Fig.2 Forward Characteristics

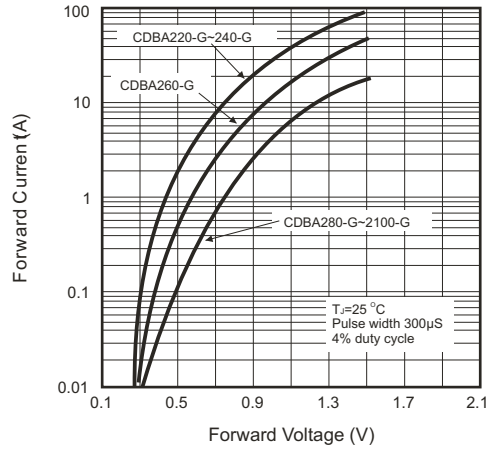

Fig.3 Junction Capacitance

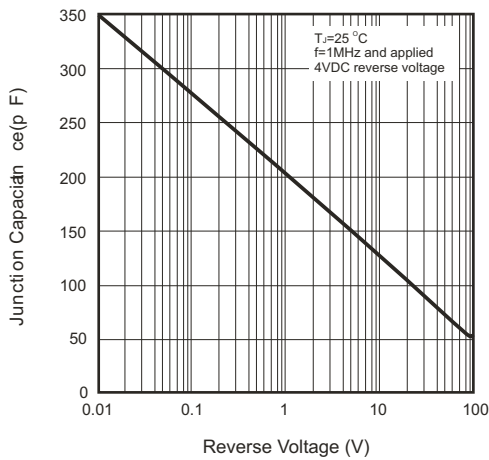

Fig.4 Current Derating Curve

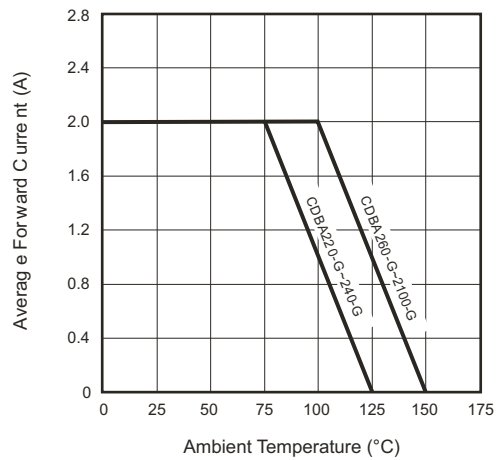
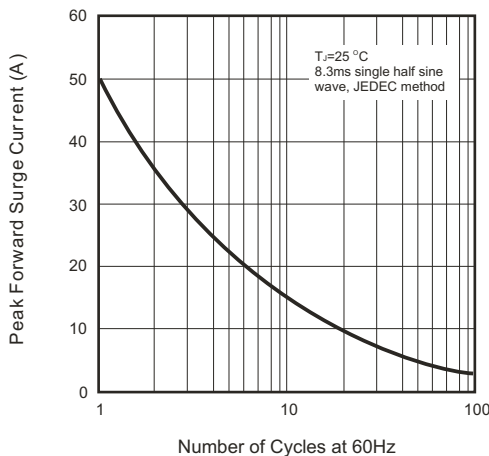
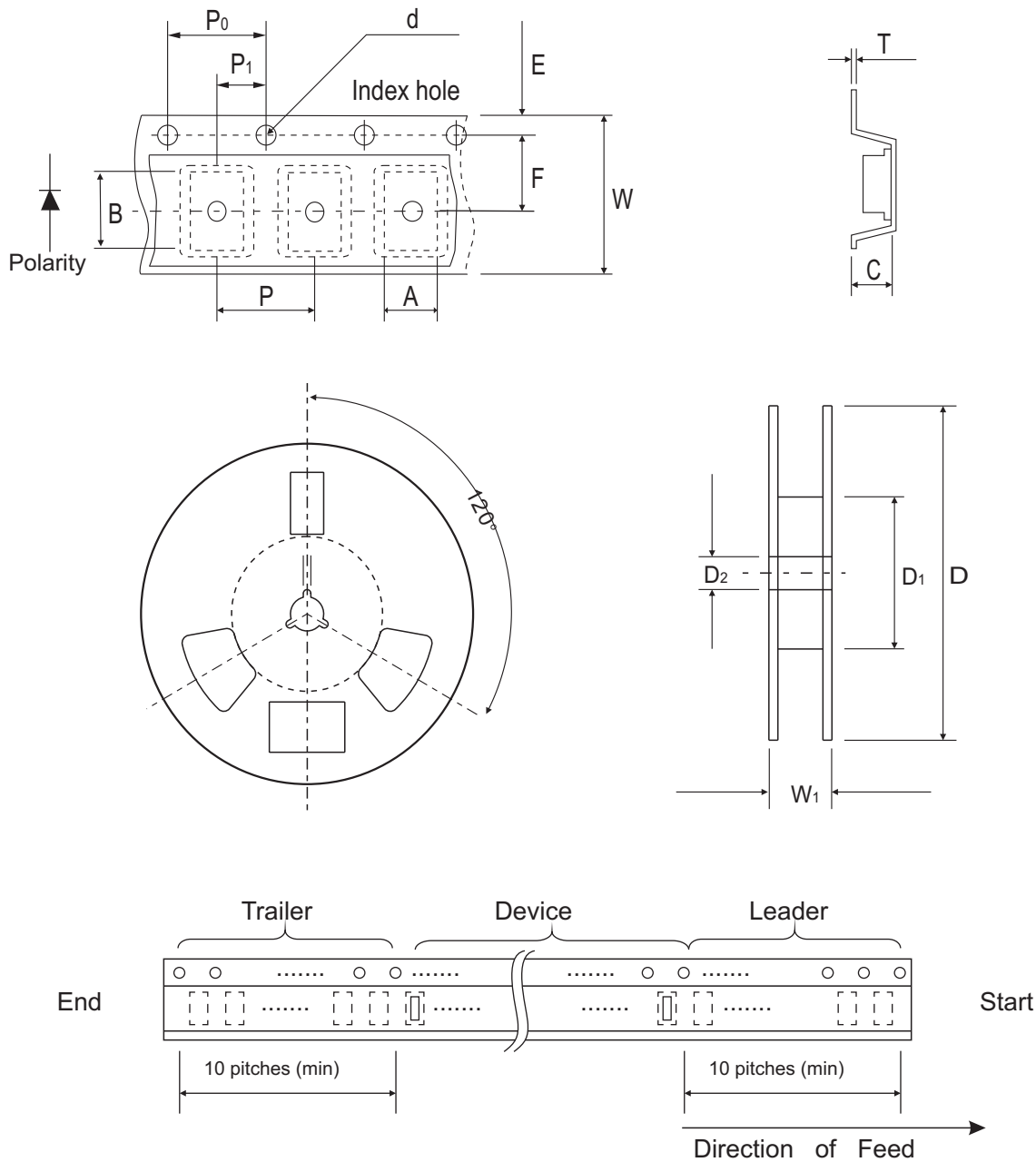

Fig.5 Non-repetitive Forward Surge Current



## Reel Taping Specification



DO-214AC (SMA)	SYMBOL	A	B	C	d	D	D1	D2
	(mm)	2.7 Max	5.3 Max	2.66 Max	1.50 ± 0.10 DIA	330 ± 2.00	50.0 Min.	13.5 ± 1.00
	(inch)	0.106 Max	0.209 Max	0.105 Max	0.059 ± 0.004 DIA	13.00 ± 0.079	1.969 Min.	0.531 ± 0.039

DO-214AC (SMA)	SYMBOL	E	F	P	P0	P1	W	W1
	(mm)	1.75 ± 0.10	5.50 ± 0.05	4.00 ± 0.10	4.00 ± 0.10	2.00 ± 0.05	12.0 ± 0.30	18.4 Max.
	(inch)	0.689 ± 0.004	0.216 ± 0.002	0.157 ± 0.004	0.157 ± 0.004	0.079 ± 0.002	0.472 ± 0.012	0.724 Max

## Marking Code

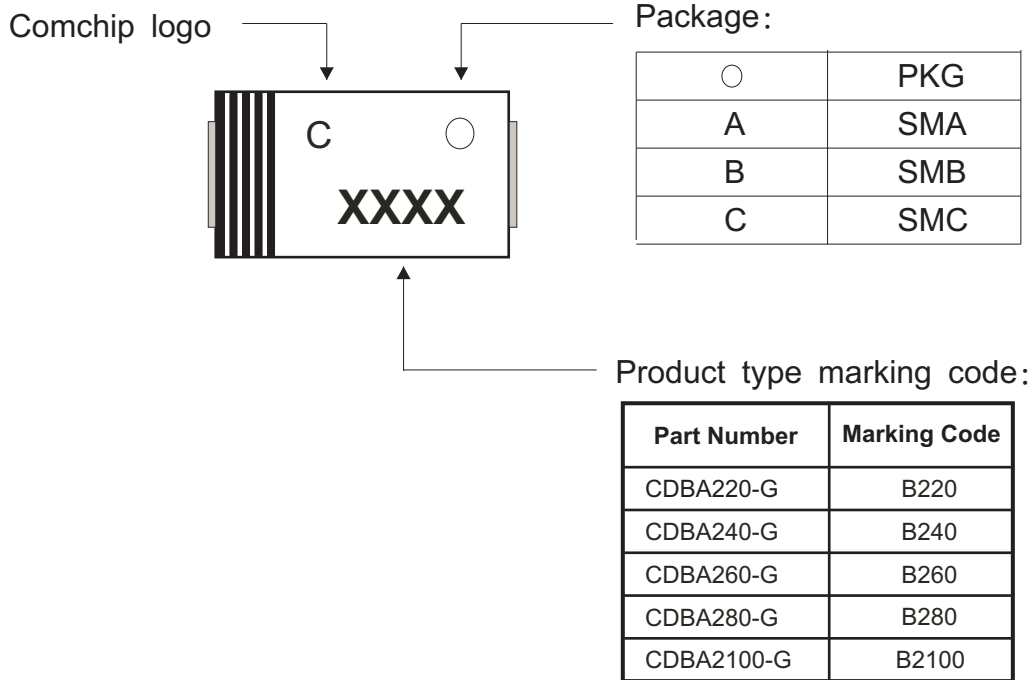

## Suggested PAD Layout

SIZE	DO-214AC(SMA)	
	(mm)	(inch)
A	3.80	0.150
B	1.60	0.063
C	2.80	0.110
D	5.40	0.213
E	2.20	0.087

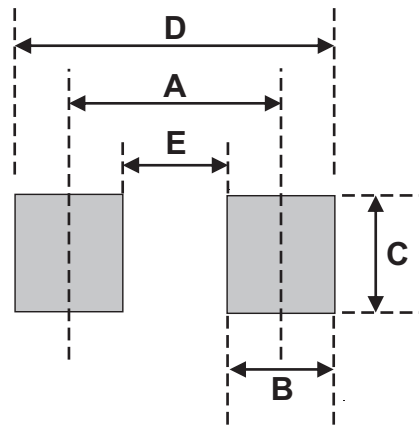

## Standard Packaging

Case Type	REEL PACK	
	REEL ( pcs )	Reel Size (inch)
DO-214AC (SMA)	5,000	13