

CDBN0230

$I_o = 200 \text{ mA}$
 $V_R = 30 \text{ Volts}$

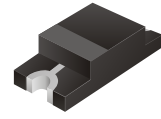

Features

- Designed for mounting on small surface
- Extremely thin package
- Low stored charge
- Majority carrier conduction

Mechanical data

Case: 1206(3216) Standard package, molded plastic.

Terminals: Solder plated, solderable per MIL-STD-750, method 2026.

Polarity: Indicated by cathode band.

Mounting position: Any.

Weight: 0.0085 gram. (approximately)

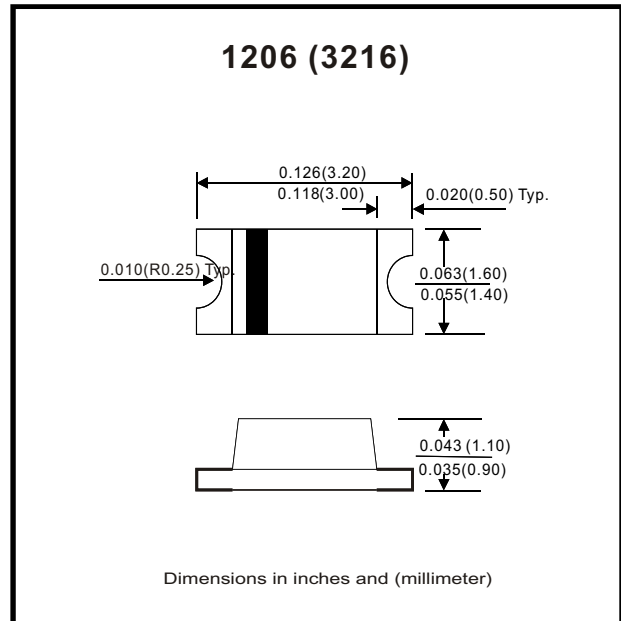

Maximum Rating (at $T_A = 25^\circ\text{C}$ unless otherwise noted)

Parameter	Conditions	Symbol	Min	Typ	Max	Unit
Repetitive peak reverse voltage		V_{RRM}			35	V
Reverse voltage		V_R			30	V
Average forward current		I_o			200	mA
Forward current , surge peak	8.3 ms single half sine-wave superimposed on rate load(JEDEC method)	I_{FSM}		3000		mA
Power Dissipation		P_D			250	mW
Storage temperature		T_{STG}	-40		+125	$^\circ\text{C}$
Junction temperature		T_j	-40		+125	$^\circ\text{C}$

Electrical Characteristics (at $T_A = 25^\circ\text{C}$ unless otherwise noted)

Parameter	Conditions	Symbol	Min	Typ	Max	Unit
Forward voltage	$I_F = 200 \text{ mA DC}$	V_F			0.50	V
Reverse current	$V_R = 30 \text{ V}$	I_R			30	μA
Capacitance between terminals	$f = 1 \text{ MHz}$, and 10 VDC reverse voltage	C_T		10		pF

RATING AND CHARACTERISTIC CURVES (CDBN0230)

Fig. 1 - Forward characteristics

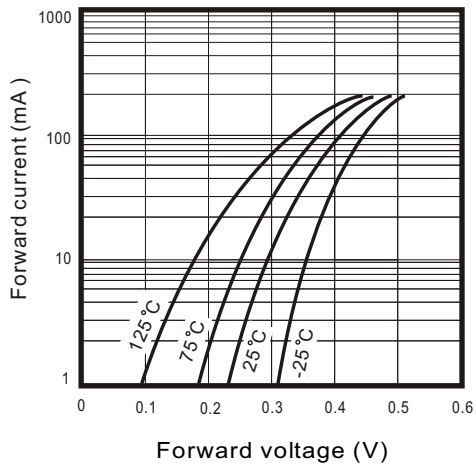

Fig. 2 - Reverse characteristics

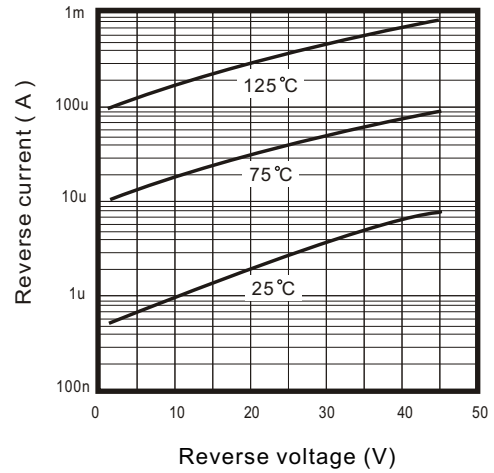

Fig. 3 - Capacitance between terminals characteristics

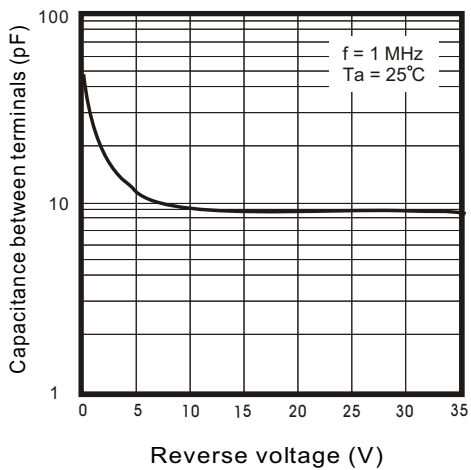

Fig. 4 - Current derating curve

