

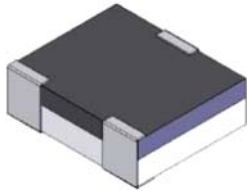

Small Signal Switching Diode, SOT323 Case

CDBAV99W/ CDBAV70W/ CDBAW56W/ CDMMBD4148W



FEATURES

- Silicon epitaxial planar diode
- SMD chip pattern, SOT323 case, available also in SOT23 case
- Leadfree and RoHS compliance components
- For small signal switching and operating ambient temperature less than 55°C and voltage withstand less than 60V; not suitable for AC switching input as rectified circuit and high reverse voltage location.

MECHANICAL CHARACTERISTICS

- Size: SOT323 case
- Weight: approx. 11mg
- Marking: BAV99 as anode to cathode series dual switching diode
BAV70 as common cathode dual switching diode
BAW56 as common anode dual switching diode
BD4148 as SOT323 case single switching diode

GRAPHIC SYMBOL

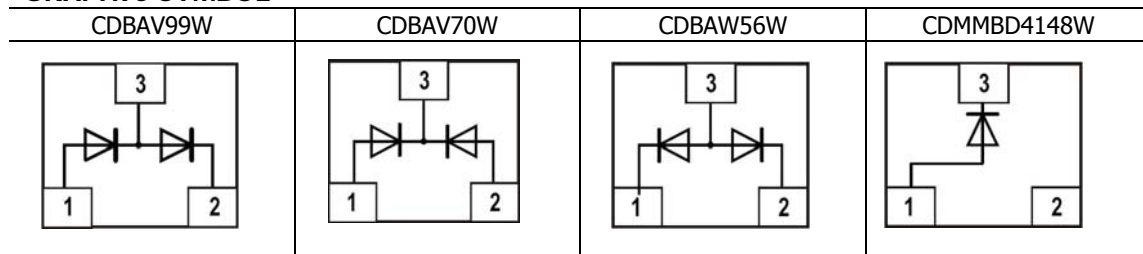

DIMENSIONS

Dimension/mm	SOT323
L	2.0±0.2
W	2.1±0.2
T	0.85±0.1
C	0.55±0.2

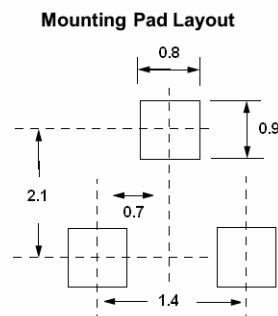
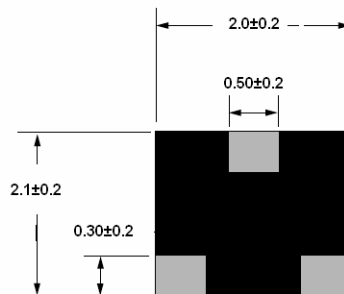
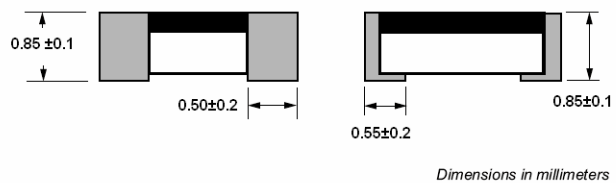

**THERMAL CHARACTERISTICS¹⁾**

Parameter at $T_{amb}=25^{\circ}\text{C}^{1)}$	Symbol	Value	Unit
Forward Power Dissipation Power derating above 25°C	P_{tot}	200	mW
		1.6	mW/°C
Junction Temperature	T_j	150	°C
Thermal Resistance Junction to Ambient air	$R_{\theta JA}$	625	°C/W
Operating & Storage Temperature range	T_{stg}	-55 to 150	°C

1) Valid provided that electrodes are kept at ambient temperature.

MAXIMUM RATING¹⁾

Parameter at $T_{amb}=25^{\circ}\text{C}^{1)}$	Symbol	Value	Unit
Repetitive Peak Reverse Voltage	V_{RRM}	75	V
Average rectified current sin half wave rectification with resistive load	$I_{F(AV)}$	150 ²⁾	mA
		130 ³⁾	mA
Repetitive Peak Forward Current at $T_{amb}=25^{\circ}\text{C}$	I_{FRM}	200	mA
Non-Repetitive Surge Forward Current at $t < 1\text{s}$ and $T_j=25^{\circ}\text{C}$ at $t \leq 8.3\text{ms}$ and $T_j=25^{\circ}\text{C}$	I_{FSM}	500	mA
		1000	mA

1) Valid provided that electrodes are kept at ambient temperature.

2) Single diode

3) Double diode

ELECTRICAL CHARACTERISTICS¹⁾

Parameter at $T_{amb}=25^{\circ}\text{C}^{1)}$	Symbol	Value	Unit
Forward Voltage at $I_F=10\text{mA}$ at $I_F=50\text{mA}$ at $I_F=100\text{mA}$	V_F	0.855 _{MAX}	V
		1.0 _{MAX}	V
		1.25 _{MAX}	V
Leakage Current at $V_R=75\text{V}$	I_R	2.5 _{MAX}	uA
Capacitance at $V_R=0\text{V}, f=1\text{MHz}$	C_{tot}	4 _{MAX}	pF
Reverse Recovery Time at $I_F=I_R=10\text{mA}, R_L=100\Omega$	t_{rr}	6 _{MAX}	ns

1) Valid provided that electrodes are kept at ambient temperature.



TYPICAL CHARACTERISTICS

Figure 1. Forward Characteristic

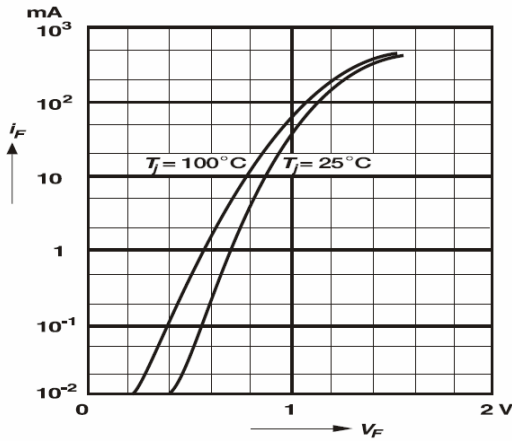

Figure 2. Power De-rating

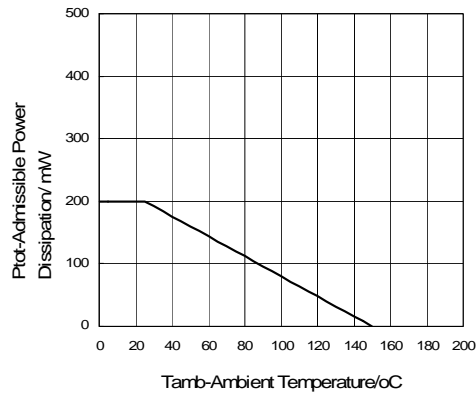

Figure 3. Forward Current De-rating

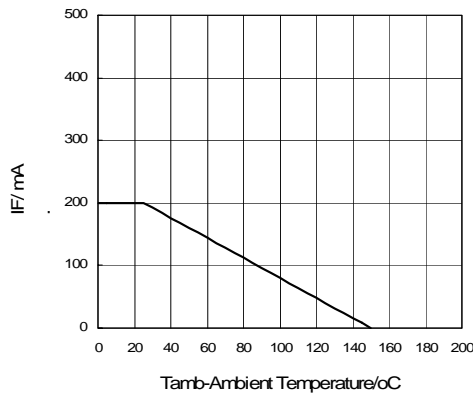
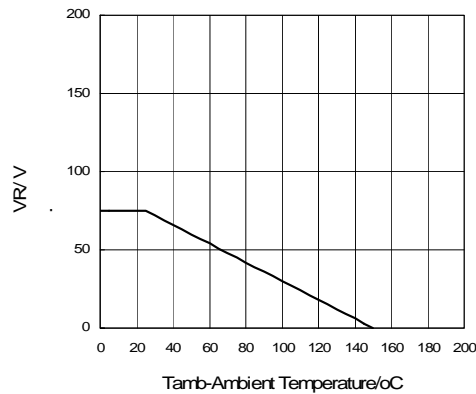

Figure 4. Reverse Voltage De-rating



TEST CHARACTERISTICS

Test Item	Test Condition	Requirement
Solderability	Sn bath at $245 \pm 5^\circ\text{C}$ for $2 \pm 0.5\text{s}$	>95% area tin covered
Resistance to Soldering Heat	Sn bath at $260 \pm 5^\circ\text{C}$ for $10 \pm 2\text{s}$	V_F, V_R & I_R within spec; no mechanical damage
Humidity Steady State	At 85°C 85%RH for 168hrs	V_F, V_R & I_R within spec
Continue Forward Operating Life	At 25°C $I_F = 1.1 I_{F\text{max}}$ for 1000hrs	V_F, V_R & I_R within spec
Thermal Shock	$-55 \pm 5^\circ\text{C}/5\text{min}$ to $150 \pm 5^\circ\text{C}/5\text{min}$ for 10cycles	V_F, V_R & I_R within spec
Bending Strength	Bending up to 2mm for 1cycle	V_F, V_R & I_R within spec; no mechanical damage



APPLICATIONS

- Function: suit for small signal switching application
- Typical Application circuit:

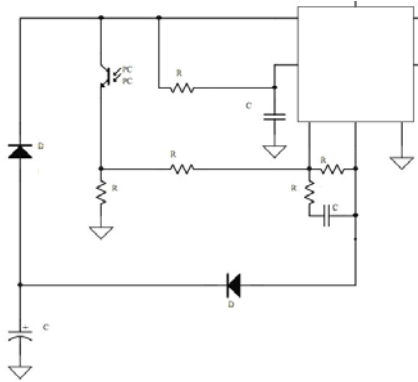

- Typical Product field: General application except high reverse voltage location

- Soldering Condition:

Soldering Condition & Caution

- Recommended Soldering Condition
(Refer to IPC/JEDEC J-STD-020D 4-1&5.2)

Recommended Profile Condition	Sn-Pb Soldering	Leadfree Soldering	Wave Soldering
Ramp-up rate (from pre-heat stage)	<3°C/s	<3°C/s	ΔT<150°C
Pre-heat Temperature & Time	100-150 °C 60-120s	150-200 °C 60-120s	100-150 °C 60-120s
Soldering Temperature & Time	183 °C 60-150s	217 °C 60-150s	260±5°C 5±2s
Peak Temperature	230±5°C <260°C	245±5°C <260°C	260±5°C
Time within 5°C of peak temperature	10-20s	20-30s	-
Ramp-down rate	<6°C/s	<6°C/s	<6°C/s
Time 25°C to peak temperature	<6min	<8min	-

Manual Soldering: Approx. 350°C for 3s, avoid solder iron tip direct touch the components body



Recommended Soldering Profile

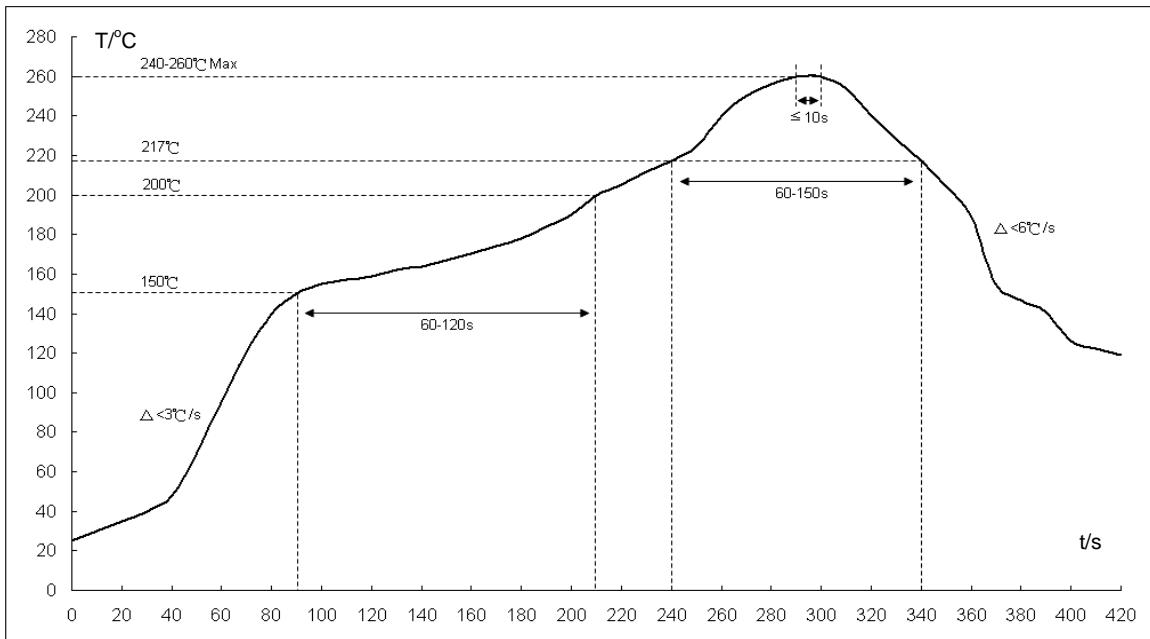

Fig1: Reflow soldering profile for lead-free solder (SnAgCu)

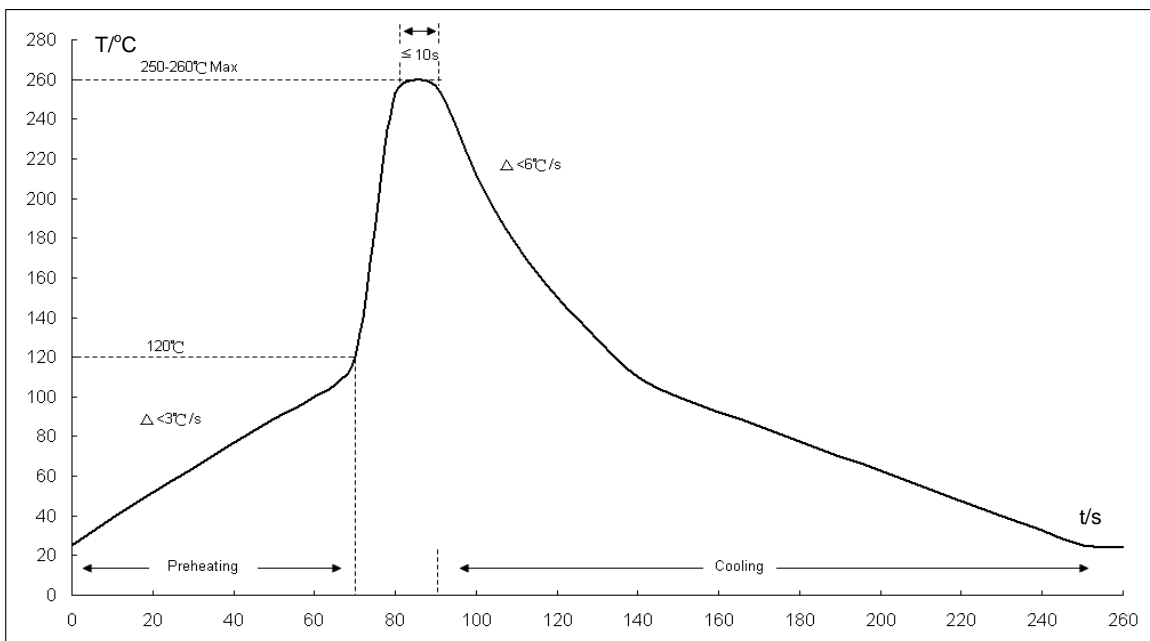

Fig2: Wave soldering profile

- *1. The recommended profiles are referring to IPC/JEDEC J-STD-020D & IEC-60068-2-58
- *2. Chip diodes are able to stand maximum soldering temperature up to 260°C max for 10s, and the soldering cycles with max 3 times, referring to IEC-60068-2-58



- Storage Condition: Product termination solderability can degrade due to high temperature and humidity or chemical environment. Storage condition must be in an ambient temperature of <40°C and ambient humidity of <75%RH, and free from chemical.

ENVIRONMENTAL CHARACTERISTICS

Product	Hazardous Substance or Element/ppm					
	Pb	Cd	Hg	Cr ⁶⁺	PBB	PBDE
	<1000	<100	<1000	<1000	<1000	<1000

Product	Halogen Substance/ ppm				
	F	Cl	Br	I	Total
	<900	<900	<900	<900	<1500

PACKING METHOD

Product	Quantity/Reel	Reel Size	Tape
	5,000pcs	7"	Paper tape

DISCLAIMERS

These products are not designed for use in applications where any failure or malfunction may result in personal injury, death or severe property or environmental damage such as medical, military, aircraft, space or life support equipments.