

Features

- RoHS compliant*
- ESD protection >25 kV
- Protects six unidirectional lines
- Protects five bidirectional lines

Applications

- Sensor electronics
- Portable electronics
- RS232, RS422 and RS423 data lines

CDNBS08-SMDA05-6 - Std. Capacitance TVS Diode Arrays

General Information

The CDNBS08-SMDA05-6 series provides ESD, EFT and Surge protection for external ports meeting IEC 61000-4-2 (ESD), IEC 61000-4-4 (EFT) and IEC 61000-4-5 (Surge) requirements.

The Transient Voltage Suppressor offers a Working Peak Reverse Voltage from 5 V and Minimum Breakdown Voltage range of 6 V. The device can protect six unidirectional lines or five bidirectional lines, available in a JEDEC SO-8 package and intended to be mounted directly onto an FR4 printed circuit board.

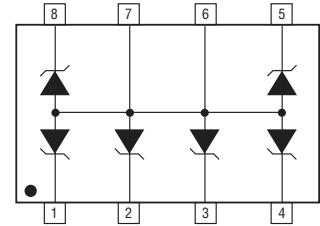

Absolute Maximum Ratings (@ T_A = 25 °C Unless Otherwise Noted)

Parameter	Symbol	Value	Unit
Peak Pulse Power (tp = 8/20 μs) ¹	P _{PK}	350	W
Storage Temperature	T _{STG}	-55 to +150	°C
Operating Temperature	T _{OPR}	-55 to +150	°C

Notes:

1. See Peak Pulse Power vs. Pulse Time.

Electrical Characteristics (@ T_A = 25 °C Unless Otherwise Noted)

Parameter	Symbol	Value	Unit
Minimum Breakdown Voltage @ 1 mA	V _{BR}	6.0	V
Maximum Working Peak Voltage	V _{WM}	5.0	V
Maximum Leakage Current @ V _{WM}	I _D	20	μA
Maximum Clamping Voltage @ I _P = 1 A	V _C	9.8	V
Maximum Clamping Voltage @ I _{PP} = 17 A	V _C	18	V
Maximum Junction Capacitance @ 0 V, 1 MHz	C _J	120	pF
ESD Protection per IEC 61000-4-2 Minimum Contact Discharge Minimum Air Discharge	ESD	± 8 ±15	kV
EFT Protection per IEC 61000-4-4 @ 5/50 ns	EFT	40	A
Surge Protection per IEC 61000-4-5 @ 8/20 μs Level 1 (Line-Gnd) & Level 2 (Line-Line)		12	A

Notes:

1. Test from individual pins 1, 2, 3, 4, 5 and 8 to ground pins 6 and 7 (unidirectional only).
2. Pins 6 & 7 not connected for bidirectional use.

CDNBS08-SMDA05-6 - Std. Capacitance TVS Diode Arrays



Product Dimensions

This is an RoHS compliant molded JEDEC SO-8 package with 100 % Sn plating on the terminations. It weighs approximately 70 mg and has a flammability rating of UL 94V-0.

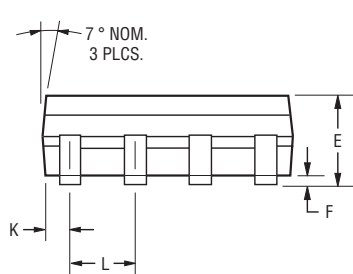
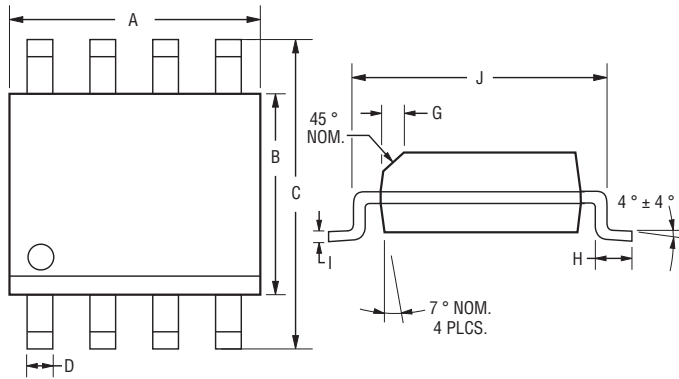

DIMENSIONS = $\frac{\text{MILLIMETERS}}{\text{(INCHES)}}$

Dimensions	
A	$\frac{4.80 - 5.00}{(0.189 - 0.197)}$
B	$\frac{3.81 - 4.00}{(0.150 - 0.157)}$
C	$\frac{5.80 - 6.20}{(0.228 \pm 0.244)}$
D	$\frac{0.36 - 0.51}{(0.014 - 0.020)}$
E	$\frac{1.35 - 1.75}{(0.053 - 0.069)}$
F	$\frac{0.102 - 0.203}{(0.004 - 0.008)}$
G	$\frac{0.25 - 0.50}{(0.010 - 0.020)}$
H	$\frac{0.51 - 1.12}{(0.020 - 0.044)}$
I	$\frac{0.190 - 0.229}{(0.0075 - 0.0090)}$
J	$\frac{4.60 - 5.21}{(0.181 - 0.205)}$
K	$\frac{0.28 - 0.79}{(0.011 - 0.031)}$
L	$\frac{1.27}{(0.050)}$

Recommended Footprint

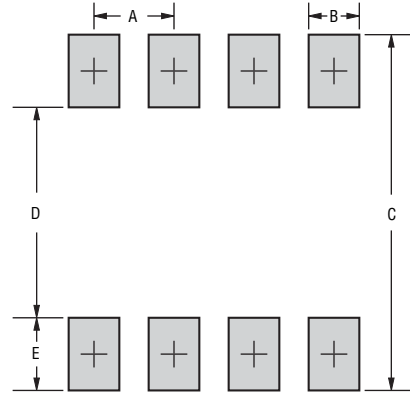

Dimensions	
A	$\frac{1.143 - 1.397}{(0.045 - 0.065)}$
B	$\frac{0.635 - 0.889}{(0.025 - 0.035)}$
C	$\frac{6.223}{(0.245)}$ Min.
D	$\frac{3.937 - 4.191}{(0.155 - 0.165)}$
E	$\frac{1.016 - 1.27}{(0.040 - 0.050)}$

Typical Part Marking

CDNBS08-SMDA-05-6 QEB

How to Order

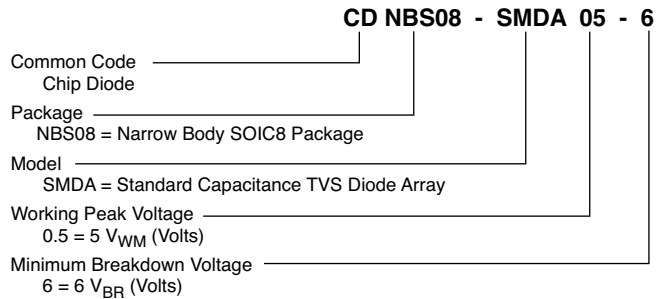

Specifications are subject to change without notice.
 Customers should verify actual device performance in their specific applications.

CDNBS08-SMDA05-6 - Std. Capacitance TVS Diode Arrays

Performance Graphs

Peak Pulse Power vs Pulse Time

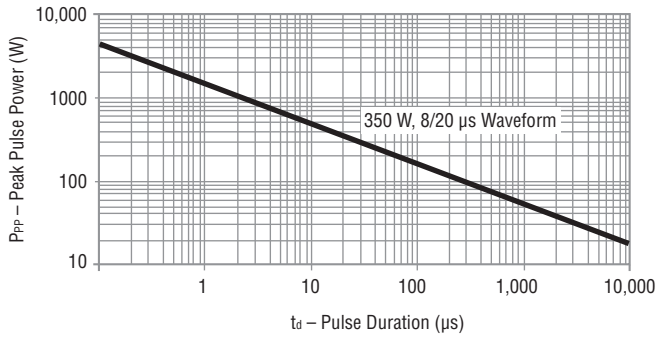

Pulse Waveform

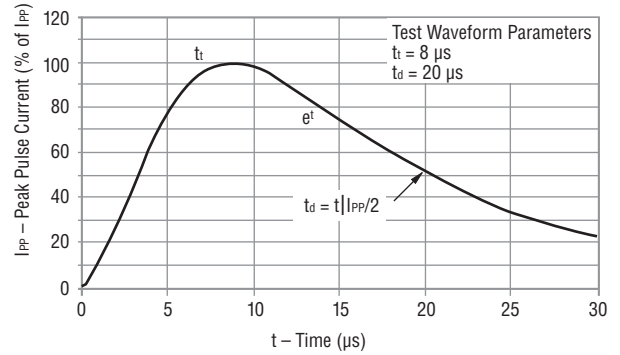

CDNBS08-T05L ESD Pulse Response

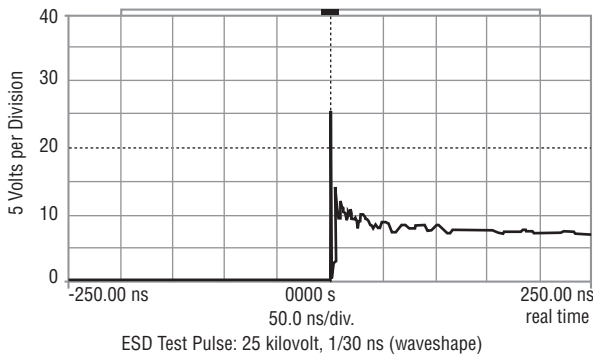

Power Derating Curve

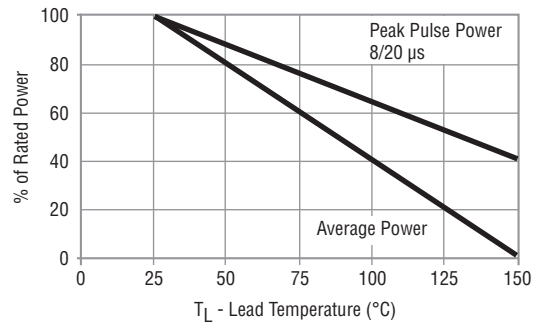

CDNBS08-SMDA05-6 - Std. Capacitance TVS Diode Arrays

BOURNS®

Packaging Information

The product is packaged in tape and reel format per EIA-481 standard.

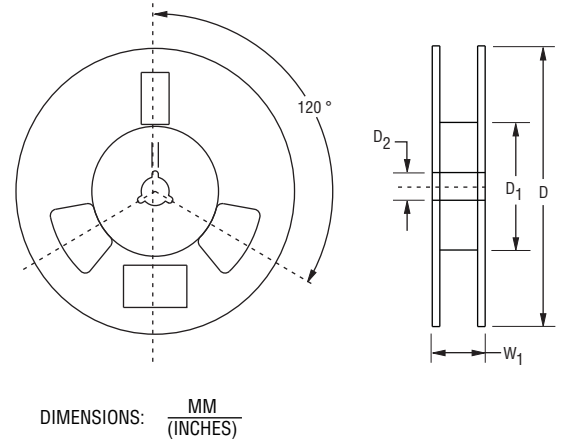
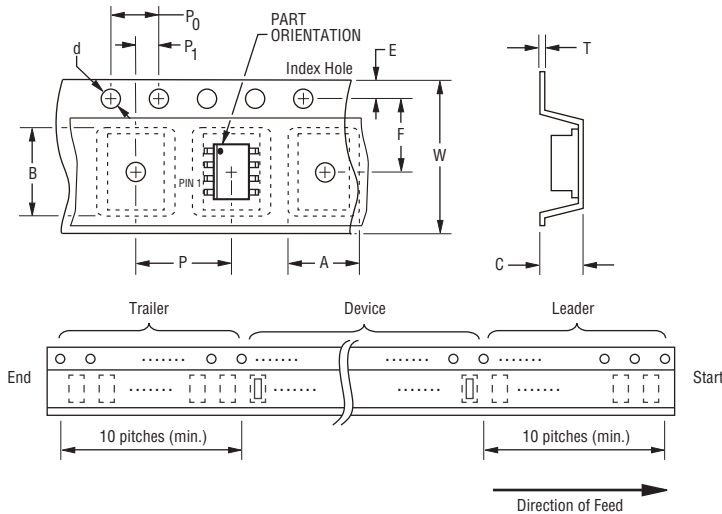

DIMENSIONS: $\frac{\text{MM}}{\text{(INCHES)}}$

Item	Symbol	NSOIC 8L
Carrier Width	A	$\frac{6.7 \pm 0.10}{(0.264 \pm 0.004)}$
Carrier Length	B	$\frac{5.5 \pm 0.10}{(0.217 \pm 0.004)}$
Carrier Depth	C	$\frac{2.10 \pm 0.10}{(0.083 \pm 0.004)}$
Sprocket Hole	d	$\frac{1.55 \pm 0.05}{(0.061 \pm 0.002)}$
Reel Outside Diameter	D	$\frac{330}{(12.992)}$
Reel Inner Diameter	D ₁	$\frac{80.0}{(3.1500)}$ MIN.
Feed Hole Diameter	D ₂	$\frac{13.0 \pm 0.20}{(0.512 \pm 0.008)}$
Sprocket Hole Position	E	$\frac{1.75 \pm 0.10}{(0.069 \pm 0.004)}$
Punch Hole Position	F	$\frac{3.50 \pm 0.05}{(0.138 \pm 0.002)}$
Punch Hole Pitch	P	$\frac{8.00 \pm 0.10}{(0.315 \pm 0.004)}$
Sprocket Hole Pitch	P ₀	$\frac{4.00 \pm 0.10}{(0.157 \pm 0.004)}$
Embossment Center	P ₁	$\frac{2.00 \pm 0.05}{(0.079 \pm 0.002)}$
Overall Tape Thickness	T	$\frac{0.20 \pm 0.10}{(0.008 \pm 0.004)}$
Tape Width	W	$\frac{12.00 \pm 0.20}{(0.472 \pm 0.008)}$
Reel Width	W ₁	$\frac{18.4}{(0.724)}$ MAX.
Quantity per Reel	--	2500

BOURNS®

Asia-Pacific:

Tel: +886-2 2562-4117

Fax: +886-2 2562-4116

Europe:

Tel: +41-41 768 5555

Fax: +41-41 768 5510

The Americas:

Tel: +1-951 781-5500

Fax: +1-951 781-5700

www.bourns.com

REV. 12/12

Specifications are subject to change without notice.
Customers should verify actual device performance in their specific applications.