

SMD Power Inductor CDRH129R

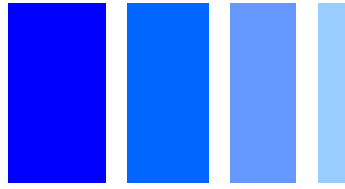

**Halogen
Free**



Description

- Ferrite drum core construction.
- Magnetically shielded.
- L × W × H: 12.4 × 12.4 × 10.0 mm Max.
- Product weight: 5.3g(Ref.)
- Moisture Sensitivity Level: 1
- RoHS compliance.
- Halogen Free available.

Dimension - [mm]

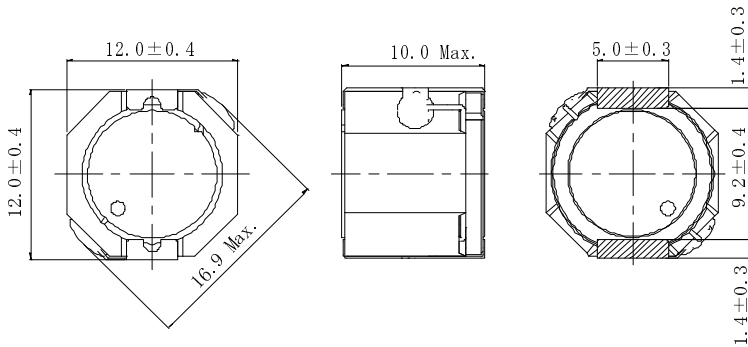

Land pattern and Schematics - [mm]

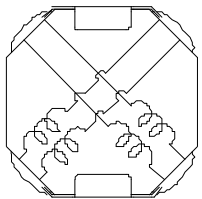
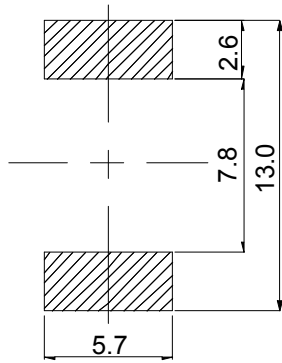

10 μH ~ 56 μH

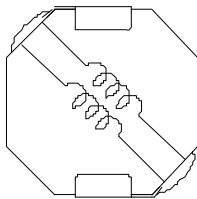

68 μH ~ 330 μH

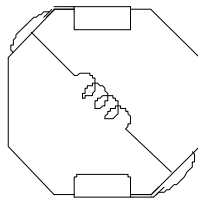

470 μH ~ 1.0mH

Environmental Data

- Operating temperature range: -40°C ~ +125°C (including coil's self temperature rise)
- Storage temperature range: -40°C ~ +125°C
- Solder reflow temperature: 260 °C peak.

Packaging

- Carrier tape and reel packaging.
- 13" diameter reel.
- 250pcs per reel.

Applications

- Ideally used in LED lighting, etc.

SMD Power Inductor CDRH129R



Electrical Characteristics

Part No.	Stamp	Inductance (μ H) 100kHz [Within]	D.C.R.(m Ω) [Max] (at 20°C)※1	Saturation current (A) (at20°C)※2	Temperature rise current (A) ※3
CDRH129RNP-100MC	100	10 \pm 20%	16.5(13.2)	7.60	6.50
CDRH129RNP-150MC	150	15 \pm 20%	20.3(16.2)	5.80	6.00
CDRH129RNP-220MC	220	22 \pm 20%	32.9(26.3)	5.30	4.70
CDRH129RNP-330MC	330	33 \pm 20%	39.3(31.4)	4.00	4.25
CDRH129RNP-470MC	470	47 \pm 20%	53.4(42.7)	3.45	3.80
CDRH129RNP-560MC	560	56 \pm 20%	67.0(53.6)	3.15	3.25
CDRH129RNP-680MC	680	68 \pm 20%	83.5(66.8)	2.95	2.85
CDRH129RNP-820MC	820	82 \pm 20%	90.6(72.5)	2.60	2.75
CDRH129RNP-101MC	101	100 \pm 20%	116(93)	2.40	2.45
CDRH129RNP-151MC	151	150 \pm 20%	159(127)	1.95	2.20
CDRH129RNP-221MC	221	220 \pm 20%	226(181)	1.60	1.85
CDRH129RNP-331MC	331	330 \pm 20%	366(293)	1.30	1.45
CDRH129RNP-471MC	471	470 \pm 20%	415(330)	1.08	1.30
CDRH129RNP-561MC	561	560 \pm 20%	521(417)	1.00	1.18
CDRH129RNP-681MC	681	680 \pm 20%	654(523)	0.91	1.04
CDRH129RNP-821MC	821	820 \pm 20%	825(660)	0.82	0.92
CDRH129RNP-102MC	102	1000 \pm 20%	938(750)	0.75	0.82

※1 () are typical value.

※2 The saturation current: This indicates the value of DC current when the inductance decreases to 75% of its nominal.

※3 The temperature rise: The value of DC current when the temperature rise is $\Delta T=40^{\circ}\text{C}$ ($T_a=20^{\circ}\text{C}$).

SMD Power Inductor CDRH129R

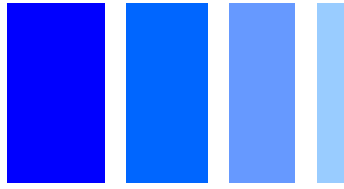

Saturation Current & Temperature Rise Graph

— L (20°C) — L (105°C) — ΔT

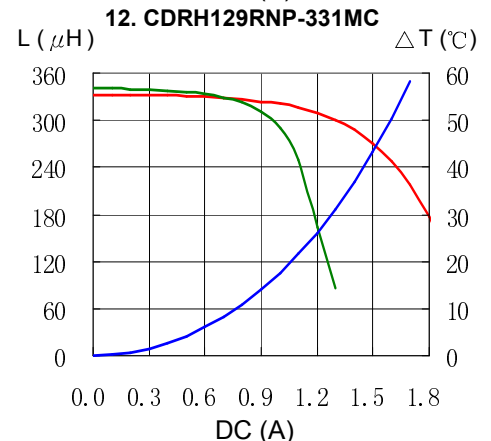
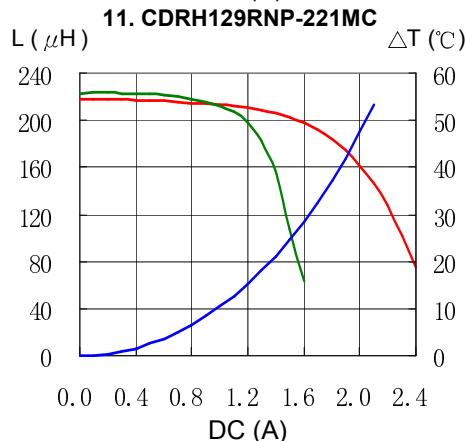
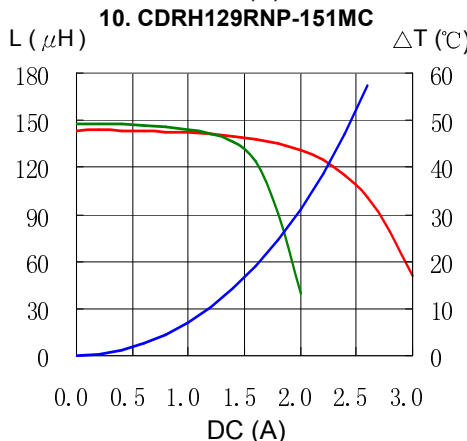
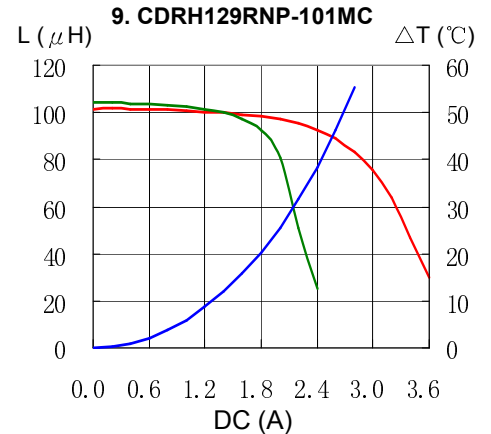
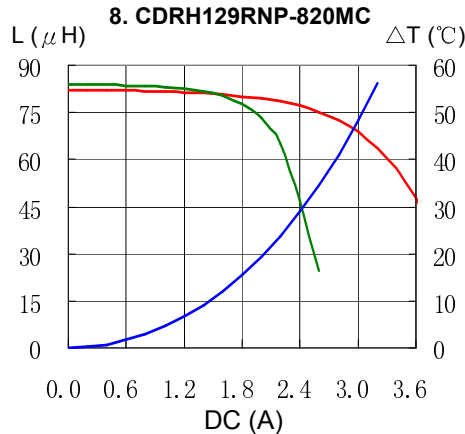
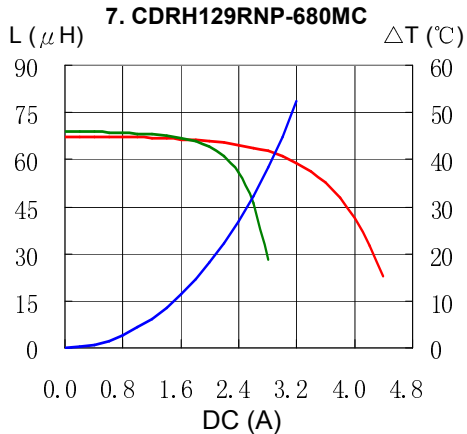
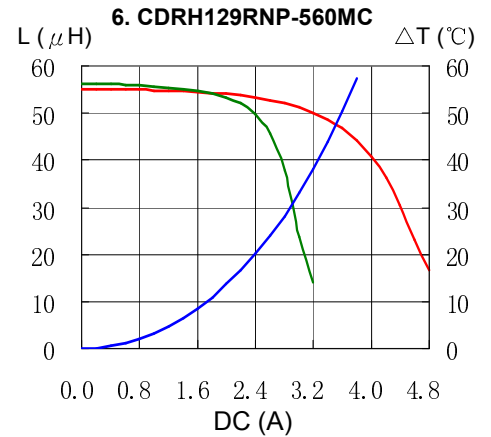
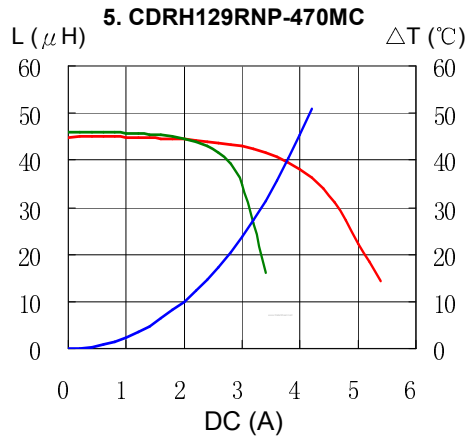
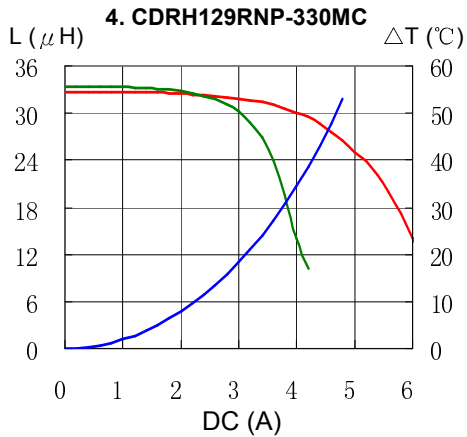
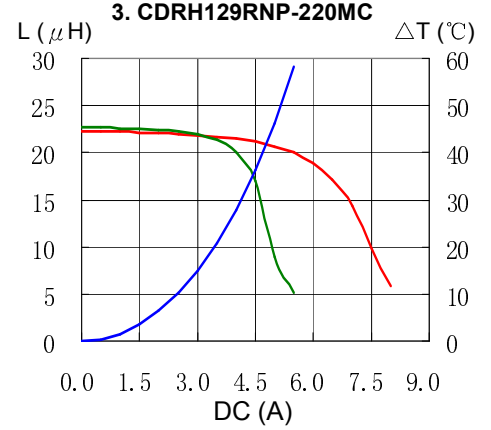
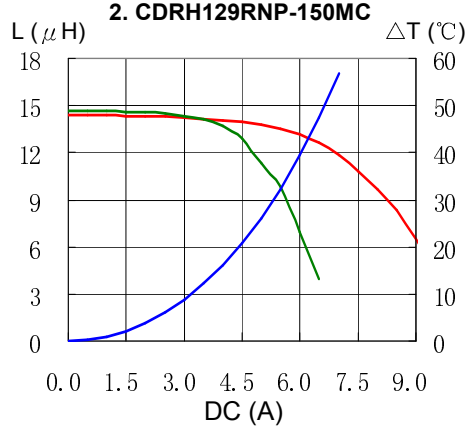
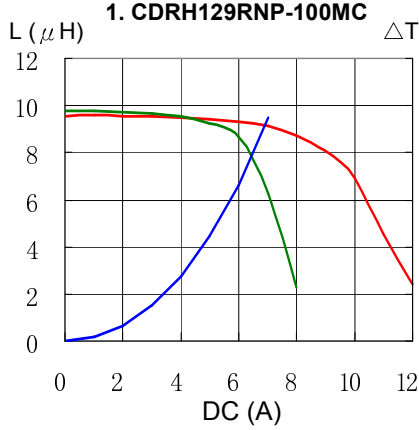

SMD Power Inductor CDRH129R

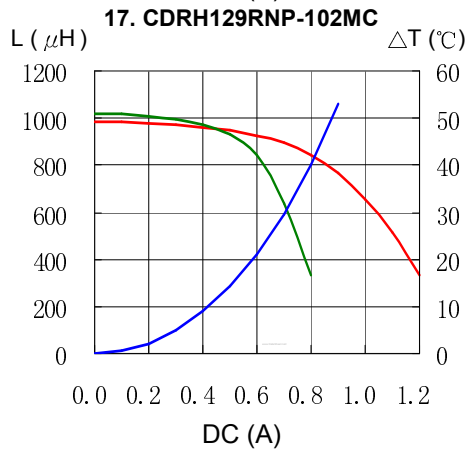
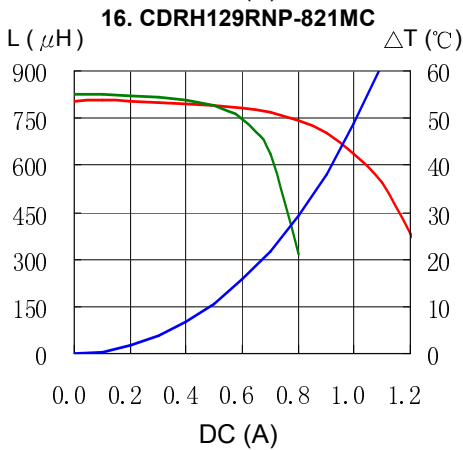
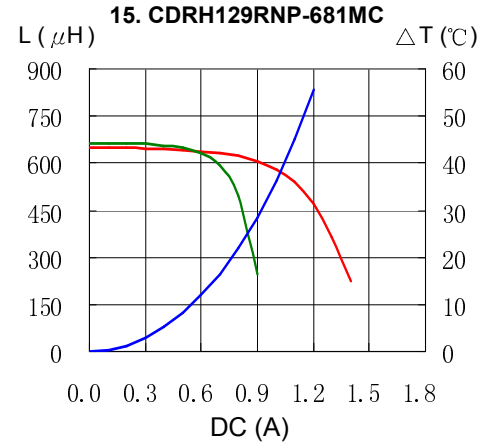
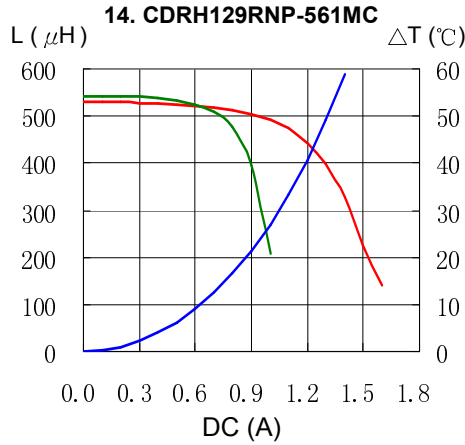
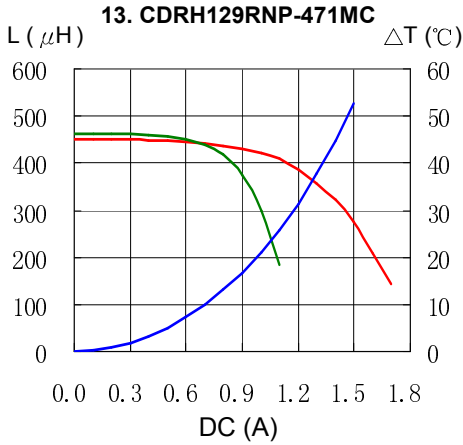
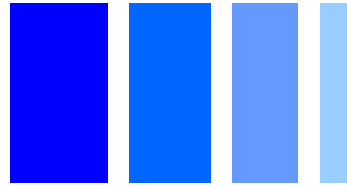

Solder Reflow Condition

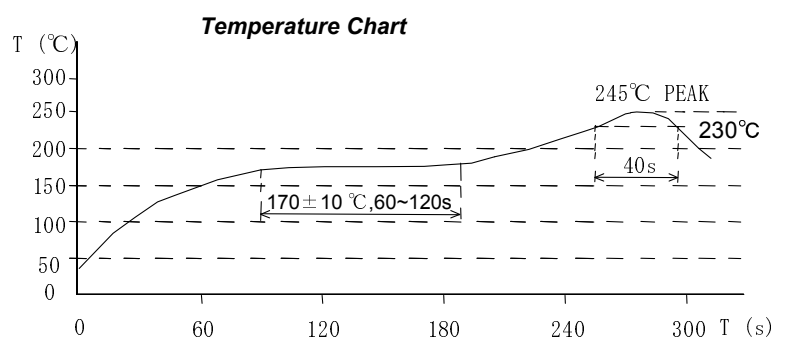
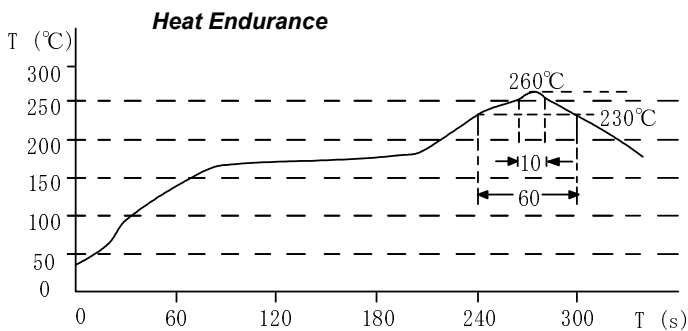

Please refer to the sales offices on our website - <http://www.sumida.com>

Hong Kong

Tel. +852-2880-6688
FAX. +852-2565-9600
sales@hk.sumida.com

Tokyo

Tel. +81-3-5202-7112
FAX. +81-3-5202-7105
sales@jp.sumida.com

Chicago

Tel. +1-847-545-6700
FAX. +1-847-545-6720
sales@us.sumida.com

Shanghai

Tel. +86-021-5836-3299
FAX. +86-021-5836-3266
shanghai.sales@cn.sumida.com

Seoul

Tel. +82-2-6237-0777
FAX. +82-2-6237-0778
sales@kr.sumida.com

Obernzell

Tel. +49-8591-937-0
FAX. +49-8591-937-103
contact@sumida-eu.com

Shenzhen

Tel. +86-755-8291-0228
FAX. +86-755-8291-0338
shenzhen.sales@cn.sumida.com

Singapore

Tel. +65-6296-3388
FAX. +65-6296-3390
sales@sg.sumida.com

Neumarkt

Tel. +49-9181-4509-110
FAX. +49-9181-4509-310
infocomp@eu.sumida.com

Taipei

Tel. +886-2-8751-2737
FAX. +886-2-8751-2738
sales@tw.sumida.com

San Jose

Tel. +1-408-3219660
FAX. +1-408-321-9308
sales@us.sumida.com