

SMD Power Inductor CDRH12D78R

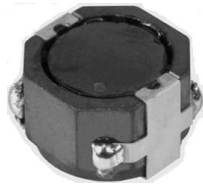

Description

- Ferrite drum core construction.
- Magnetically shielded.
- L × W × H: 12.4 × 12.4 × 8.0mm Max.
- Product weight: 4.1g(Ref.)
- Moisture Sensitivity Level: 1
- RoHS compliance.

Environmental Data

- Operating temperature range: -40°C ~ +105°C (including coil's self temperature rise)
- Storage temperature range: -40°C ~ +105°C
- Solder reflow temperature: 260 °C peak.

Packaging

- Carrier tape and reel packaging.
- 12.9" diameter reel
- 500pcs per reel

Applications

- Ideally used in Game machine, Notebook PC, LCD TV, DVD, STB, Projector etc as DC-DC converter inductors.

Dimension - [mm]

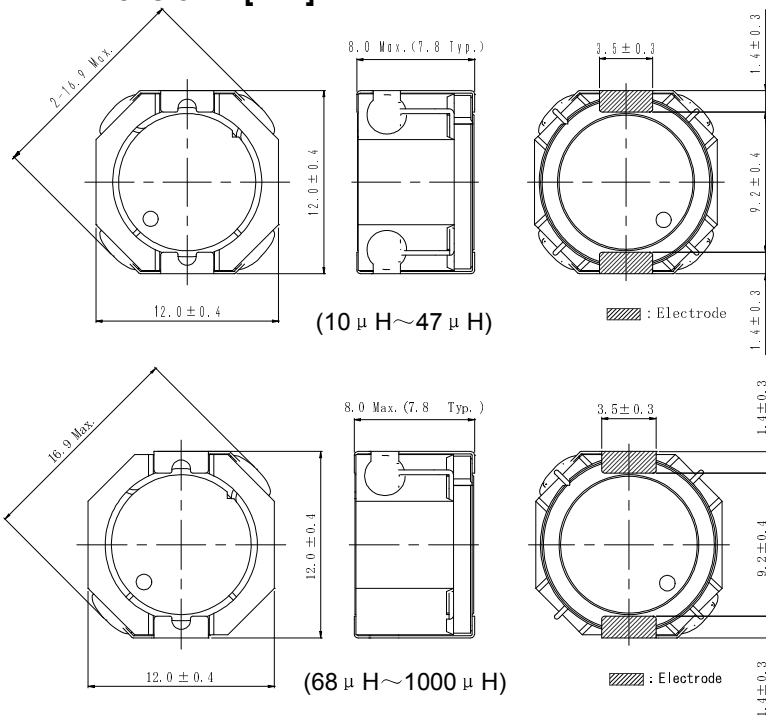

Land pattern and Schematics - [mm]

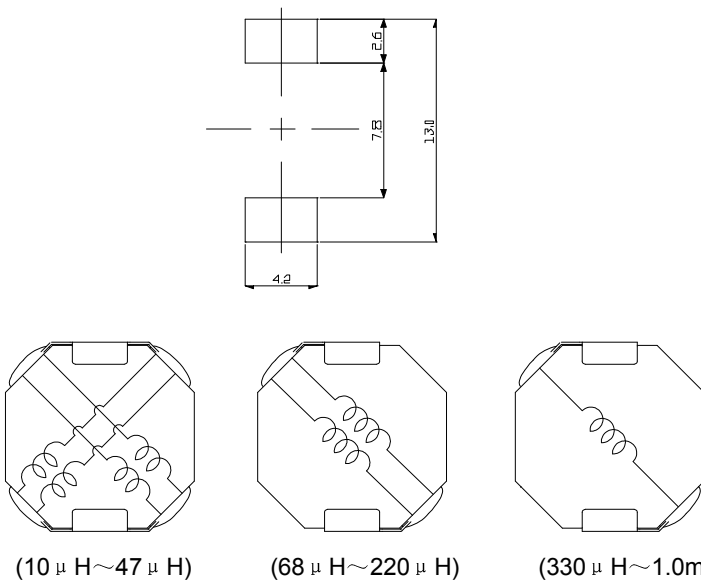

SMD Power Inductor CDRH12D78R



Electrical Characteristics

Part No.	Stamp	Inductance (μ H) [within] ※1	D.C.R. (m Ω) [Max.] (Typ.) (at 20°C)	Saturation Current (A) ※2		Temperature Rise Current (A) ※3
				at 20°C	at 105°C	
CDRH12D78RNP-100MC	100	10 \pm 20%	18.7(15)	10.1	6.60	5.90
CDRH12D78RNP-150MC	150	15 \pm 20%	23.8(19)	8.40	5.50	4.60
CDRH12D78RNP-220MC	220	22 \pm 20%	35.0(28)	6.80	4.40	3.80
CDRH12D78RNP-330MC	330	33 \pm 20%	50.0(40)	5.50	3.50	3.10
CDRH12D78RNP-470MC	470	47 \pm 20%	70.0(56)	4.60	3.05	2.55
CDRH12D78RNP-680MC	680	68 \pm 20%	93.8(75)	3.85	2.45	2.20
CDRH12D78RNP-101MC	101	100 \pm 20%	141.3(113)	3.15	2.10	1.80
CDRH12D78RNP-151MC	151	150 \pm 20%	218.8(175)	2.55	1.64	1.45
CDRH12D78RNP-221MC	221	220 \pm 20%	325.0(260)	2.08	1.38	1.09
CDRH12D78RNP-331MC	331	330 \pm 20%	470.0(376)	1.72	1.12	0.96
CDRH12D78RNP-471MC	471	470 \pm 20%	652.5(522)	1.42	0.92	0.84
CDRH12D78RNP-681MC	681	680 \pm 20%	928.8(743)	1.19	0.77	0.66
CDRH12D78RNP-102MC	102	1000 \pm 20%	1458(1167)	0.98	0.64	0.52

※1. Inductance measuring condition: at 100kHz.

※2. Saturation current: The value of D.C. current when the inductance decreases to 65% of its nominal value.

※3. Temperature rise current: The value of D.C. current when the temperature rise is $\Delta t=40^{\circ}\text{C}$ ($T_a=20^{\circ}\text{C}$).

SMD Power Inductor CDRH12D78R



Saturation Current & Temperature Rise Graph

— L (20°C) — L (100°C) — ΔT

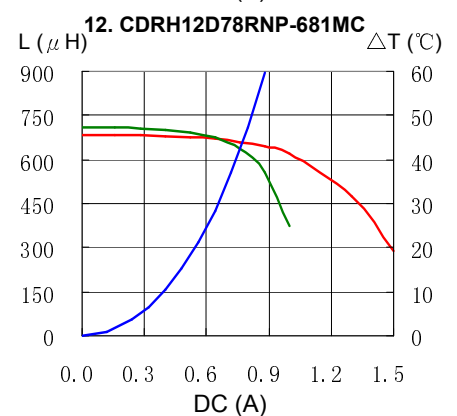
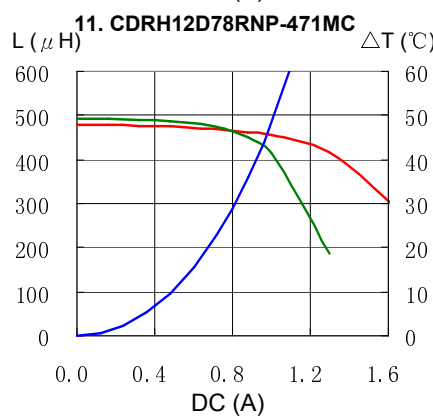
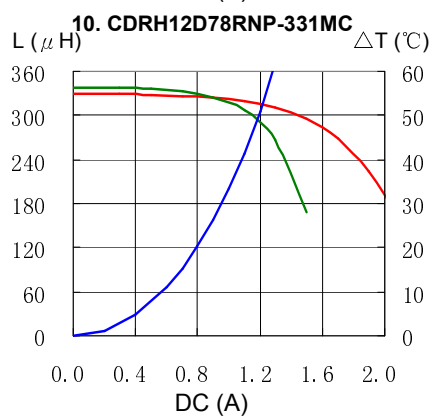
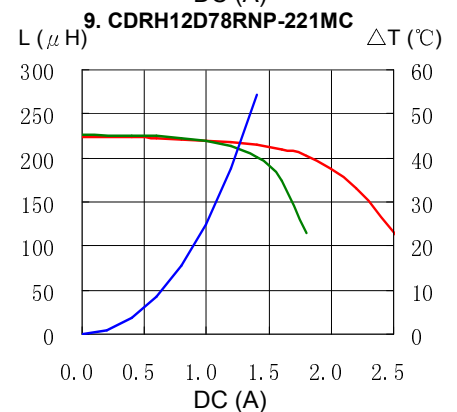
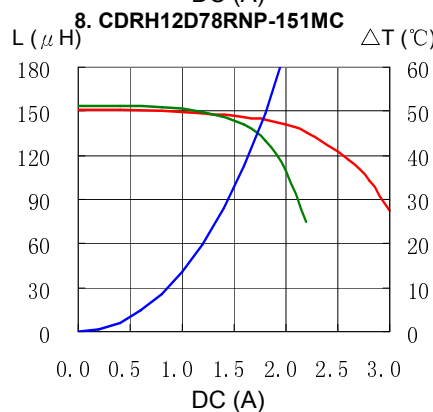
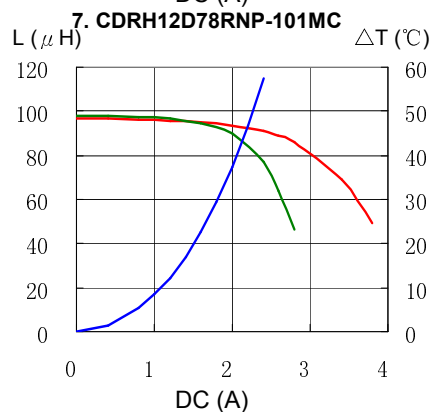
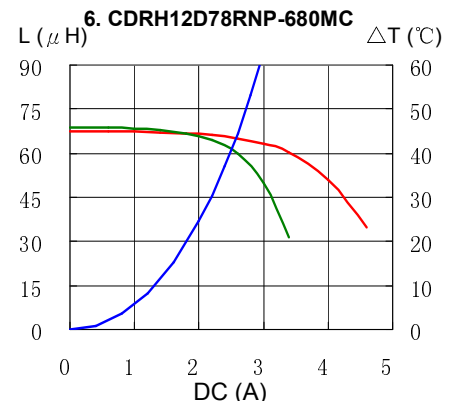
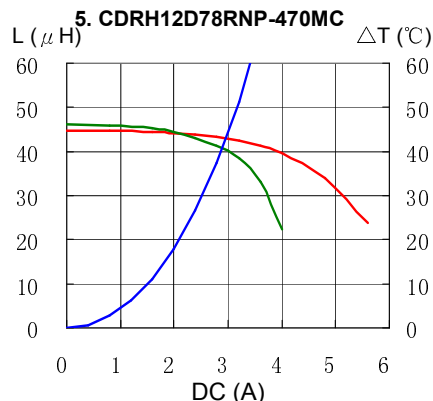
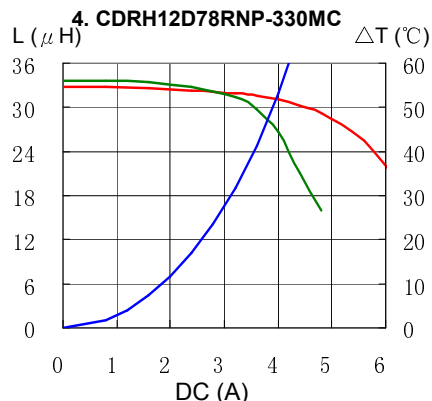
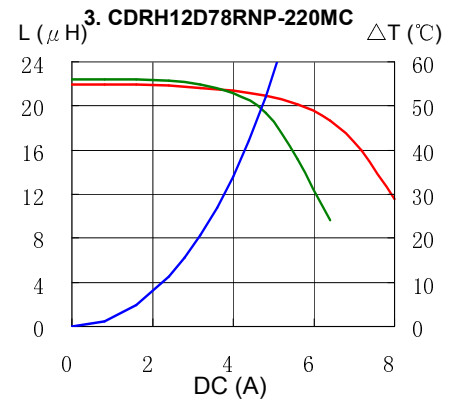
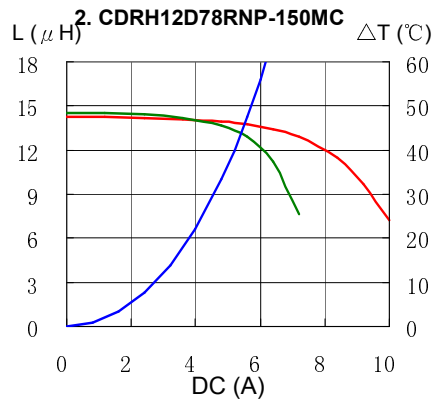
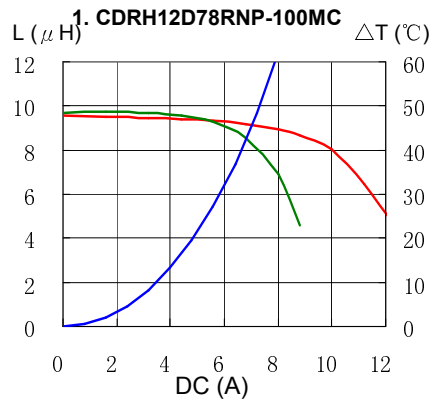

SMD Power Inductor CDRH12D78R



Saturation Current & Temperature Rise Graph

— L (20°C) — L (100°C) — ΔT

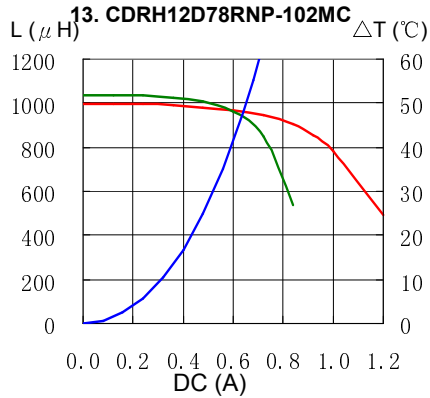

Solder Reflow Condition

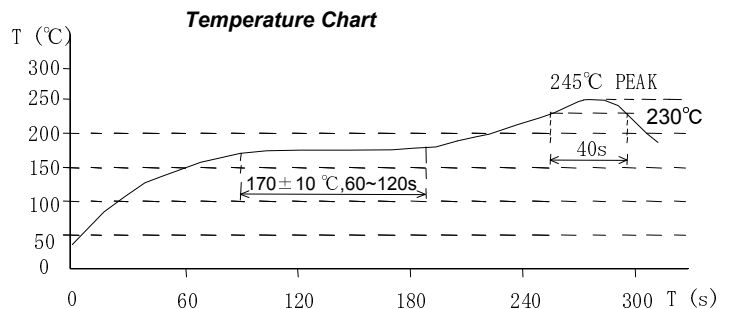
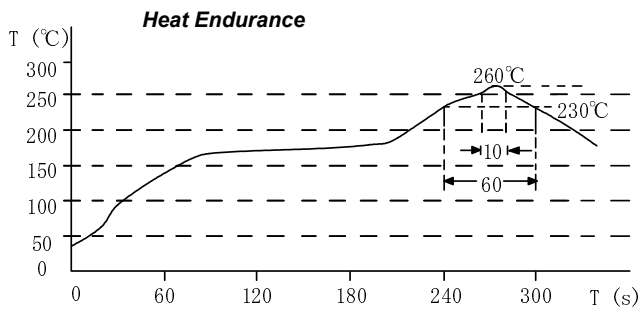

Please refer to the sales offices on our website - <http://www.sumida.com>

Hong Kong
Tel.+852-2880-6781
FAX.+852-2565-9600
sales@hk.sumida.com

Saitama(Japan)
Tel.+81-48-691-7300
FAX.+81-48-691-7340
sales@jp.sumida.com

Chicago
Tel.+1-847-545-6700
FAX. +1-847-545-6720
sales@us.sumida.com

Shanghai
Tel.+86-21-5836-3299
FAX.+86-21-5836-3266
shanghai.sales@cn.sumida.com

Seoul
Tel.+82-2-6237-0777
FAX.+82-2-6237-0778
sales@kr.sumida.com

Oberzell
Tel.+49-8591-937-0
FAX. +49-8591-937-103
contact@eu.sumida.com

Shenzhen
Tel.+86-755-8291-0228
FAX.+86-755-8291-0338
shenzhen.sales@cn.sumida.com

Singapore
Tel.+65-6296-3388
FAX.+65-6841-4426
sales@sg.sumida.com

Neumarkt
Tel.+49-9181-4509-110
FAX. +49-9181-4509-310
infocomp@eu.sumida.com

Taipei
Tel.+886-2-8751-2737
FAX.+886-2-8751-2738
sales@tw.sumida.com

San Jose
Tel.+1-408-321-9660
FAX.+1-408-321-9308
sales@us.sumida.com