

SMD Power Inductor CDRH4D18C



Halogen Free



Description

- Ferrite drum core construction.
- Magnetically shielded.
- L × W × H: 5.1 × 5.1 × 2.0 mm Max.
- Product weight: 135mg(Ref.)
- Moisture Sensitivity Level: 1
- RoHS compliance.
- Halogen Free available.

Environmental Data

- Operating temperature range: -40°C~+105°C (including coil's self temperature rise)
- Storage temperature range: -40°C~+105°C
- Solder reflow temperature: 260 °C peak.

Packaging

- Carrier tape and reel packaging
- 7.0" diameter reel
- 1000pcs per reel

Applications

- Ideally used in Mobile phone, PDA, MP3, HDD, DSC/DVC, Note book PC, etc as DC-DC converter inductors.

Dimension - [mm]

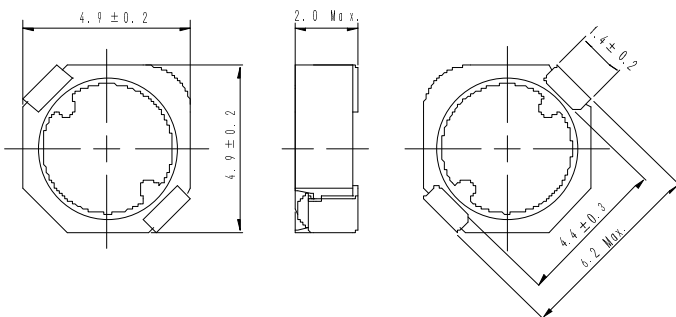

Land pattern and Schematics - [mm]

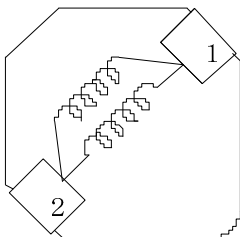
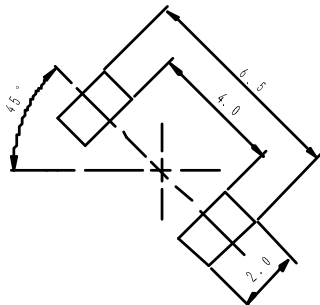

(1.1 μ H ~ 6.8 μ H)

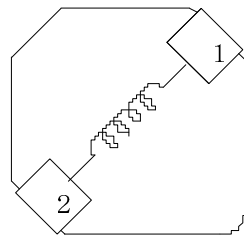

(10 μ H ~ 100 μ H)

SMD Power Inductor

CDRH4D18C



Electrical Characteristics

Part No.	Stamp	Inductance (μ H) [within] ※1	D.C.R.(Ω) Max. (Typ.) (at 20°C)	Rated Current (A) ※2
CDRH4D18CNP-1R1PC	A	1.1 \pm 25%	29m(23m)	2.4
CDRH4D18CNP-2R2PC	B	2.2 \pm 25%	39m(31m)	1.7
CDRH4D18CNP-3R0PC	C	3.0 \pm 25%	61m(49m)	1.5
CDRH4D18CNP-4R7PC	D	4.7 \pm 25%	110m(88m)	1.15
CDRH4D18CNP-6R8PC	E	6.8 \pm 25%	125m(100m)	1.05
CDRH4D18CNP-100PC	F	10 \pm 25%	156m(125m)	830m
CDRH4D18CNP-150PC	G	15 \pm 25%	194m(155m)	700m
CDRH4D18CNP-220PC	H	22 \pm 25%	323m(258m)	600m
CDRH4D18CNP-330PC	I	33 \pm 25%	550m(440m)	460m
CDRH4D18CNP-470PC	J	47 \pm 25%	783m(626m)	410m
CDRH4D18CNP-680PC	K	68 \pm 25%	1.16(925m)	305m
CDRH4D18CNP-101PC	L	100 \pm 25%	1.51(1.21)	250m

※1. Inductance measuring condition: at 100kHz.

※2. Rated current: The DC current at which the inductance decreases to 65% of its nominal value or when $\Delta t=40^{\circ}\text{C}$, whichever is lower ($T_a=20^{\circ}\text{C}$).

SMD Power Inductor CDRH4D18C

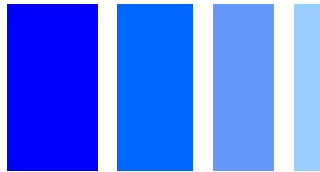

Saturation Current & Temperature Rise Graph

— L (20°C) — L (100°C) — ΔT

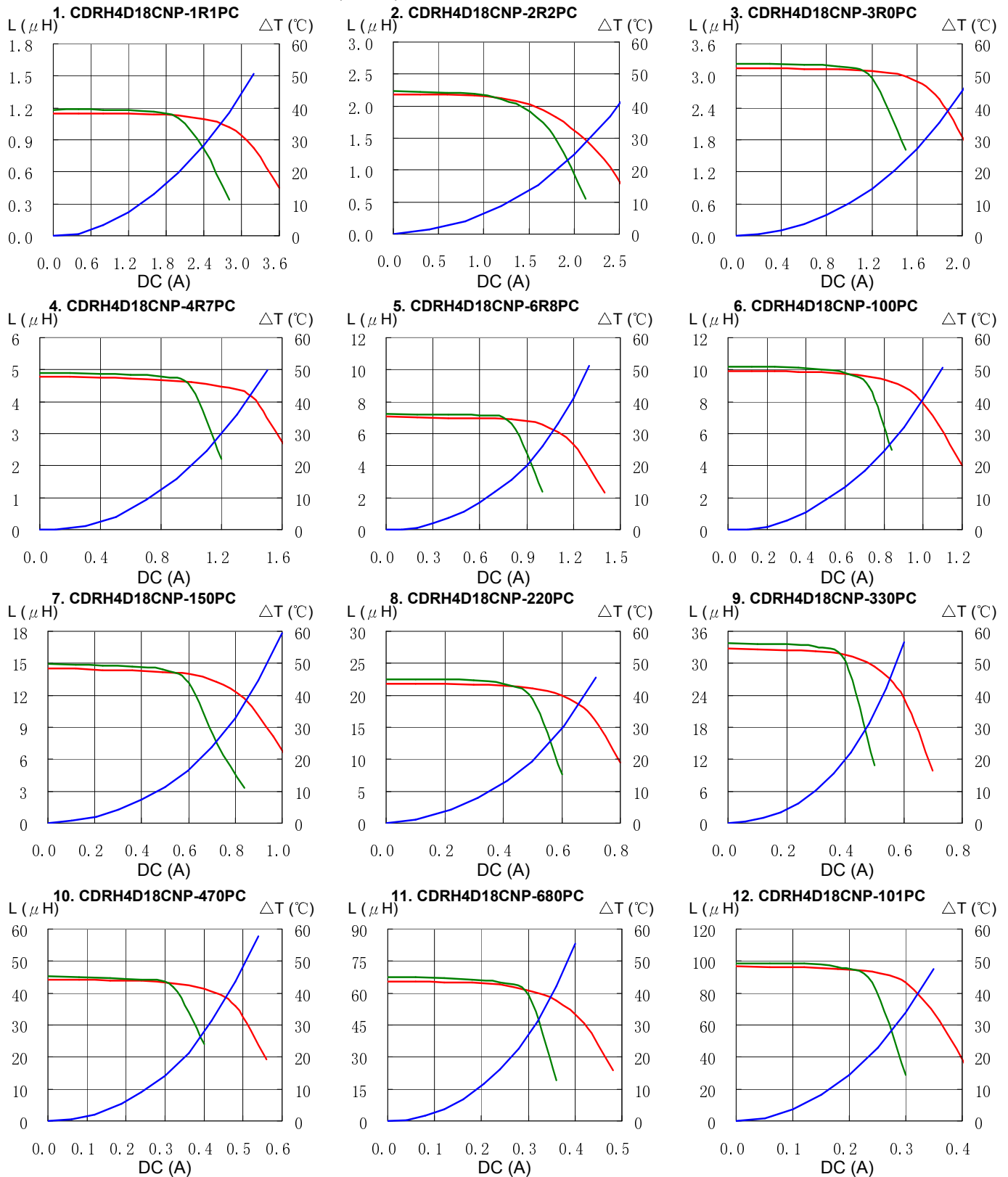

SMD Power Inductor CDRH4D18C



Solder Reflow Condition

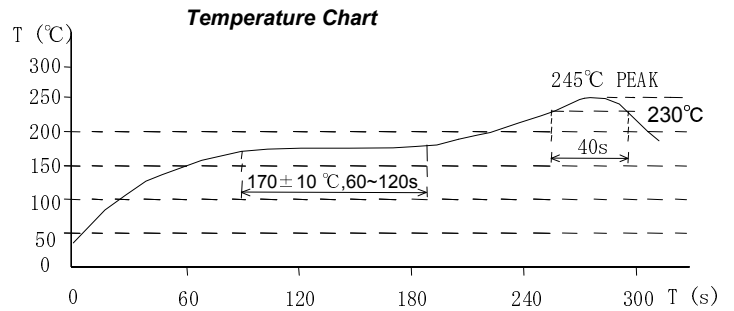
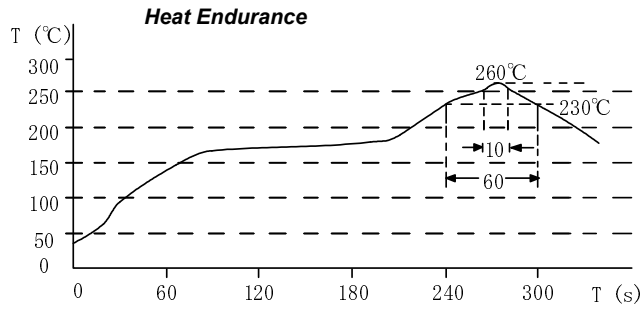

Please refer to the sales offices on our website - <http://www.sumida.com>

Hong Kong

Tel.+852-2880-6781
FAX.+852-2565-9600
sales@hk.sumida.com

Saitama(Japan)

Tel.+81-48-691-7300
FAX.+81-48-691-7340
sales@jp.sumida.com

Chicago

Tel.+1-847-545-6700
FAX. +1-847-545-6720
sales@us.sumida.com

Shanghai

Tel.+86-21-5836-3299
FAX.+86-21-5836-3266
shanghai.sales@cn.sumida.com

Seoul

Tel.+82-2-6237-0777
FAX.+82-2-6237-0778
sales@kr.sumida.com

Oberzell

Tel.+49-8591-937-0
FAX. +49-8591-937-103
contact@eu.sumida.com

Shenzhen

Tel.+86-755-8291-0228
FAX.+86-755-8291-0338
shenzhen.sales@cn.sumida.com

Singapore

Tel.+65-6296-3388
FAX.+65-6841-4426
sales@sg.sumida.com

Neumarkt

Tel.+49-9181-4509-110
FAX. +49-9181-4509-310
infocomp@eu.sumida.com

Taipei

Tel.+886-2-8751-2737
FAX.+886-2-8751-2738
sales@tw.sumida.com

San Jose

Tel.+1-408-321-9660
FAX.+1-408-321-9308
sales@us.sumida.com